

## SERVICE MANUAL

MODEL	JP	E3	E2	EK	E2A	E1C	E1K	EUT
S-302	✓	✓	✓					

### DVD HOME ENTERTAINMENT SYSTEM

HOME THEATER SYSTEM (S-302) consists of DVD SURROUND RECEIVER (ADV-S302), SUB WOOFER (DSW-S302) and SPEAKER SYSTEM (SC-S302)

#### 注意

サービスをおこなう前に、このサービスマニュアルを必ずお読みください。本機は、火災、感電、けがなどに対する安全性を確保するために、さまざまな配慮をおこなっており、また法的には「電気用品安全法」にもとづき、所定の許可を得て製造されております。従ってサービスをおこなう際は、これらの安全性が維持されるよう、このサービスマニュアルに記載されている注意事項を必ずお守りください。

• For purposes of improvement, specifications and design are subject to change without notice.

• 本機の仕様は性能改良のため、予告なく変更することがあります。  
• 補修用性能部品の保有期間は、製造打切後 8 年です。

• Please use this service manual with referring to the operating instructions without fail.

• 修理の際は、必ず取扱説明書を参照の上、作業を行ってください。

• Some illustrations using in this service manual are slightly different from the actual set.

• 本文中に使用しているイラストは、説明の都合上現物と多少異なる場合があります。

# DENON

TOKYO, JAPAN  
Denon Brand Company, D&M Holdings Inc.

## SAFETY PRECAUTIONS

The following check should be performed for the continued protection of the customer and service technician.

### LEAKAGE CURRENT CHECK

Before returning the unit to the customer, make sure you make either (1) a leakage current check or (2) a line to chassis resistance check. If the leakage current exceeds 0.5 milliamps, or if the resistance from chassis to either side of the power cord is less than 460 kohms, the unit is defective.

### LASER RADIATION

Do not stare into beam or view directly with optical instruments, class 3A laser product.

**CAUTION** Please heed the points listed below during servicing and inspection.

#### ◎ Heed the cautions!

Spots requiring particular attention when servicing, such as the cabinet, parts, chassis, etc., have cautions indicated on labels or seals. Be sure to heed these cautions and the cautions indicated in the handling instructions.

#### ◎ Caution concerning electric shock!

(1) An AC voltage is impressed on this set, so touching internal metal parts when the set is energized could cause electric shock. Take care to avoid electric shock, by for example using an isolating transformer and gloves when servicing while the set is energized, unplugging the power cord when replacing parts, etc.

(2) There are high voltage parts inside. Handle with extra care when the set is energized.

#### ◎ Caution concerning disassembly and assembly!

Though great care is taken when manufacturing parts from sheet metal, there may in some rare cases be burrs on the edges of parts which could cause injury if fingers are moved across them. Use gloves to protect your hands.

#### ◎ Only use designated parts!

The set's parts have specific safety properties (fire resistance, voltage resistance, etc.). For replacement parts, be sure to use parts which have the same properties. In particular, for the important safety parts that are marked  on wiring diagrams and parts lists, be sure to use the designated parts.

#### ◎ Be sure to mount parts and arrange the wires as they were originally!

For safety reasons, some parts use tape, tubes or other insulating materials, and some parts are mounted away from the surface of printed circuit boards. Care is also taken with the positions of the wires inside and clamps are used to keep wires away from heating and high voltage parts, so be sure to set everything back as it was originally.

#### ◎ Inspect for safety after servicing!

Check that all screws, parts and wires removed or disconnected for servicing have been put back in their original positions, inspect that no parts around the area that has been serviced have been negatively affected, conduct an insulation check on the external metal connectors and between the blades of the power plug, and otherwise check that safety is ensured.

(Insulation check procedure)

Unplug the power cord from the power outlet, disconnect the antenna, plugs, etc., and turn the power switch on. Using a 500V insulation resistance tester, check that the insulation resistance between the terminals of the power plug and the externally exposed metal parts (antenna terminal, headphones terminal, microphone terminal, input terminal, etc.) is 1MΩ or greater. If it is less, the set must be inspected and repaired.

### CAUTION Concerning important safety parts

Many of the electric and structural parts used in the set have special safety properties. In most cases these properties are difficult to distinguish by sight, and using replacement parts with higher ratings (rated power and withstand voltage) does not necessarily guarantee that safety performance will be preserved. Parts with safety properties are indicated as shown below on the wiring diagrams and parts lists in this service manual. Be sure to replace them with parts with the designated part number.

(1) Schematic diagrams ... Indicated by the  mark.

(2) Parts lists ... Indicated by the  mark.

Using parts other than the designated parts could result in electric shock, fires or other dangerous situations.

**注意** サービス、点検時にはつぎのことにご注意願います。

#### ◎注意事項をお守りください！

サービスのとき特に注意を必要とする個所についてはキャビネット、部品、シャーシなどにラベルや捺印で注意事項を表示しています。これらの注意書きおよび取扱説明書などの注意事項を必ずお守りください。

#### ◎感電に注意！

(1) このセットは、交流電圧が印加されていますので通電時に内部金属部に触れると感電することがあります。従って通電サービス時には、絶縁トランスの使用や手袋の着用、部品交換には、電源プラグを抜くなどして感電にご注意ください。

(2) 内部には高電圧の部分がありますので、通電時の取扱には十分ご注意ください。

#### ◎分解、組み立て作業時のご注意！

板金部品の端面の『バリ』は、部品製造時に充分管理をしておりますが、板金端面は鋭利となっている箇所がありますので、部品端面に触れたまま指を動かすとまれに怪我をする場合がありますので十分注意して作業して下さい。手の保護のために手袋を着用してください。

#### ◎指定部品の使用！

セットの部品は難燃性や耐電圧など安全上の特性を持ったものとなっています。従って交換部品は、使用されていたものと同じ特性の部品を使用してください。特に配線図、部品表に  印で指定されている安全上重要な部品は必ず指定のものをご使用ください。

#### ◎部品の取付けや配線の引きまわしは、元どおりに！

安全上、テープやチューブなどの絶縁材料を使用したり、プリント基板から浮かして取付けた部品があります。また内部配線は引きまわしやクランプによって発熱部品や高圧部品に接近しないように配慮されていますので、これらは必ず元どおりにしてください。

#### ◎サービス後は安全点検を！

サービスのために取り外したねじ、部品、配線などが元どおりになっているか、またサービスした個所の周辺を劣化させてしまったところがないかなどを点検し、外部金属端子部と、電源プラグの刃の間の絶縁チェックをおこなうなど、安全性が確保されていることを確認してください。

(絶縁チェックの方法)

電源コンセントから電源プラグを抜き、アンテナやプラグなどを外し、電源スイッチを入れます。500V 絶縁抵抗計を用いて、電源プラグのそれぞれの端子と外部露出金属部 [アンテナ端子、ヘッドホン端子、マイク端子、入力端子など] との間で、絶縁抵抗値が 1 MΩ 以上であること、この値以下のときはセットの点検修理が必要です。

### 注意 安全上重要な部品について

本機に使用している多くの電気部品、および機構部品は安全上、特別な特性を持っています。この特性はほとんどの場合、外観では判別つきにくく、またもとの部品より高い定格(定格電力、耐圧)を持ったものを使用しても安全性が維持されるとは、限りません。安全上の特性を持った部品は、このサービスマニュアルの配線図、部品表につぎのように表示していますので必ず指定されている部品番号のものを使用願います。

(1) 配線図...  マークで表示しています。

(2) 部品表...  マークで表示しています。

指定された部品と異なるものを使用した場合には、感電、火災などの危険を生じる恐れがあります。

# DIMENSION

## ADV-S302

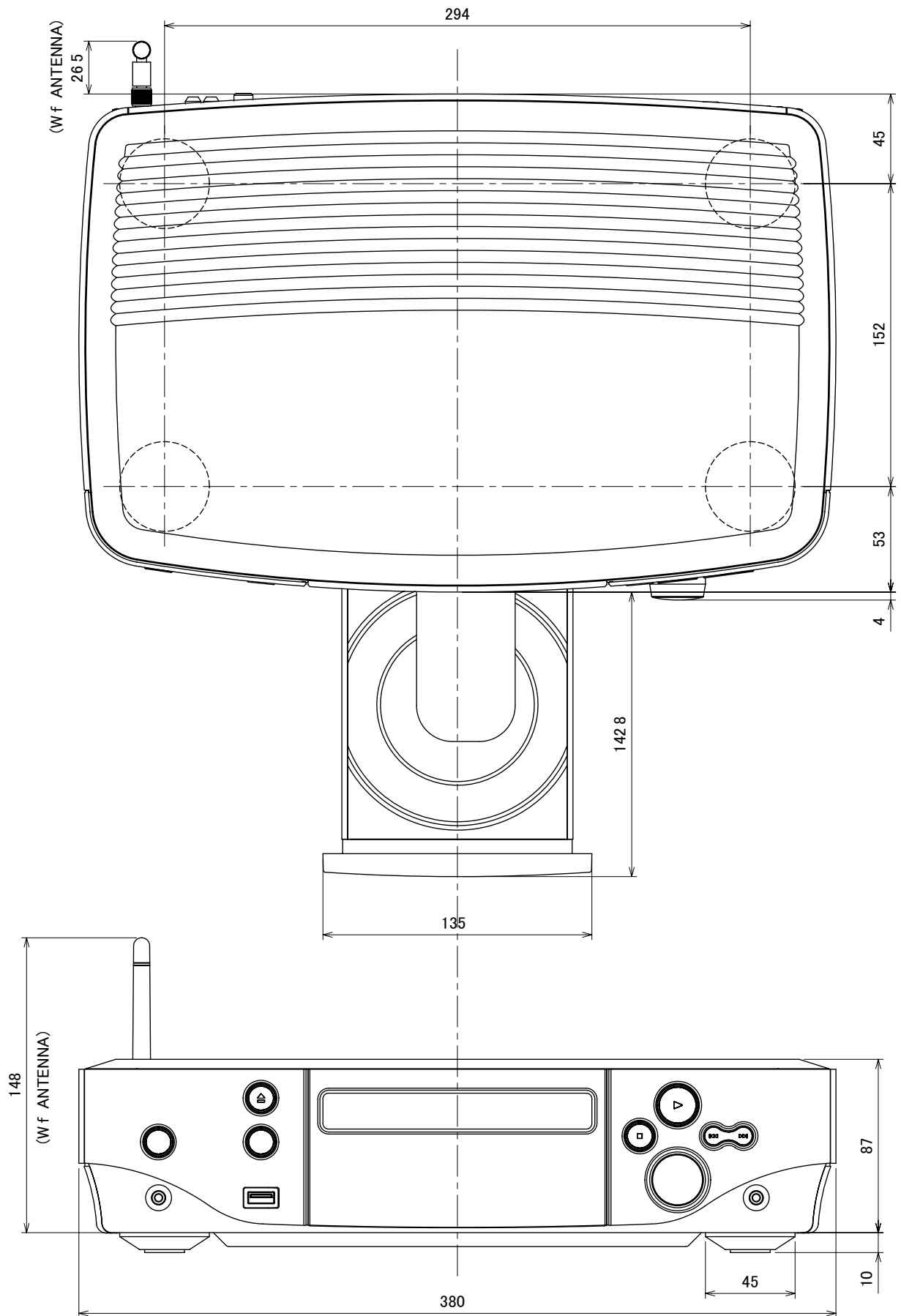

DSW-S302

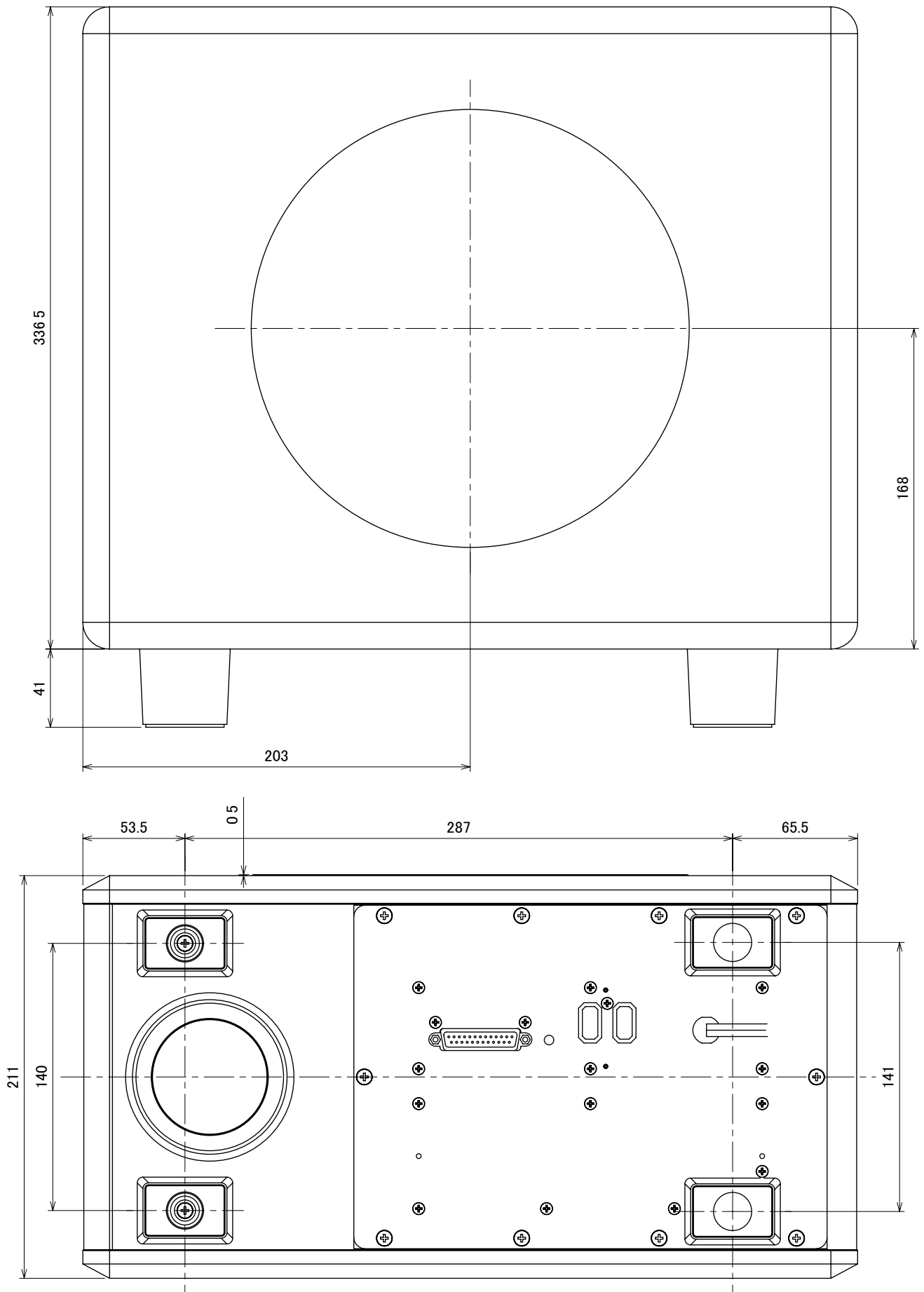



SC-S302

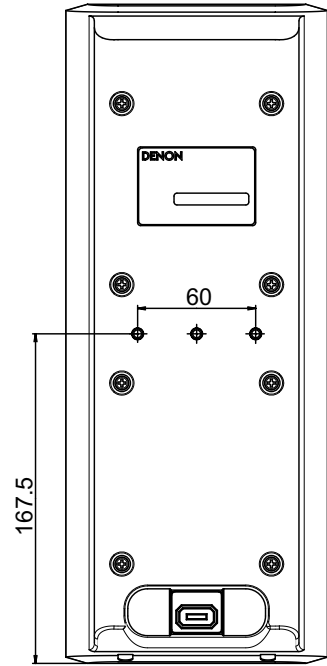
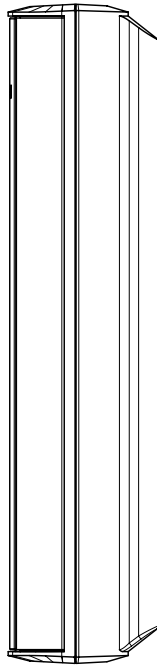
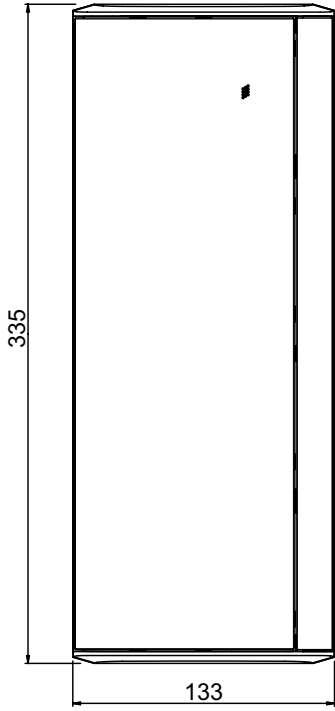
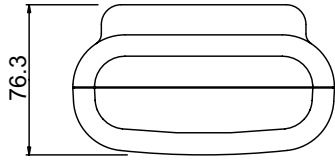

## WIRE ARRANGEMENT

If wire bundles are untied or moved to perform adjustment or parts replacement etc., be sure to rearrange them neatly as they were originally bundled or placed afterward. Otherwise, incorrect arrangement can be a cause of noise generation.

### 1. ADV-S302

- ① Fasten the CX31 3P connector cord to the circuit board with a style pin.
- ② Fasten the CX33 3P connector cord and CY072 7P connector cord to the circuit board with a style pin and clamp band.
- ③ Pass the CY211 FFC through the protect sheet.
- ④ Pass the CW052 5P connector cord through the protect sheet.
- ⑤ Fasten the CW051 5P connector cord and CW052 5P connector cord to the circuit board with a cord holder.

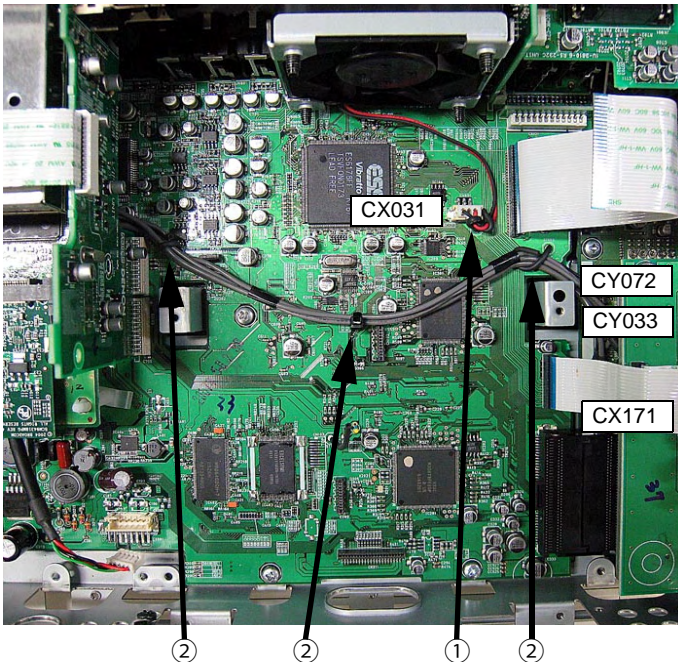

- ⑥ Pass the antenna cable next to the CX154 FFC.
- ⑦ Fasten the CW051 5P connector cord and CW052 5P connector cord with a cord holder.

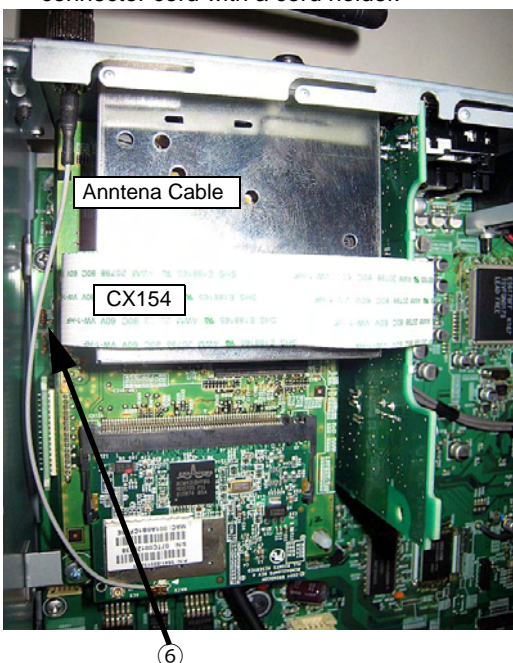

## ワイヤー整形図

調整や部品の交換等により、ワイヤー類の結束をはずしたり移動させた場合には、それらの作業が完了した時点でワイヤーの整形をおこなってください。正しく整形されてないとノイズ発生の原因となることがあります。

### 1. ADV-S302

- ① CX031 3P コネクターコードをスタイルピンで基板に固定する。
- ② CY033 3P コネクターコードと CY072 7P コネクターコードをスタイルピンとクランプバンドで基板に固定する。
- ③ CY211 の FFC を Protect Sheet に通す。
- ④ CW052 5P コネクターコードを Protect Sheet に通す。
- ⑤ CW051 5P コネクターコードと CW052 5P コネクターコードをコードホルダーで基板に固定する。

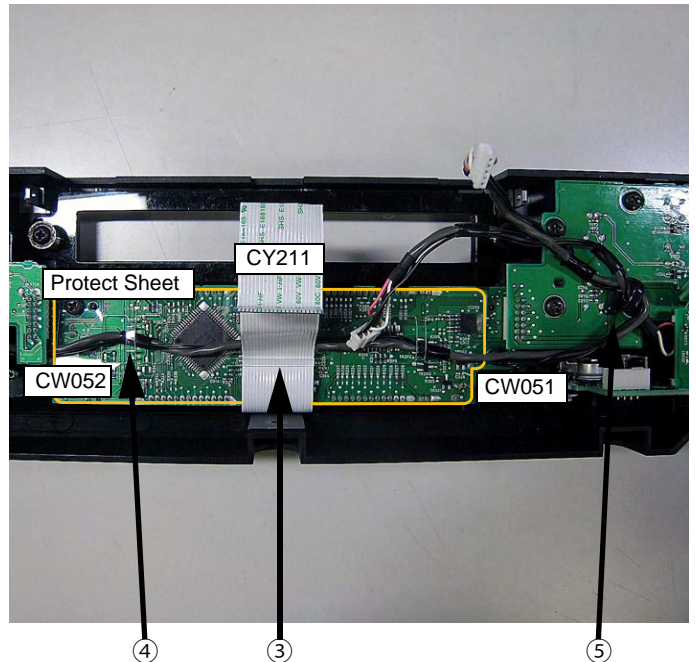

- ⑥ Antenna Cable は CX154 の FFC の横を通す。
- ⑦ CW051 5P コネクターコードと CW052 5P コネクターコードをコードホルダーで固定する。

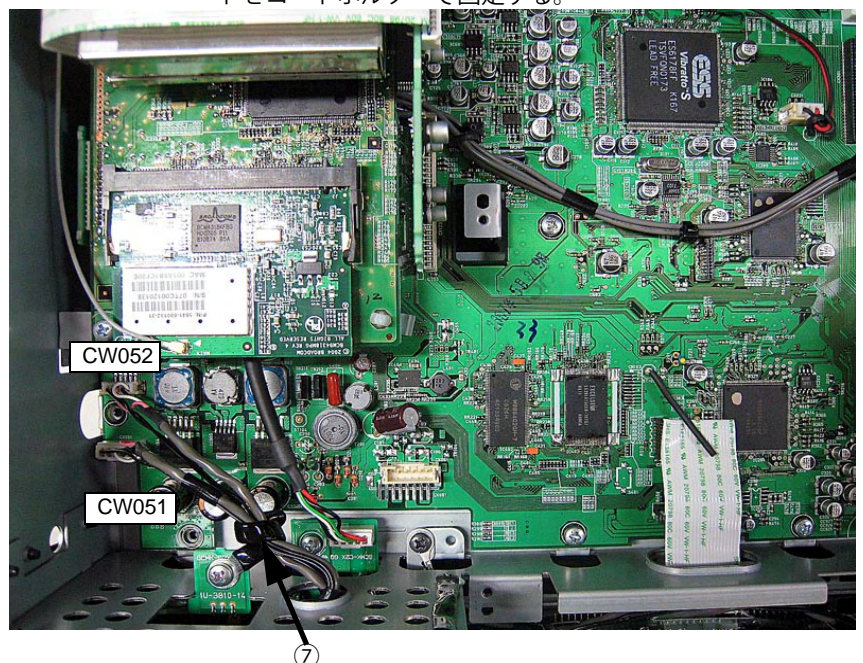



⑧ Fasten the CX061 6P connector cord with a cord holder.

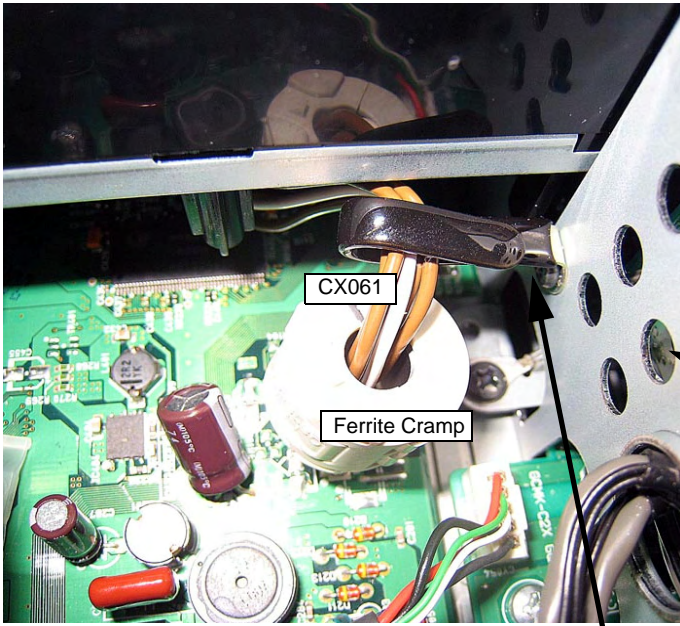

⑧ CX061 6P コネクターコードをコードホルダーで固定する。

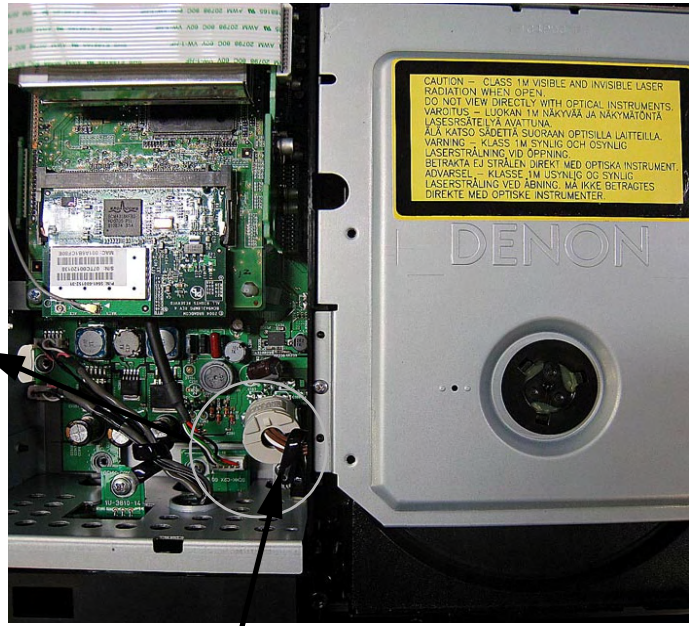

## 2. DSW-302

- ① Fasten the CX041 4P connector cord to the chassis with a clamp band.
- ② Fasten the CW041 4P connector cord and CX081 8P connector cord to the chassis with a clamp band.
- ③ Fasten with a clamp band.
- ④ Fasten the CX021 2P connector cord to the chassis with a clamp band.

## 2. DSW-302

- ① CX041 4P コネクターコードをクランプバンドでシャーシに固定。
- ② CW041 4P コネクターコードと CX081 8P コネクターコードをクランプバンドでシャーシに固定。
- ③ クランプバンドで結束。
- ④ CX021 2P コネクターコードをクランプバンドでシャーシに固定。

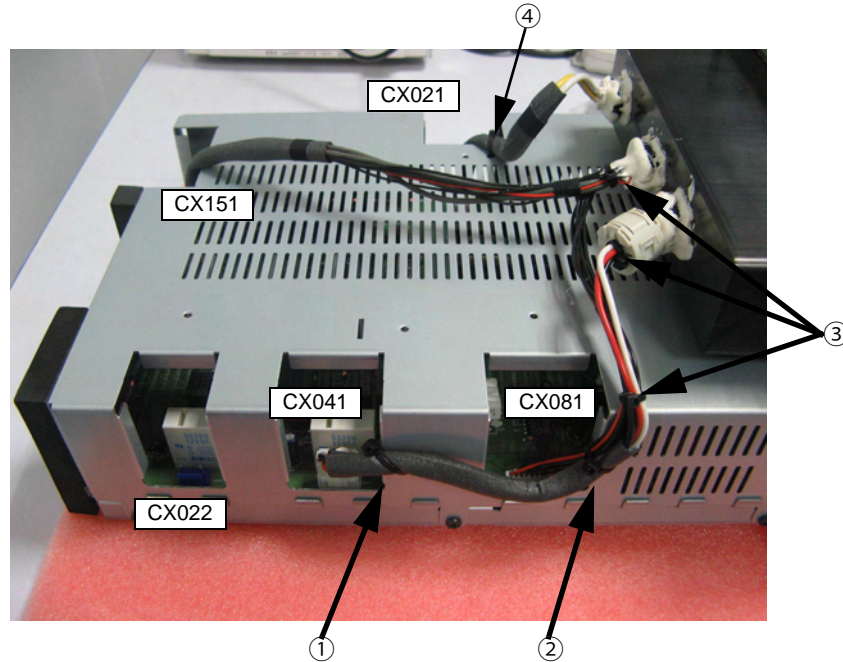

## DISASSEMBLY

(Follow the procedure below in reverse order when reassembling.)

### ● ADV-S302

#### 1. Side panel

- (1) Remove 4 screws 104 on the rear side and 4 screws 104 on the bottom side.
- (2) Detach the Side panel.

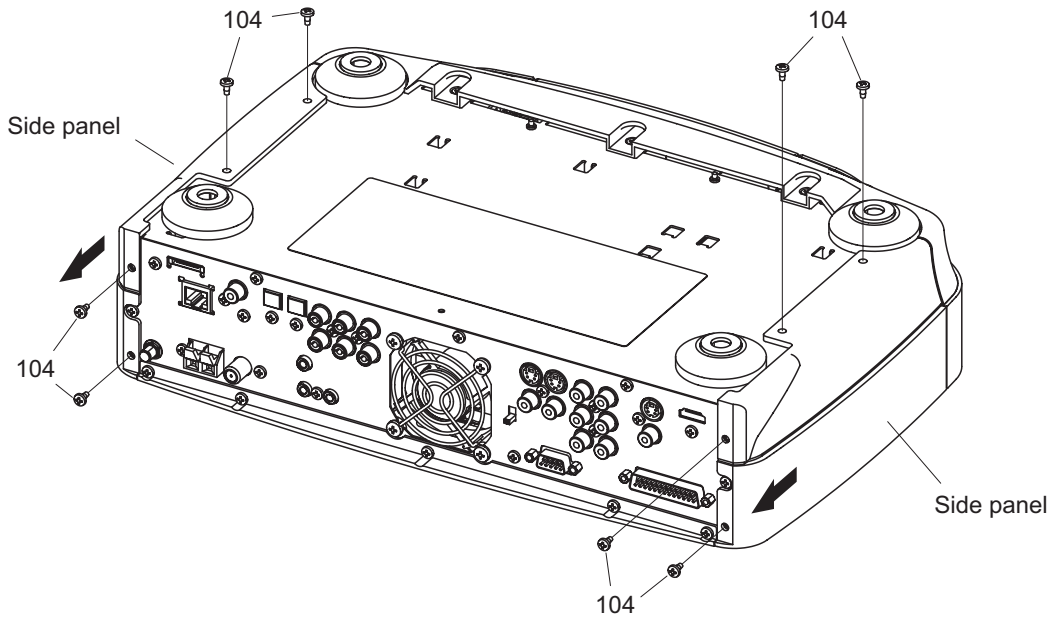

#### 2. Top cover

- (1) Remove 3 screws 104 on the rear side and 6 screws 105 on the both sides.
- (2) Detach the Top cover.

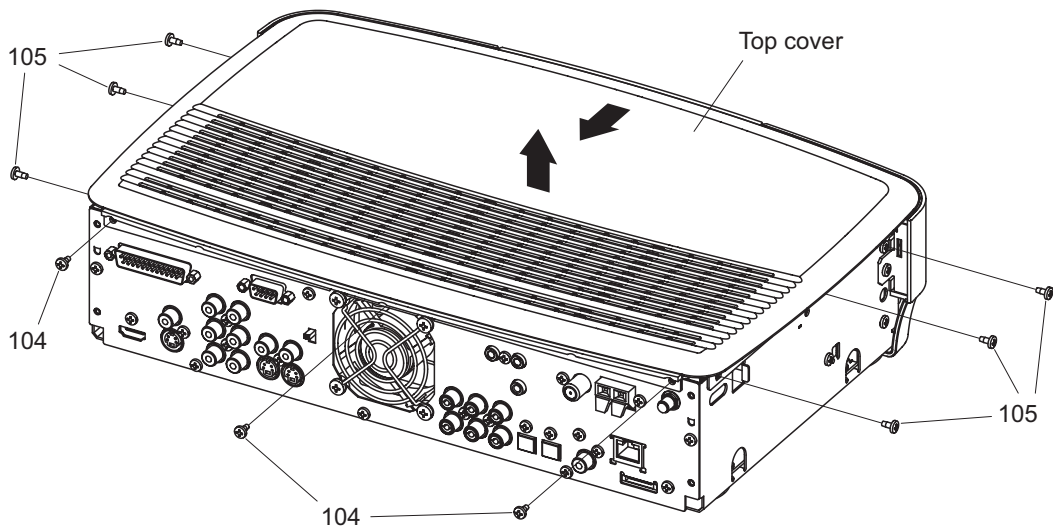

## 各部のはずしかた

(組み立てるときは、逆の順序でおこなってください。)

### ● ADV-S302

#### 1. Side panel

- (1) 背面側から 104 のねじ 4 本と底面側から 104 のねじ 4 本をはずします。
- (2) Side panel をはずします。

#### 2. Top cover

- (1) 背面側から 104 のねじ 3 本と側面側から 105 のねじ 6 本をはずします。
- (2) Top cover をはずします。

### 3. Drive unit

#### 3.1. When the Disc tray can be ejected electrically.

- (1) Switch on, and press [▲ (OPEN/CLOSE)] button to open the Disc tray.
- (2) Detach the Loader panel by lifting.
- (3) Close the Disc tray.
- (4) Remove 4 screws 102 on the top side.
- (5) Disconnect the Wire [CX061] from the Main unit and the FFC cable [CY301] from the Drive unit.
- (6) Detach the Drive unit

#### 3.2. When the Disc tray cannot be ejected electrically.

- (1) Push the Plate Gear of the Drive unit from direction of arrow A, to open the Disc Tray.
- (2) The same steps described on 3.1. (2)~(6).

### 3. Drive unit

#### 3.1. ディスクトレイが電源でオープン出来る場合

- (1) 電源を入れ「▲(OPEN/CLOSE)」ボタンを押して、ディスクトレイを開きます。
- (2) Loader Panel を持ち上げてはずします。
- (3) ディスクトレイを閉じます。
- (4) 天面側から 102 のねじ 4 本をはずします。
- (5) Main unit からワイヤー [CX061] と Drive unit から FFC ケーブル [CY301] をはずします。
- (6) Drive unit をはずします。

#### 3.2. ディスクトレイが電源でオープン出来ない場合

- (1) 矢印 A 方向から Drive unit のプレートギアを押してディスクトレイを開きます。
- (2) 3.1. (2) ~ (6) の作業に同じ。

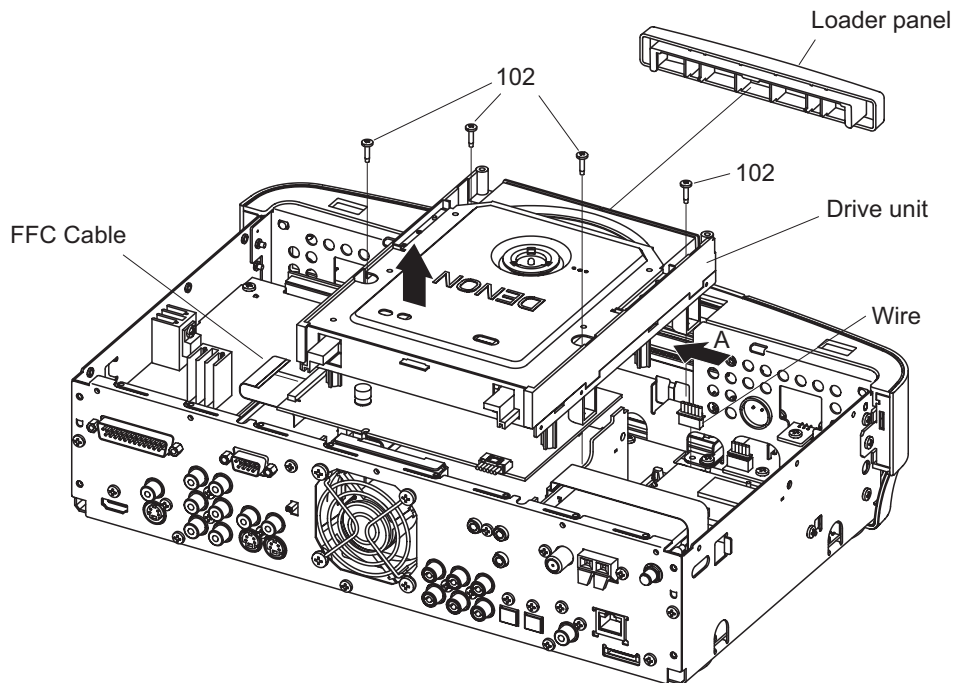

#### 4. Front panel assy

- (1) Remove 3 screws 106 on the bottom side.
- (2) Disconnect the Wire [CX051],[CX052] and the FFC cable [CX211] from the Main unit and the Wire [CX054] from the USB unit.
- (3) Remove 3 screws 103 and 2 screws 105 on the top side and 2 screws 105 on the both sides.
- (4) Detach the Front panel assy.

#### 4. Front panel assy

- (1) 底面側から 106 のねじ 3 本をはずします。
- (2) Main unit からワイヤー [CX051]、[CX052] と FFC ケーブル [CX211] を USB キャンからワイヤー [CY054] をはずします。
- (3) 天面側から 103 のねじ 3 本と 105 のねじ 2 本を側面側から 105 のねじ 2 本をはずします。
- (4) Front panel assy をはずします。

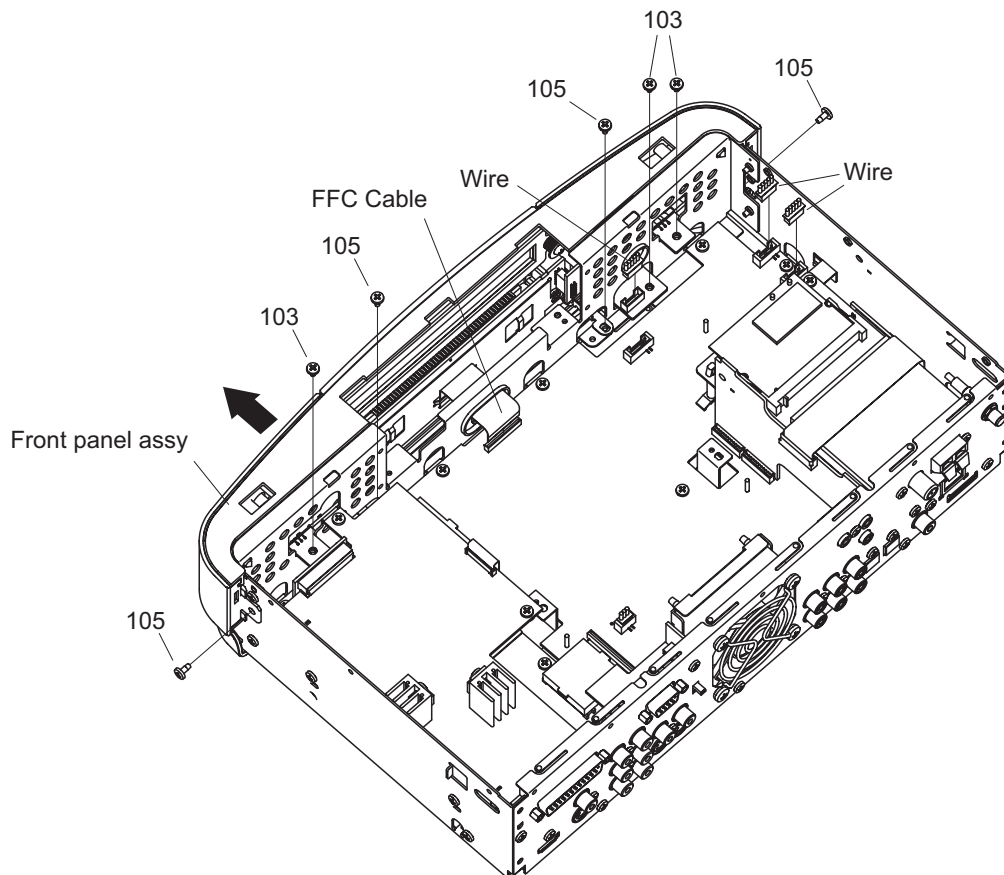
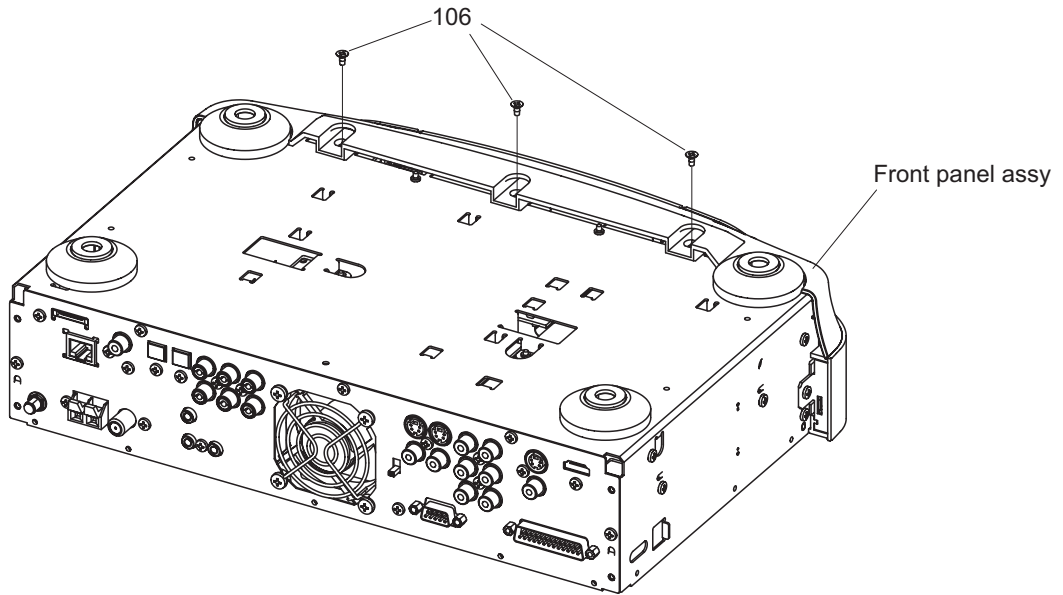



## 5. Rear panel assy

- (1) Remove 10 screws 103 on the top side.
- (2) Remove 5 screws 105 on the rear side and 4 screws 105 on the both sides.
- (3) Detach the Rear panel assy.

## 5. Rear panel assy

- (1) 天面側から 103 のねじ 10 本をはずします。
- (2) 後面側から 105 のねじ 5 本を側面側から 105 のねじ 4 本をはずします。
- (3) Rear panel assy をはずします。

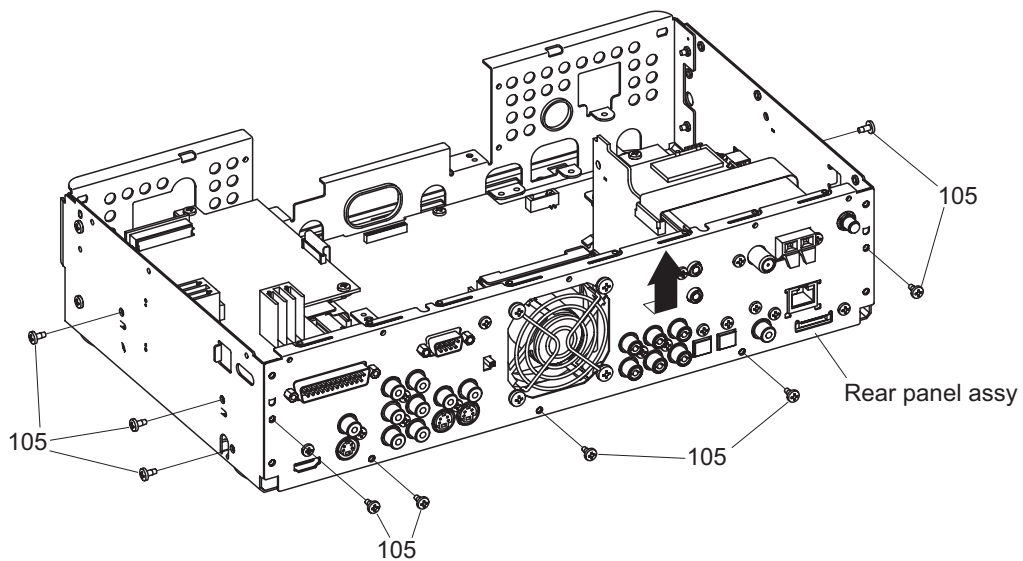
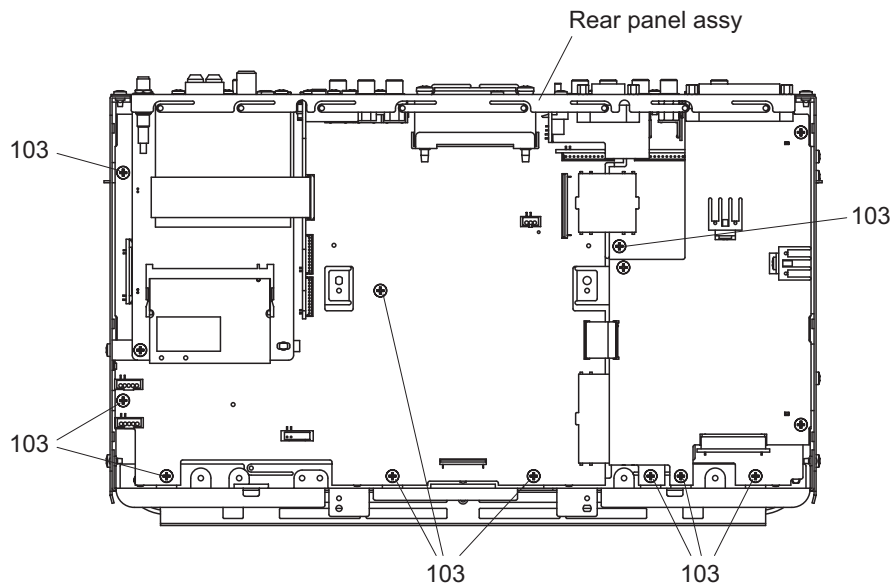



## ● DSW-S302

### 1. Rear panel

- (1) Remove 10 screws 101 on the bottom side.
- (2) Detach the Rear panel.

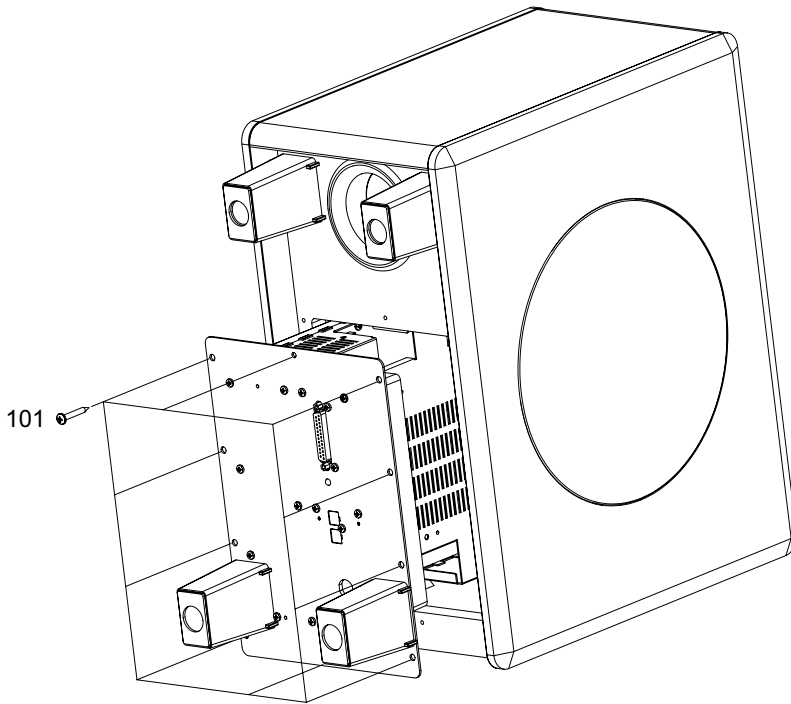

### 2. SHIELD COVER

- (1) Remove 8 screws 103 on the Side.
- (2) Lift the shield cover using a flat-headed screwdriver and remove it. When doing this, be careful not to deform the main bracket's hook.

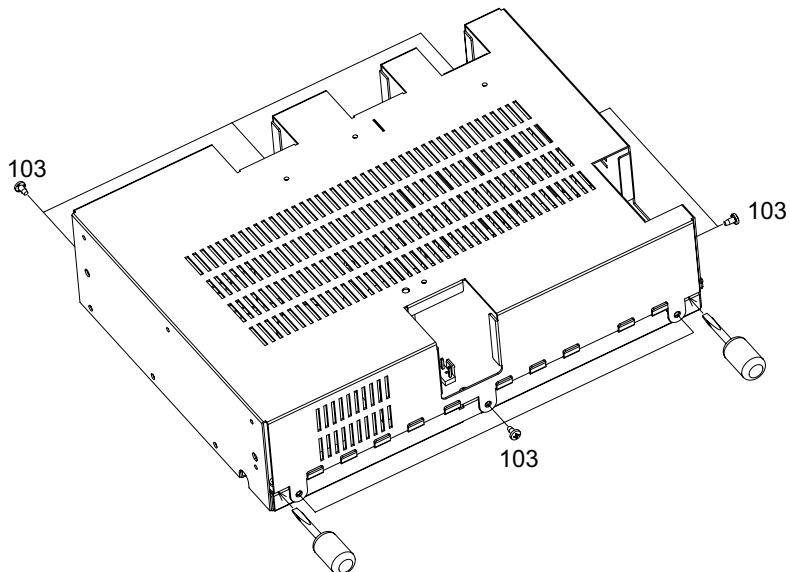

## ● DSW-S302

### 1. Rear panel

- (1) 底面側から 101 のねじ 10 本をはずします。
- (2) Rear panel をはずします。

### 2. SHIELD COVER

- (1) 側面側から 103 のねじ 8 本をはずします。
- (2) マイナスドライバーでシールドカバーを持ち上げては  
ずします。このとき、メインブラケットのつめを变形  
させないように注意してください。

## ATTACHING THE ANTI-SLIP PADS

※ Attach the anti-slip pads as shown on the diagram below.  
Press firmly so they do not peel off subsequently.

### ● Speaker stand

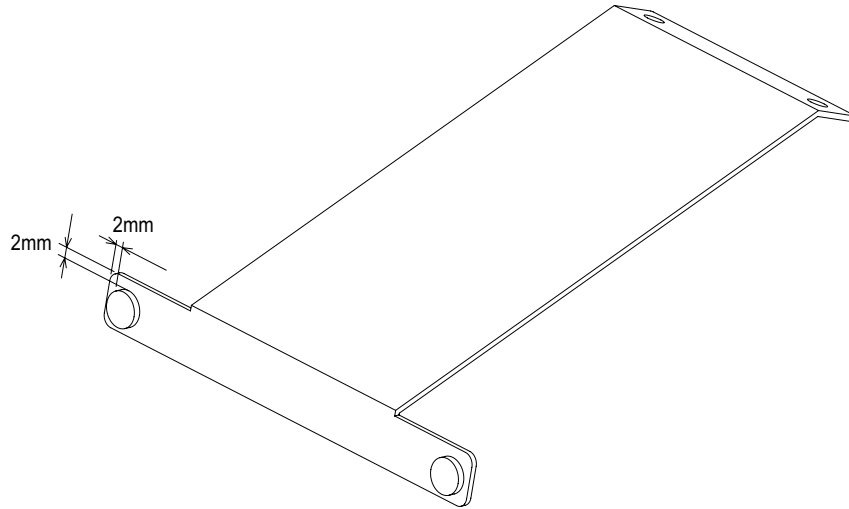

## すべり止めの貼りかた

※ 下図のように、すべり止めを貼り付けます。  
後から剥がれないよう、十分に押し付けてください。

### ● スピーカースタンド

### ● Wall bracket

### ● 壁掛けブラケット

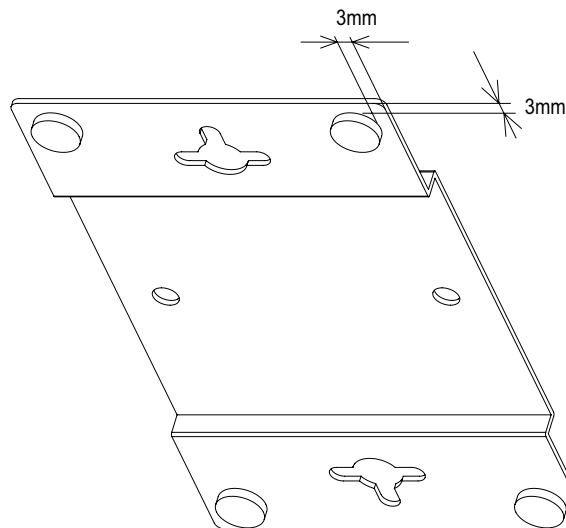

## DIAGNOSTICS OF OPTICAL PICKUP AND REPLACING TRAVERSE UNIT

Make failure diagnostics of the Optical Pickup as follows.  
 If the laser drive current (Iop) becomes more than 1.5 times of the initial value, the Optical Pickup should be replaced.  
 The laser drive current initial value is checked by "Iop checked Method" of next page.  
 In case of replacing the Pickup, change the whole part of the Traverse Unit.  
 No mechanical adjustment is necessary after the replacement.

## 光ピックアップの故障診断とトラバースユニットの交換

次の順序で故障診断を行ってください。  
 レーザー駆動電流 Iop 値が初期値の 1.5 倍以上になっている場合は光ピックアップ交換の目安となります。  
 レーザー駆動電流初期値は、次ページ "Iop 値の確認方法" で確認できます。  
 ピックアップ交換の場合は、トラバースユニット単位での交換となります。メカの調整は不要です。

レーザー駆動電流初期値：

Laser drive current initial value:

DVD:

FL Display (The display part of 13 digits)												
1	2	3	4	5	6	7	8	9	10	11	12	13
T	2	2	—	m	m	m	m	—	n	n	n	n

CD:

FL Display (The display part of 13 digits)												
1	2	3	4	5	6	7	8	9	10	11	12	13
T	2	1	—	m	m	m	m	—	n	n	n	n

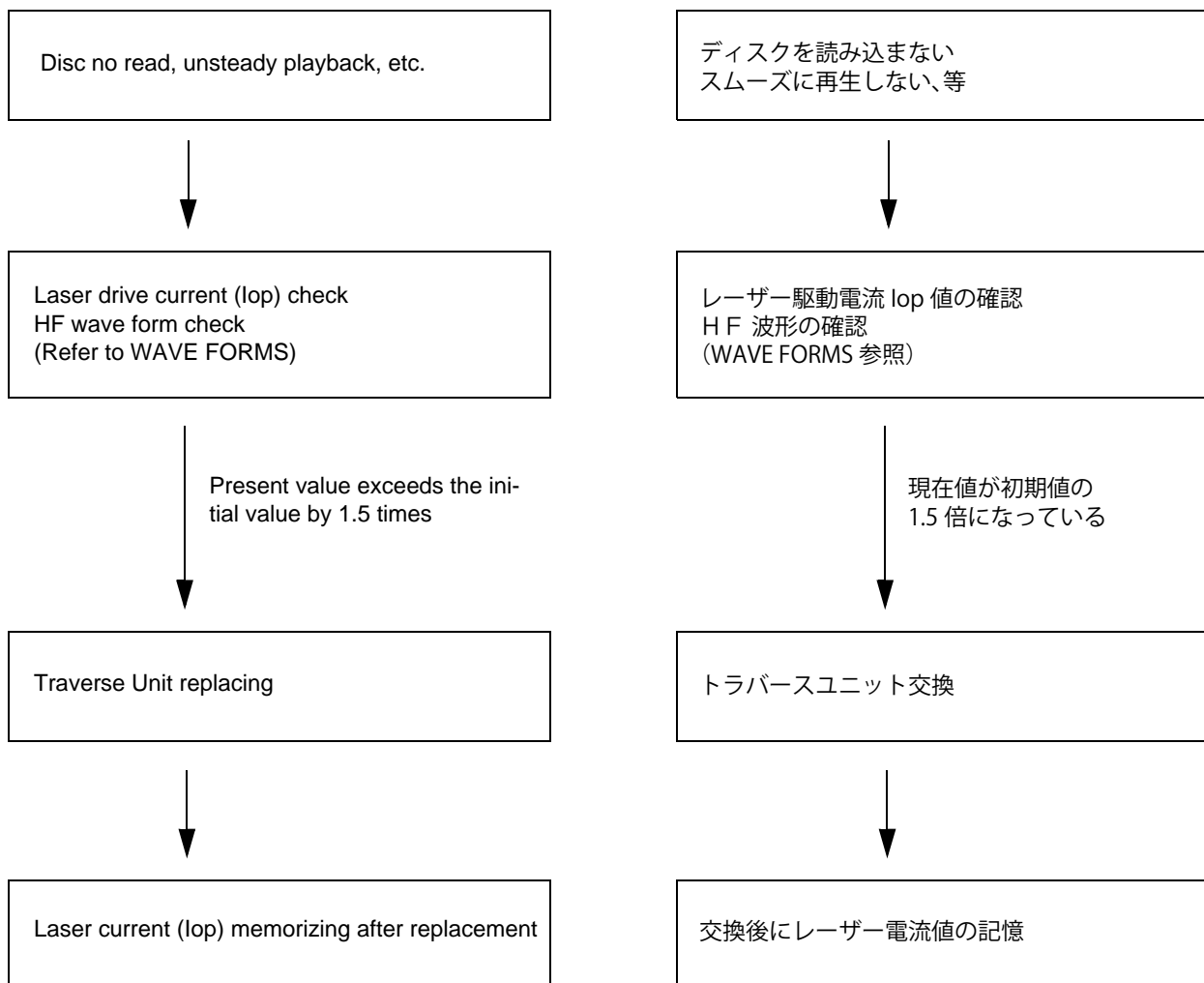

## 1. Iop checked Method

Select the laser ON/OFF (CD/DVD) mode of the test mode, and check the Iop value of DVD laser or CD laser.  
(See page 21 for test mode.)

FL Display (The display part of 13 digits)												
1	2	3	4	5	6	7	8	9	10	11	12	13
T	2		L	a	s	e	r	O	n	O	f	f

### 1.1. DVD laser current check

- Press the SKIP ◀◀ or ▶▶ button to display the laser current value, and then select T22.
- Press the PLAY button and check the current value of Iop (nnnn).  
(Use the disc TDV-520) ⚠

FL Display (The display part of 13 digits)												
1	2	3	4	5	6	7	8	9	10	11	12	13
T	2	2	—	m	m	m	m	—	n	n	n	n

( — : Off, DVD laser, Initial value: mm.mm [mA],  
Current value: nn.nn [mA])

### 1.2. CD Laser current check

- Press the ◀◀ or ▶▶ button to display the laser current value, and then select T21.
- Press the PLAY button and check the current value of Iop (nnnn).  
(Use the disc TCD-784) ⚠

FL Display (The display part of 13 digits)												
1	2	3	4	5	6	7	8	9	10	11	12	13
T	2	1	—	m	m	m	m	—	n	n	n	n

( — : Off, CD laser, Initial value: mm.mm [mA],  
Current value: nn.nn [mA])

## 2. Note for Handling the Laser Pick-Up

The protection for the damage of laser diode.

If you want to change the optical device unit from any other units, you must keep the following.

- It should be done at the desk already took measures the static electricity in care of removing the OPU's (Optical device unit) connector cable.
- Workers should be put on the "Earth Band".
- It should be done to add the solder to the short land to prevent the broken Laser diode before removing the 24P FFC cable.
- Don't touch OPU's connector parts carelessly.

## 3. Replacement of the Laser Pick-up (Traverse Unit)

Check the Iop (Laser drive current)

If the present Iop (current) value exceeds +150% of the initial value, replace the Traverse unit (Laser Pick-up) with a new one.

## 1. Iop 値の確認方法

レーザー駆動電流を確認する場合は、テストモードのレーザー ON/OFF (CD/DVD) モードを選択して、DVD レーザーまたは CD レーザーの Iop 値を確認します。  
(詳細は 21 ページ、テストモード参照)

FL 管の表示 (13 桁の表示部)												
1	2	3	4	5	6	7	8	9	10	11	12	13
T	2		L	a	s	e	r	O	n	O	f	f

### 1.1. DVD レーザー電流確認

- レーザー電流値を表示する場合は、◀◀ ボタンまたは ▶▶ ボタンを押し、T22 を選択します。
- PLAY ボタンを押し、現在の Iop 値 (nnnn) を確認します。  
(Disc は TDV-520 を使用) ⚠

FL 管の表示 (13 桁の表示部)												
1	2	3	4	5	6	7	8	9	10	11	12	13
T	2	2	—	m	m	m	m	—	n	n	n	n

( — : 消灯、DVD レーザー、初期値: mm.mm [mA],  
現在値: nn.nn [mA])

### 1.2. CD レーザー電流確認

- レーザー電流値を表示する場合は、◀◀ ボタンまたは ▶▶ ボタンを押し、T21 を選択します。
- PLAY ボタンを押し、現在の Iop 値 (nnnn) を確認します。  
(Disc は TCD-784 を使用) ⚠

FL 管の表示 (13 桁の表示部)												
1	2	3	4	5	6	7	8	9	10	11	12	13
T	2	1	—	m	m	m	m	—	n	n	n	n

( — : 消灯、CD レーザー、初期値: mm.mm [mA],  
現在値: nn.nn [mA])

## 2. レーザーピックアップの取扱注意

レーザーダイオードの破壊防止。

光素子ユニットを交換するときは、以下を遵守してください。

- 光素子ユニットの接続ケーブルをはずすときは、静電対策を行ったデスク上で作業してください。
- 作業者は、リストストラップを使用してください。
- レーザーダイオードの破壊防止のため、24P FFC ケーブルをはずす前にランドを半田付けショートしてください。
- 光素子ユニットのコネクタ部に触れないでください。

## 3. レーザーピックアップ (トラバースユニット) の交換

Iop (レーザー駆動電流) をチェックします。

現在の Iop 値が初期値の 150% を越えている場合、トラバースユニット (レーザーピックアップ) を交換してください。

#### 4. Rewriting the default value of the laser current

To rewrite the default value of the laser current, press the ► button for at least 5 seconds while the CD or DVD laser current is displayed, then press the ◀◀ or ▶▶ button to select T23. (For details, see "Iop checked Method" on page 22.)

If the ► button is pressed while T23 is displayed, the current value is displayed at "mmmm" and stored in the EEPROM.

FL Display (The display part of 13 digits)												
1	2	3	4	5	6	7	8	9	10	11	12	13
T	2	3	—	m	m	m	m	—	—	—	—	—

#### 5. Resetting the accumulated laser on time

To clear the accumulated laser on time, press the ► button while the accumulated laser on time is displayed (TB1, TB2 : For details, see "Test Mode" on page 22.) until " \* " appears at the fourth position, then press the ◀◀ or ▶▶ button to select TB3.

If the ► button is pressed while TB3 is displayed, the accumulated laser on time of CD and DVD is cleared.

When TB1 or TB2 is selected with the ◀◀ or ▶▶ button, "nnnnnn" is displayed as 0 so you can check.

FL Display (The display part of 13 digits)												
1	2	3	4	5	6	7	8	9	10	11	12	13
T	B	Y	—	—	—	n	n	n	n	n	n	n

( — : Off, Y : 1: CD, 2: DVD, nnnnnn: Hour [h])

#### 4. レーザー電流初期値の書き換え方法

レーザー電流の初期値を書き換えるには、CD または DVD レーザー電流が表示されている時に ► ボタンを5秒以上押し、次に◀◀ボタンまたは▶▶ボタンを押して T23 を選択します。(詳細は 22 ページ、Iop 値の確認方法参照)

T23 表示時に ► ボタンを押すと、mmmm 部に現在値を表示し、EEPROM に保存します。

FL 管の表示 (13 桁の表示部)												
1	2	3	4	5	6	7	8	9	10	11	12	13
T	2	3	—	m	m	m	m	—	—	—	—	—

#### 5. レーザー ON 累積時間のリセット方法

レーザーON 累積時間をクリアするには、レーザーON 累積時間表示 (TB1, TB2) の時 (詳細は 22 ページ、テストモード参照) に ► ボタンを 4 桁目に ' \* ' が表示されるまで押し、◀◀ボタンまたは▶▶ボタンを押して TB3 を表示させます。

TB3 表示時に ► ボタンを押すと、CD 及び DVD レーザーON 累積時間をクリアします。

◀◀ボタンまたは▶▶ボタンで TB1 または TB2 を選択すると、nnnnnn 部が 0 表示となり確認できません。

FL 管の表示 (13 桁の表示部)												
1	2	3	4	5	6	7	8	9	10	11	12	13
T	B	Y	—	—	—	n	n	n	n	n	n	n

( — : 消灯, Y : 1: CD, 2: DVD, nnnnnn : 時間 [h])

### HOW TO REPLACE TRAVERSE UNIT

**Caution:** The optical pickup can be damaged easily by static electricity charged on human body. Take necessary anti-static measures when repairing around the optical pickup.

#### 1. Guide Clamp Bracket disassembly

- (1) Remove 2 screws.
- (2) Remove Guide Clamp Bracket to arrow direction.

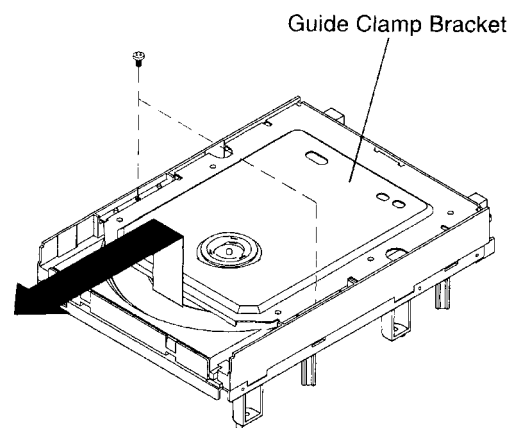

#### 2. Tray disassembly

- (1) Remove to arrow direction.
- (2) Solder the short-circuit (see in the frame).

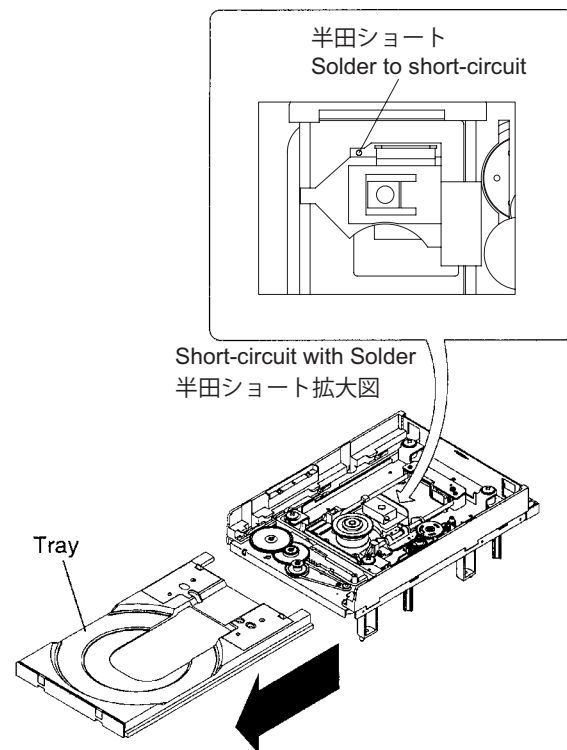

### トラバースユニットの交換方法

注意：光ピックアップは、人体に帯電した静電気等で静電破壊することがあります。光ピックアップ周辺を修理する際は、必要な静電対策を行ってください。

#### 1. ガイドクランプブラケットのはずしかた

- (1) ねじ2本をはずします。
- (2) ガイドクランプブラケットを矢印方向にとりはずします。

#### 2. トレイのはずしかた

- (1) 矢印方向にとりはずします。
- (2) 半田付けショートを行います。(枠内図参照)

### 3. Traverse Unit disassembly

- (1) Remove 24P FFC, 15P FFC and 5P PH WIRE connecting with from the Main P.W.B.
- (2) Remove 4 screws fixing Damper.
- (3) Remove Traverse Unit to arrow direction.

### 3. トラバースユニットのはずしかた

- (1) メイン基板に接続している 24P FFC、15P FFC、5P PH ワイヤをはずします。
- (2) ダンパーを固定しているねじ4本をはずします。
- (3) トラバースユニットを矢印方向にとりはずします。

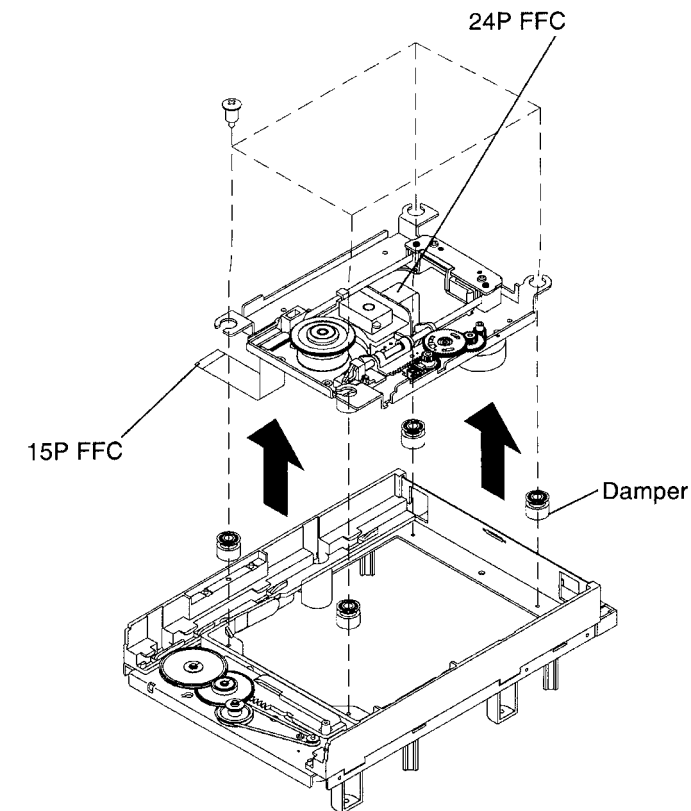

#### Note for disassembly Traverse Unit

- (1) When assembling, reverse the order of the above.
- (2) When inserting Tray, confirm boss on Slide Cam set to ditch of the Tray (Compare with below drawing).

#### トラバースユニット分解の注意

- (1) 組み立てるときは、上記の逆の順序で行ってください。
- (2) トレイ組込み時、スライドカムボスがトレイの溝に合っているか確認してください。(下図参照)

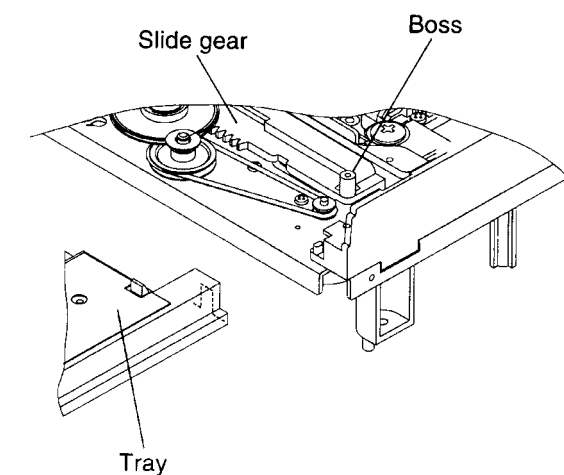

## SERVICE MODE

### 1. Aging Mode

#### 1.1. preparation

- (1) Equipment used: Any one of DVD Karaoke Disc (containing more than 10 titles).  
(ex : Heat run disc TDV-HR01)
- (2) Unit setting : No spec other than the following procedure.

#### 1.2. procedure

※ Perform aging of the DVD.

- (1) Pressing the **■** and **▶** buttons simultaneously, plug the AC cord into a power outlet. This sets the aging mode.

- Once the aging mode is set, press the FUNCTION button to switch the mode.  
(After the display is put out at the switch, it selects.)
  - (a) To select the normal aging mode ... Start from (2)
  - (b) To select the error rate display mode ... Start from (8)

- (2) Press the **▶** button and play all the tracks recorded on the disc.
- (3) Both the "▶" and "■" indicators light on the fluorescent display tube.
- (4) When the **▶** button is pressed once with the tray open, titles 1 and 10 recorded on the disc are played.
- (5) The "▶" indicator flashes and the "■" indicator lights on the fluorescent display tube.
- (6) Once playback is completed, open and close the tray and repeat the operation in step (3) or (4).
- (7) If there is an error while in the aging mode, the error is displayed and the stop mode is set with the status at that time.

NOTE) • The FUNCTION button on the main unit and the FUNCTION selector button on the remote control unit will not work during the aging mode.  
• The ON/STANDBY buttons on the main unit and the remote control unit will not work during the aging mode.  
(If the set's power is turned off, the DVD stops and the aging mode is canceled.)

No.	Error contents	FL display																																							
1	Bad Disc	<table border="1"> <thead> <tr> <th colspan="13">FL Display (The display part of 13 digits)</th> </tr> <tr> <th>1</th><th>2</th><th>3</th><th>4</th><th>5</th><th>6</th><th>7</th><th>8</th><th>9</th><th>10</th><th>11</th><th>12</th><th>13</th> </tr> </thead> <tbody> <tr> <td></td><td>E</td><td>7</td><td></td><td></td><td>X</td><td>X</td><td></td><td>X</td><td>X</td><td></td><td>X</td><td>X</td> </tr> </tbody> </table>	FL Display (The display part of 13 digits)													1	2	3	4	5	6	7	8	9	10	11	12	13		E	7			X	X		X	X		X	X
FL Display (The display part of 13 digits)																																									
1	2		3	4	5	6	7	8	9	10	11	12	13																												
	E		7			X	X		X	X		X	X																												
2	Focus Error																																								
3	Read Error																																								
4	Tracking Error																																								
5	Tray Error																																								
6	Navigation Pack Read Error																																								
7	Communication Error																																								

## サービスモードについて

### 1. エージングモード

#### 1.1. 準備

- (1) 使用機器：DVD カラオケディスク (10 タイトル以上のもの)  
(例：ヒートランディスク TDV-HR01)
- (2) 本体設定：下記設定以外規定無。

#### 1.2. 手順

※ DVD のエージングをおこなう。

- (1) 本体の **■** ボタンと **▶** ボタンを同時に押しながら AC コードをコンセントへ接続すると、エージングモードが設定される。

- エージングモード設定後、FUNCTION ボタンを押して、モードを切り替える。  
(切り替え時に表示を出してから選択する。)
- (a) 通常のエージングモードを選択・・・(2) から開始
- (b) エラーレート表示モードを選択・・・(8) から開始

- (2) **▶** ボタンを押し、ディスクに収録されている全ての曲を再生する。
- (3) FL 管の "▶" インジケータと "■" インジケータが両方とも点灯する。
- (4) トレーを開いた状態で **▶** ボタンを 1 回押して、ディスクに収録されているタイトル 1 とタイトル 10 を再生する。
- (5) FL 管の "▶" インジケータが点滅し、"■" インジケータが点灯する。
- (6) 再生終了後、トレーを開閉させ (3) または (4) の動作をする。
- (7) エージングモード中にエラーが発生すると、エラーを表示し、その時の状態で停止する。  
注) • エージングモード中は、本体の FUNCTION ボタンおよび、リモコンの FUNCTION 切替ボタンは動作しない。  
• エージングモード中は本体およびリモコンの ON/STANDBY ボタンを動作しない。  
(セットの電源を OFF にすると DVD が停止し、エージングモードが解除される。)

No.	エラー内容	FL 管表示																																							
1	不良ディスク	<table border="1"> <thead> <tr> <th colspan="13">FL 管の表示 (13 桁の表示部)</th> </tr> <tr> <th>1</th><th>2</th><th>3</th><th>4</th><th>5</th><th>6</th><th>7</th><th>8</th><th>9</th><th>10</th><th>11</th><th>12</th><th>13</th> </tr> </thead> <tbody> <tr> <td></td><td>E</td><td>7</td><td></td><td></td><td>X</td><td>X</td><td></td><td>X</td><td>X</td><td></td><td>X</td><td>X</td> </tr> </tbody> </table>	FL 管の表示 (13 桁の表示部)													1	2	3	4	5	6	7	8	9	10	11	12	13		E	7			X	X		X	X		X	X
FL 管の表示 (13 桁の表示部)																																									
1	2		3	4	5	6	7	8	9	10	11	12	13																												
	E		7			X	X		X	X		X	X																												
2	フォーカスエラー																																								
3	リードエラー																																								
4	トラッキングエラー																																								
5	トレイエラー																																								
6	ナビゲーションパックエラー																																								
7	コマンド通信エラー																																								



## 2. Initial Setting Mode

### 2.1. Preparation

- (1) Equipment used: None
- (2) Unit setting: No spec other than the following procedure.

### 2.2. Procedure

#### ● SYSTEM

※ This initializes the data for the function, volume, DVD mechanism, etc.

- (1) When the ON/STANDBY button is pressed to turn the set on while pressing the main unit's FUNCTION and **◀◀** buttons simultaneously, the initialization mode is set.
- (2) The standby indicator lights yellow and "INITIALIZE" is displayed on the fluorescent display tube.  
(If you set the button free, the LED indicator lights blue.) 
- (3) Once the entire initialization procedure has been completed, the set is in the normal mode with the power turned on.

#### ● DVD

※ This initializes the data for the DVD mechanism.

- (1) With the power on, set the function to DVD, and in the playback stopped mode, press the **■** and **◀◀** buttons simultaneously for at least 2 seconds to set the DVD initialization mode.
- (2) "INITIALIZE" is displayed on the fluorescent display tube about 0.5 seconds. 

## 3. μcom Firm Check Mode

### 3.1. Preparation

- (1) Equipment used: None
- (2) Unit setting: No spec other than the following procedure.

### 3.2. Procedure

※ Use this to display the version information, etc.

- (1) When the STANDBY mode, the FUNCTION, the **▶▶|** and the ON/STANDBY button are simultaneously pressed. Afterwards, when the power supply of the set is turned on pressing the ON/STANDBY button, the system check mode is set.
- (2) Press the STATUS button on the remote control unit to display the following information, in this order: System microprocessor version → Date of system microprocessor version updating → ESS version → Date of ESS version updating → drive microprocessor version of DVD mechanism → M850 version → Region code.
- (3) Unplug AC cord to clear this mode.

NOTE) The DVD mechanism driver version and ESS version are not displayed unless the function is once set to DVD.

## 2. イニシャルモード

### 2.1. 準備

- (1) 使用機器：無
- (2) 本体設定：下記手順以外規定無。

### 2.2. 手順

#### ● システム

※ ファンクション、VOL 等および DVD メカのバックアップデータの初期化をおこなう。

- (1) 本体 FUNCTION ボタンと **◀◀** ボタンを同時に押しながら、ON/STANDY ボタンを押してセットの電源を入れるとイニシャルモードが設定される。
- (2) スタンバイ LED が黄色に点灯し、FL 管に "INITIALIZE" が表示される。  
(ボタンを離すと LED は青色点灯になる) 
- (3) 全ての初期化完了後、通常モードの電源 ON の状態になる。

#### ● DVD

※ DVD のみのバックアップデータの初期化をおこなう。

- (1) 電源 ON 時にファンクションを DVD にし再生停止状態で、**■** ボタンと **◀◀** ボタンを 2 秒以上同時に押し続けると、DVD 初期化モードが設定される。
- (2) FL 管に "INITIALIZE" が 0.5 秒程表示される。 

## 3. マイコンファームチェックモード

### 3.1. 準備

- (1) 使用機器：無
- (2) 本体設定：下記手順以外規定無。

### 3.2. 手順

※ バージョン表示等をおこなう。

- (1) STANDBY 時に本体 FUNCTION ボタン、**▶▶|** ボタンと ON/STANDBY ボタンを同時に押す。その後、ON/STANDBY ボタンを押してセットの電源を入れると、システムチェックモードが設定される。
- (2) リモコンの STATUS ボタンを押すと、システムマイコンのバージョン→システムマイコンのバージョンアップ日→ESS のバージョン→ESS のバージョンアップ日→DVD メカのドライブマイコンのバージョン→DM850 のバージョン→リージョンコードの順に表示される。
- (3) AC コードを抜くことにより、システムチェックモードを解除する。

注) DVD メカのドライブバージョン、ESS のバージョンの表示については、一度ファンクションを DVD にしないと表示されない。



## 4. Test mode

### 4.1. Entering the test mode

To enter the test mode, press the **■** and **▶▶▶** buttons simultaneously while in the Aging mode. Not insert the disc.  
 (The Aging mode is entered by pressing the **■** and **▶** buttons simultaneously to turn on the AC power.  
 When the Aging mode is set, the **▶** and **■** indicators light.)

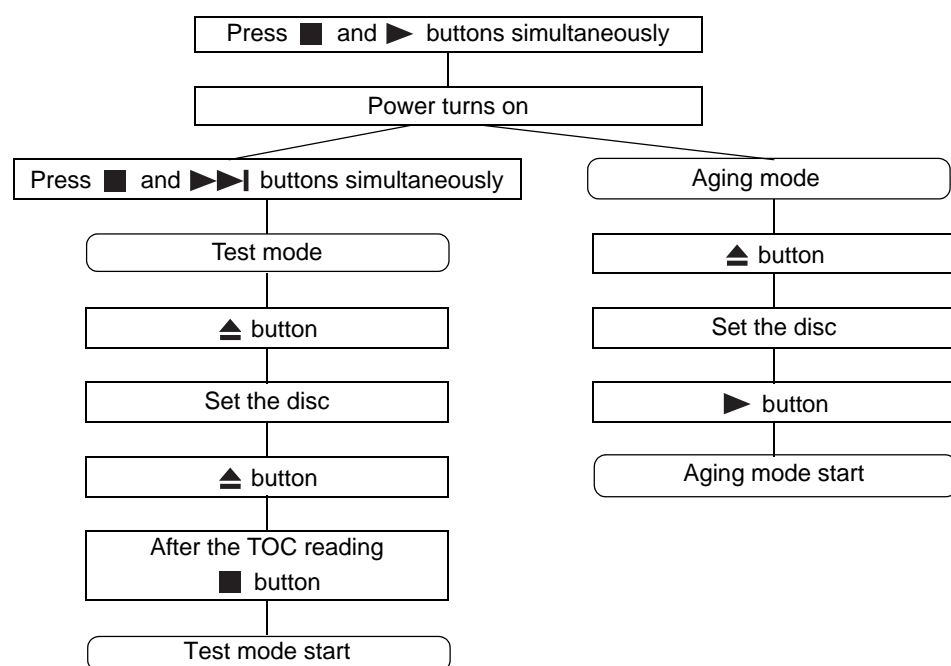

FL tube display when test mode entered

FL Display (The display part of 13 digits)												
1	2	3	4	5	6	7	8	9	10	11	12	13
		T	E	S	T			M	O	D	E	

### 4.2. Selecting the mode

The following modes are available.

- (1) Laser on/off (CD/DVD) mode : T2
- (2) Servo adjustment value display mode : T3
- (3) Trace mode (error rate display) : T7
- (4) Accumulated laser on time : TB

① When the **▶▶▶** button is pressed after entering the test mode, the display switches in the order: T2, T3, T7, TB, T2...

FL Display (The display part of 13 digits)												
1	2	3	4	5	6	7	8	9	10	11	12	13
T	2			L	a	s	e	r	O	n	O	f

FL Display (The display part of 13 digits)												
1	2	3	4	5	6	7	8	9	10	11	12	13
T	3			S	e	r	v	o		A	d	j

FL Display (The display part of 13 digits)												
1	2	3	4	5	6	7	8	9	10	11	12	13
T	7			T	r	a	c	e		M	o	d

FL Display (The display part of 13 digits)												
1	2	3	4	5	6	7	8	9	10	11	12	13
T	B			L	a	s	e	r	O	n	T	i

## 4. テストモード

### 4.1. テストモードの設定

テストモードの設定はエージングモード時に **■** ボタンと **▶▶▶** ボタンを同時に押すことでおこなう。ディスクは挿入していないこと。  
 (エージングモードの設定は **■** ボタンと **▶** ボタンを同時に押しながら、ACコードをコンセントへ接続し、セットの電源を入れる。エージングモードになるとFL管の“▶”インジケータと“■”インジケータが点灯する。)

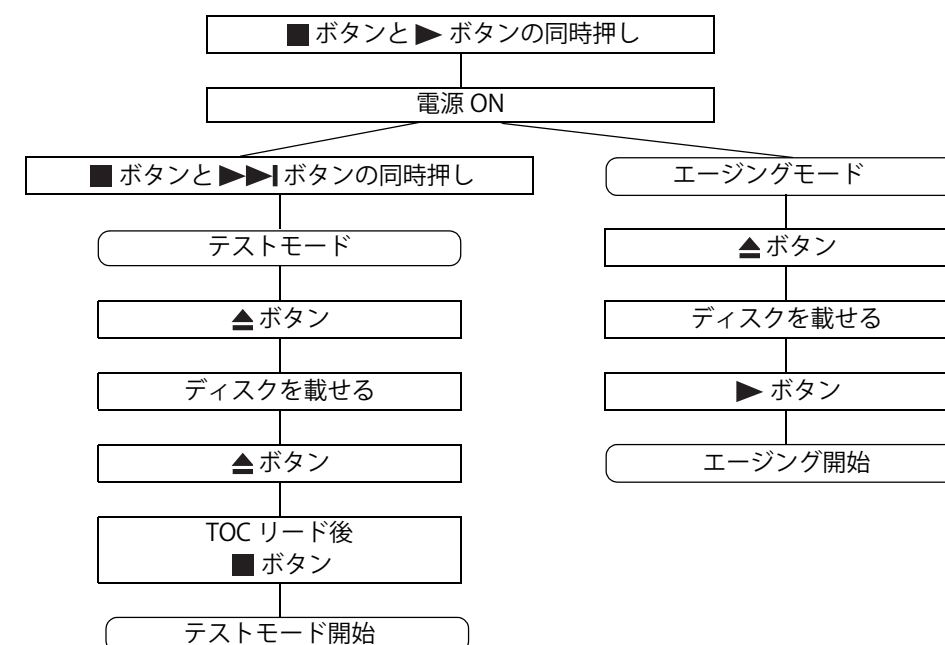

テストモード設定時のFL管表示

FL 管の表示 (13 桁の表示部)												
1	2	3	4	5	6	7	8	9	10	11	12	13
		T	E	S	T			M	O	D	E	

### 4.2. モードの選択

モードには、次のモードがある。

- (1) レーザー ON/OFF(CD/DVD) モード : T2
- (2) サーボ調整値表示モード : T3
- (3) トレースモード (エラーレート表示) : T7
- (4) レーザー ON 累積時間 : TB

①テストモード中に **▶▶▶** ボタンを押すと、T2,T3,T7,TB,T2...の順に表示される。

FL 管の表示 (13 桁の表示部)												
1	2	3	4	5	6	7	8	9	10	11	12	13
T	2			L	a	s	e	r	O	n	O	f

FL 管の表示 (13 桁の表示部)												
1	2	3	4	5	6	7	8	9	10	11	12	13
T	3			S	e	r	v	o		A	d	j

FL 管の表示 (13 桁の表示部)												
1	2	3	4	5	6	7	8	9	10	11	12	13
T	7			T	r	a	c	e		M	o	d

FL 管の表示 (13 桁の表示部)												
1	2	3	4	5	6	7	8	9	10	11	12	13
T	B			L	a	s	e	r	O	n	T	i

### 4.3. Setting the mode

With the mode selected, press the ► button to set that mode.

- ① In the laser on/off (CD/DVD) mode, laser on/off control is executed and the laser current is displayed.

Press the ◀◀◀ or ▶▶▶ button to switch the CD/DVD (T21, T22, T21. .).

To save the current laser current value, press and hold in the ► button for at least 5 seconds to turn off the "mmmm" section of the display, then press the ◀◀◀ or ▶▶▶ button and select T23. When the ► button is pressed while T23 is displayed, the data is displayed in the "mmmm" section.

For the CD laser

FL Display (The display part of 13 digits)												
1	2	3	4	5	6	7	8	9	10	11	12	13
T	2	1	—	m	m	m	m	—	n	n	n	n

(— : Off, CD laser, Stored data: mm.mm [mA], Current value: nn.nn [mA])

For the DVD laser

FL Display (The display part of 13 digits)												
1	2	3	4	5	6	7	8	9	10	11	12	13
T	2	2	—	m	m	m	m	—	n	n	n	n

(— : Off, DVD laser, Stored data: mm.mm [mA], Current value: nn.nn [mA])

- ② In the servo adjustment value display mode (See "Table 1 - Servo adjustment value display mode details")

FL Display (The display part of 13 digits)												
1	2	3	4	5	6	7	8	9	10	11	12	13
T	X	X	—	—	—	—	—	—	n	n	n	n

(XX : Selection mode, n : Adjustment value (HEX))

- ③ In the trace mode (error rate display), select the trace of the innermost circumference of 1 layer.

FL Display (The display part of 13 digits)												
1	2	3	4	5	6	7	8	9	10	11	12	13
T	7	1	F	F	F	F	F	F	F	F	F	F

(F : When address and error rate not set, F is displayed.)

- ④ Displaying the accumulated laser on time (stored in the EEPROM)

FL Display (The display part of 13 digits)												
1	2	3	4	5	6	7	8	9	10	11	12	13
T	B	Y	—	—	—	n	n	n	n	n	n	n

(Y : 1:CD, 2:DVD, nnnnn: Time [h])

※ Fractions of hours are counted up one hour on the display.

### 4.3. モードの確定

モードを選択してある状態で ► ボタンを押すとモードを確定する。

- ①レーザー ON/OFF(CD/DVD) モードの場合、レーザーの ON/OFF 制御を実行し、レーザー電流を表示する。CD/DVD の切り替えは、◀◀◀ ボタンまたは ▶▶▶ ボタンを押す (T21、T22、T21. .)。  
現在のレーザー電流値を保存する場合、► ボタンを 5 秒以上押し続け、mmmm 部を非表示にし、◀◀◀ ボタンまたは ▶▶▶ ボタンを押して、T23 を選択する。T23 を表示時に ► ボタンを押すと、mmmm 部にデータが表示される。

CD レーザーの場合

FL 管の表示 (13 桁の表示部)												
1	2	3	4	5	6	7	8	9	10	11	12	13
T	2	1	—	m	m	m	m	—	n	n	n	n

(— : 消灯、CD レーザー、保存データ: mm.mm[mA], 現在値: nn.nn[mA])

DVD レーザーの場合

FL 管の表示 (13 桁の表示部)												
1	2	3	4	5	6	7	8	9	10	11	12	13
T	2	2	—	m	m	m	m	—	n	n	n	n

(— : 消灯、DVD レーザー、保存データ: mm.mm[mA], 現在値: nn.nn [mA])

- ②サーボ調整値表示モードの場合 (表 1 サーボ調整値表示モード詳細 参照)

FL 管の表示 (13 桁の表示部)												
1	2	3	4	5	6	7	8	9	10	11	12	13
T	X	X	—	—	—	—	—	—	n	n	n	n

(X X: 選択モード、n: 調整値 (HEX))

- ③トレースモード (エラーレート表示) の場合は、1 層内周のトレースを選択する。

FL 管の表示 (13 桁の表示部)												
1	2	3	4	5	6	7	8	9	10	11	12	13
T	7	1	F	F	F	F	F	F	F	F	F	F

(F: アドレス及びエラーレートは未確定時、F を表示する。)

- ④レーザー ON 累積時間 (EEPROM に記憶) を表示する。

FL 管の表示 (13 桁の表示部)												
1	2	3	4	5	6	7	8	9	10	11	12	13
T	B	Y	—	—	—	n	n	n	n	n	n	n

(Y : 1:CD, 2:DVD, nnnnn: 時間 [h])

※ 1 時間未満は切り上げて表示する。

#### 4.4. Change within the mode

Changes within modes are made by pressing the ◀◀ and ▶▶ buttons while the mode is set.

- ① In the laser on/off (CD/DVD) mode, laser on/off control is executed and the laser current is displayed.

For the CD laser

FL Display (The display part of 13 digits)												
1	2	3	4	5	6	7	8	9	10	11	12	13
T	2	1	—	m	m	m	m	—	n	n	n	n

(— : Off, CD laser, Stored data: mm.mm [mA], Current value: nn.nn [mA])

For the DVD laser

FL Display (The display part of 13 digits)												
1	2	3	4	5	6	7	8	9	10	11	12	13
T	2	2	—	m	m	m	m	—	n	n	n	n

(— : Off, DVD laser, mm.mm [mA], nn.nn [mA])

When there is no saved data (for the DVD laser)

FL Display (The display part of 13 digits)												
1	2	3	4	5	6	7	8	9	10	11	12	13
T	2	2	—	—	—	—	—	—	n	n	n	n

(— : Off, DVD laser, nn.nn [mA])

To store the current value, press the ▶ button for " \* " appears at the fourth position, then press the ◀◀ or ▶▶ button to select T23.

If the ▶ button is pressed while T23 is displayed, the current value is displayed at "mmmm" and stored in the EEPROM.

FL Display (The display part of 13 digits)												
1	2	3	4	5	6	7	8	9	10	11	12	13
T	2	3	—	m	m	m	m	—	n	n	n	n

(— : Off, DVD laser, nn.nn [mA])

If the current value is over 100 mA, the 4th and 9th digit sections are used.

- ② In the servo adjustment value display mode (See "Table 1 - Servo adjustment value display mode details")

FL Display (The display part of 13 digits)												
1	2	3	4	5	6	7	8	9	10	11	12	13
T	X	X	—	—	n	n	n	n	n	n	n	n

(XX : Selection mode, n: Adjustment value (HEX))

For the adjustment values, 0's are added in front of the effective number of bytes.

(Ex.: If the value is 0x123 for 4-byte data, "00 00 01 23" is displayed.)

- ⑤ In the trace mode (error rate display) (See "Table 2 - Trace mode details")

FL Display (The display part of 13 digits)												
1	2	3	4	5	6	7	8	9	10	11	12	13
T	Y	Y	F	F	F	F	F	F	F	F	F	F

(YY : Selection mode [71 to 94], F: When address and error rate not set, F is displayed.)

- ⑥ In the accumulated laser on time display

FL Display (The display part of 13 digits)												
1	2	3	4	5	6	7	8	9	10	11	12	13
T	B	Y	—	—	—	n	n	n	n	n	n	n

(Y : 1: CD, 2: DVD, nnnnnn: Time [h]) ※ If the current value is over 100 mA, the 4th and 9th digit sections are used.

To clear the accumulated laser on time, press the ▶ button while the accumulated laser on time is displayed (TB1, TB2) until " \* " appears at the fourth position, then press the ◀◀ or ▶▶ button to select TB3.

If the PLAY button is pressed while TB3 is displayed, the accumulated laser on time of CD and DVD is cleared.

When TB1 or TB2 is selected with the ◀◀ or ▶▶ button, "nnnnnn" is displayed as 0 so you can check.

#### 4.4. モード内での変更

モードを確定してある状態で◀◀ボタンまたは▶▶ボタンを押すとモード内での変更をおこなう。

- ①レーザー ON/OFF(CD/DVD) モードの場合、レーザーの ON/OFF 制御を実行し、レーザー電流を表示する。

CD レーザーの場合

FL 管の表示 (13 桁の表示部)												
1	2	3	4	5	6	7	8	9	10	11	12	13
T	2	1	—	m	m	m	m	—	n	n	n	n

(— : 消灯、CD レーザー、保存データ: mm.mm[mA], 現在値: nn.nn[mA])

DVD レーザーの場合

FL 管の表示 (13 桁の表示部)												
1	2	3	4	5	6	7	8	9	10	11	12	13
T	2	2	—	m	m	m	m	—	n	n	n	n

(— : 消灯、DVD レーザー、mm.mm[mA], nn.nn[mA])

保存データなしの場合 (DVD レーザーの場合)

FL 管の表示 (13 桁の表示部)												
1	2	3	4	5	6	7	8	9	10	11	12	13
T	2	2	—	—	—	—	—	—	n	n	n	n

(— : 消灯、DVD レーザー、nn.nn[mA])

現在値を保存するには、▶ ボタンを 4 桁目に "\*" が表示されるまで押し、次に◀◀ボタンまたは▶▶ボタンを押して T23 を選択する。T23 表示時に、▶ ボタンを押すと、mmmm 部に現在値を表示し、EEPROM に保存される。

FL 管の表示 (13 桁の表示部)												
1	2	3	4	5	6	7	8	9	10	11	12	13
T	2	3	—	m	m	m	m	—	—	—	—	—

(— : 消灯、DVD レーザー、mm.mm[mA])

電流値が 100mA 以上の場合は、4 桁、9 桁部分を使用。

- ②サーボ調整値表示モードの場合 (表 1 サーボ調整値表示モード詳細 参照)

FL 管の表示 (13 桁の表示部)												
1	2	3	4	5	6	7	8	9	10	11	12	13
T	X	X	—	—	n	n	n	n	n	n	n	n

(XX : 選択モード, n: 調整値 (HEX))

調整値は、有効バイト数分先頭に 0 をつける。

(例: 4 バイトデータで値が 0x123 の場合は "00 00 01 23" )

- ③トレースモード (エラーレート表示) の場合 (表 2 トレースモード詳細 参照)

FL 管の表示 (13 桁の表示部)												
1	2	3	4	5	6	7	8	9	10	11	12	13
T	Y	Y	F	F	F	F	F	F	F	F	F	F

(YY : 選択モード [71 ~ 94], F: アドレス及びエラーレートは未確定時、F を表示する。)

- ⑥レーザー ON 累積時間を表示場合

FL 管の表示 (13 桁の表示部)												
1	2	3	4	5	6	7	8	9	10	11	12	13
T	B	Y	—	—	—	n	n	n	n	n	n	n

(Y : 1: CD, 2: DVD, nnnnnn: 時間 [h]) ※ 1 時間未満は切り上げて表示する。

レーザー ON 累積時間をクリアする場合、レーザー ON 累積時間表示時 (TB1, TB2) のとき、▶ ボタンを 4 桁目に "\*" が表示されるまで押し、◀◀ボタンまたは▶▶ボタンを押して、TB3 を表示させる。TB3 表示時に▶ ボタンを押すと CD および DVD レーザー ON 累積時間をクリアする。◀◀ボタンまたは▶▶ボタンを押して、TB1 または TB2 を選択すると、nnnnnn 部が 0 表示になり確認できる。

#### 4.5. Execution of trace mode (error rate display) (See "Table 2 - Trace mode details")

Trace will be performed if the ► button is pushed after choosing operation.

FL Display (The display part of 13 digits)												
1	2	3	4	5	6	7	8	9	10	11	12	13
T	Y	Y	m	m	m	m	m	m	l	l	l	l

(YY : selection mode [71 to 94], m : address [PBA][HEX], l : error rate [COUNT/SEC] [HEX])

Note) CD : Error rate of 75 frames is displayed (1 second).

DVD : Error rate of 8ECC block is displayed.

The mode chosen when selection mode was changed into the trace execution and the ► button was pushed is performed from the beginning.

When the ► button is pushed without changing selection mode, the mode under selection is performed from the beginning. (If the ► button is pushed, the address corresponding to the chosen mode will be searched again.)

The pause mode is set after tracing is completed.

#### 4.6. Other operations

- ① When the ■ button is pressed, the mode returns to the previously selected mode.

#### 4.5. トレースモード (エラーレート表示) の実行 (表2 トレースモード詳細 参照)

動作を選択した後、► ボタンを押すとトレースを実行する。

FL 管の表示 (13 桁の表示部)												
1	2	3	4	5	6	7	8	9	10	11	12	13
T	Y	Y	m	m	m	m	m	m	l	l	l	l

(YY: 選択モード [71 ~ 94]、m: アドレス [PBA][HEX]、l: エラーレート [COUNT][DEC])

注) CD : 表示するエラーレートは、75 フレーム分の値 (1 秒)。

DVD : 表示するエラーレートは、8ECC ブロック分の値。

トレース実行中に選択モードを変更し、► ボタンを押すと選択したモードを最初から実行する。

選択モードを変更せずに ► ボタンを押した場合も、選択中のモードを最初から実行する。

(► ボタンを押すと、選択しているモードに対応したアドレスを再度サーチする。)

トレース終了時は、PAUSE 状態になります。

#### 4.6. その他の動作

- ① ■ ボタンを押すと、前の選択モードに戻る。

#### (1) Test mode detailed table

Table 1: Servo adjustment value display mode details

XXX	Name	Size	Meaning	Remarks
T31	fbal0	16bits	CD/DVD L0 layer focus balance adjustment value	FBAL range: 0x8000 < FBAL < 0x7FC0(Center:0x0000)
T32	tbal0	16bits	CD/DVD L0 layer tracking balance adjustment value	TBAL range: 0x0000 < TBAL < 0x003F
T33	fcga0	16bits	CD/DVD L0 layer focus Loop Gain adjustment value	1x for 0x100 [0x200 (2x) set to Typ. (1x for 0x100, 2x for 0x200. Y/0x100 ratio calculation.) Adjustment value 0x200 sets so that gain crossover reaches target.
T34	tkga0	16bits	CD/DVD L0 layer tracking Loop Gain adjustment value	1x for 0x100 [0x200 (2x) set to Typ. (1x for 0x100, 2x for 0x200. Y/0x100 ratio calculation.) Adjustment value 0x202 sets so that gain crossover reaches target.
T35	Fbal1	16bits	DVD L1 layer focus balance adjustment value	FBAL range: 0x8000 < FBAL < 0x7FC0(Center:0x0000)
T36	Tbal1	16bits	DVD L1 layer tracking balance adjustment value	TBAL range: 0x0000 < TBAL < 0x003F
T37	Fcga1	16bits	DVD L1 layer focus Loop Gain adjustment value	1x for 0x100 [0x200 (2x) set to Typ. (1x for 0x100, 2x for 0x200. Y/0x100 ratio calculation.) Adjustment value 0x200 sets so that gain crossover reaches target.
T38	Tkga1	16bits	DVD L1 layer tracking Loop Gain adjustment value	1x for 0x100 [0x200 (2x) set to Typ. (1x for 0x100, 2x for 0x200. Y/0x100 ratio calculation.) Adjustment value 0x202 sets so that gain crossover reaches target.
T39	Asoffs	16bits	AS signal Offset value	Upper 10 bit is valid
T40	Envoffse	16bits	ENV signal Offset adjustment value	Upper 10 bit is valid
T41	Foffse	16bits	FE signal Offset adjustment value	Upper 10 bit is valid
T42	Teoffse	16bits	TE signal Offset adjustment value	Upper 10 bit is valid
T43	RFfc	8bits	RF signal frequency adjustment value	
T44	RFbst	8bits	RF signal Boost adjustment value	Adjustment range : 0x0000 ~ 0x001F 0x0000 : 0dB 0x001F : 14dB
T45	RFgdl	8bits	RF signal low range group delay adjustment value	
T46	RFgdh	8bits	RF signal high range group delay adjustment value	

#### (1) テストモード詳細一覧表

表1 サーボ調整値表示モード詳細

XXX	名称	サイズ	意味	備考
T31	fbal0	16ビット	CD/DVD L0 層フォーカスバランス調整値	FBAL の範囲は 0x8000 < FBAL < 0x7FC0。(センター : 0x0000)
T32	tbal0	16ビット	CD/DVD L0 層トラッキングバランス調整値	TBAL の範囲は 0x0000 < TBAL < 0x003F。
T33	fcga0	16ビット	CD/DVD L0 層フォーカス Loop Gain 調整値	0x100 で 1 倍 [0x200(2 倍) を Typ に設定する] (0x100 で 1 倍、0x200 で 2 倍。Y/0x100 の比率計算) 調整値 0x200 で Gain 交点が目標ターゲットになる様設定している。
T34	tkga0	16ビット	CD/DVD L0 層トラッキング Loop Gain 調整値	0x100 で 1 倍 [0x200(2 倍) を Typ に設定する。] (0x100 で 1 倍、0x200 で 2 倍。Y/0x100 の比率計算) 調整値 0x202 で Gain 交点が目標ターゲットになる様設定している。
T35	Fbal1	16ビット	DVD L1 層フォーカスバランス調整値	FBAL の範囲は 0x8000 < FBAL < 0x7FC0。(センター : 0x0000)
T36	Tbal1	16ビット	DVD L1 層トラッキングバランス調整値	TBAL の範囲は 0x0000 < TBAL < 0x003F。
T37	Fcga1	16ビット	DVD L1 層フォーカス Loop Gain 調整値	0x100 で 1 倍 [0x200(2 倍) を Typ に設定する] (0x100 で 1 倍、0x200 で 2 倍。Y/0x100 の比率計算) 調整値 0x200 で Gain 交点が目標ターゲットになる様設定している。
T38	Tkga1	16ビット	DVD L1 層トラッキング Loop Gain 調整値	0x100 で 1 倍 [0x200(2 倍) を Typ に設定する] (0x100 で 1 倍、0x200 で 2 倍。Y/0x100 の比率計算) 調整値 0x202 で Gain 交点が目標ターゲットになる様設定している。
T39	Asoffs	16ビット	AS 信号の Offset 値	上位 10bit が有効
T40	Envoffse	16ビット	ENV 信号の Offset 調整値	上位 10bit が有効
T41	Foffse	16ビット	FE 信号の Offset 調整値	上位 10bit が有効
T42	Teoffse	16ビット	TE 信号の Offset 調整値	上位 10bit が有効
T43	RFfc	8ビット	RF 信号の周波数調整値	
T44	RFbst	8ビット	RF 信号の Boost 調整値	調整範囲 : 0x0000 ~ 0x001F 0x0000 : 0dB 0x001F : 14dB
T45	RFgdl	8ビット	RF 信号の低域群遅延調整値	
T46	RFgdh	8ビット	RF 信号の高域群遅延調整値	

Table 2: Trace mode details

YY	Contents	Contents supplement
71	A display of PO error detection number of the inner circumference of 1-layer and an address.	It is invalid at the time of CD operation.
72	A display of PO uncorrectable number of the inner circumference of 1-layer and an address.	It is invalid at the time of CD operation.
73	A display of PI error detection number of the inner circumference of 1-layer and an address.	CD : C1 error detection number (x3)
74	A display of PI uncorrectable number of the inner circumference of 1-layer and an address.	It is invalid at the time of CD operation.
75	A display of PO error detection number of the central circumference of 1-layer and an address.	It is invalid at the time of CD operation.
76	A display of PO uncorrectable number of the central circumference of 1-layer and an address.	It is invalid at the time of CD operation.
77	A display of PI error detection number of the central circumference of 1-layer and an address.	CD : C1 error detection number (x3)
78	A display of PI uncorrectable number of the central circumference of 1-layer and an address.	It is invalid at the time of CD operation.
79	A display of PO error detection number of the outer circumference of 1-layer and an address.	It is invalid at the time of CD operation.
80	A display of PO uncorrectable number of the outer circumference of 1-layer and an address.	It is invalid at the time of CD operation.
81	A display of PI error detection number of the outer circumference of 1-layer and an address.	CD : C1 error detection number (x3)
82	A display of PI uncorrectable number of the outer circumference of 1-layer and an address.	It is invalid at the time of CD operation.
83	A display of PO error detection number of the inner circumference of 2-layer and an address.	In the case of 1-layer DVD and CD disc, it is invalid.
84	A display of PO uncorrectable number of the inner circumference of 2-layer and an address.	In the case of 1-layer DVD and CD disc, it is invalid.
85	A display of PI error detection number of the inner circumference of 2-layer and an address.	In the case of 1-layer DVD and CD disc, it is invalid.
86	A display of PI uncorrectable number of the inner circumference of 2-layer and an address.	In the case of 1-layer DVD and CD disc, it is invalid.
87	A display of PO error detection number of the central circumference of 2-layer and an address.	In the case of 1-layer DVD and CD disc, it is invalid.
88	A display of PO uncorrectable number of the central circumference of 2-layer and an address.	In the case of 1-layer DVD and CD disc, it is invalid.
89	A display of PI error detection number of the central circumference of 2-layer and an address.	In the case of 1-layer DVD and CD disc, it is invalid.
90	A display of PI uncorrectable number of the central circumference of 2-layer and an address.	In the case of 1-layer DVD and CD disc, it is invalid.
91	A display of PO error detection number of the outer circumference of 2-layer and an address.	In the case of 1-layer DVD and CD disc, it is invalid.
92	A display of PO uncorrectable number of the outer circumference of 2-layer and an address.	In the case of 1-layer DVD and CD disc, it is invalid.
93	A display of PI error detection number of the outer circumference of 2-layer and an address.	In the case of 1-layer DVD and CD disc, it is invalid.
94	A display of PI uncorrectable number of the outer circumference of 2-layer and an address.	In the case of 1-layer DVD and CD disc, it is invalid.

表 2 トレースモード詳細

YY	内容	補足説明
71	1層内周のPO誤り検出数とアドレスの表示	CD時は無効。
72	1層内周のPO訂正不可数とアドレスの表示	CD時は無効。
73	1層内周のPI誤り検出数とアドレスの表示	CD時はC1誤り検出数。(x3)
74	1層内周のPI訂正不可数とアドレスの表示	CD時は無効。
75	1層中周のPO誤り検出数とアドレスの表示	CD時は無効。
76	1層中周のPO訂正不可数とアドレスの表示	CD時は無効。
77	1層中周のPI誤り検出数とアドレスの表示	CD時はC1誤り検出数。(x3)
78	1層中周のPI訂正不可数とアドレスの表示	CD時は無効。
79	1層外周のPO誤り検出数とアドレスの表示	CD時は無効。
80	1層外周のPO訂正不可数とアドレスの表示	CD時は無効。
81	1層外周のPI誤り検出数とアドレスの表示	CD時はC1誤り検出数。(x3)
82	1層外周のPI訂正不可数とアドレスの表示	CD時は無効。
83	2層内周のPO誤り検出数とアドレスの表示	DVD1層ディスクの場合、無効。 CD時は無効。
84	2層内周のPO訂正不可数とアドレスの表示	DVD1層ディスクの場合、無効。 CD時は無効。
85	2層内周のPI誤り検出数とアドレスの表示	DVD1層ディスクの場合、無効。 CD時は無効。
86	2層内周のPI訂正不可数とアドレスの表示	DVD1層ディスクの場合、無効。 CD時は無効。
87	2層中周のPO誤り検出数とアドレスの表示	DVD1層ディスクの場合、無効。 CD時は無効。
88	2層中周のPO訂正不可数とアドレスの表示	DVD1層ディスクの場合、無効。 CD時は無効。
89	2層中周のPI誤り検出数とアドレスの表示	DVD1層ディスクの場合、無効。 CD時は無効。
90	2層中周のPI訂正不可数とアドレスの表示	DVD1層ディスクの場合、無効。 CD時は無効。
91	2層外周のPO誤り検出数とアドレスの表示	DVD1層ディスクの場合、無効。 CD時は無効。
92	2層外周のPO訂正不可数とアドレスの表示	DVD1層ディスクの場合、無効。 CD時は無効。
93	2層外周のPI誤り検出数とアドレスの表示	DVD1層ディスクの場合、無効。 CD時は無効。
94	2層外周のPI訂正不可数とアドレスの表示	DVD1層ディスクの場合、無効。 CD時は無効。

# TROUBLE SHOOTING

## ● ADV-S302

### 1. 1U-3808 (MAIN UNIT)

#### 1.1. FL TUBE dosen't light

(1) Check the Set-up process of System μ-COM

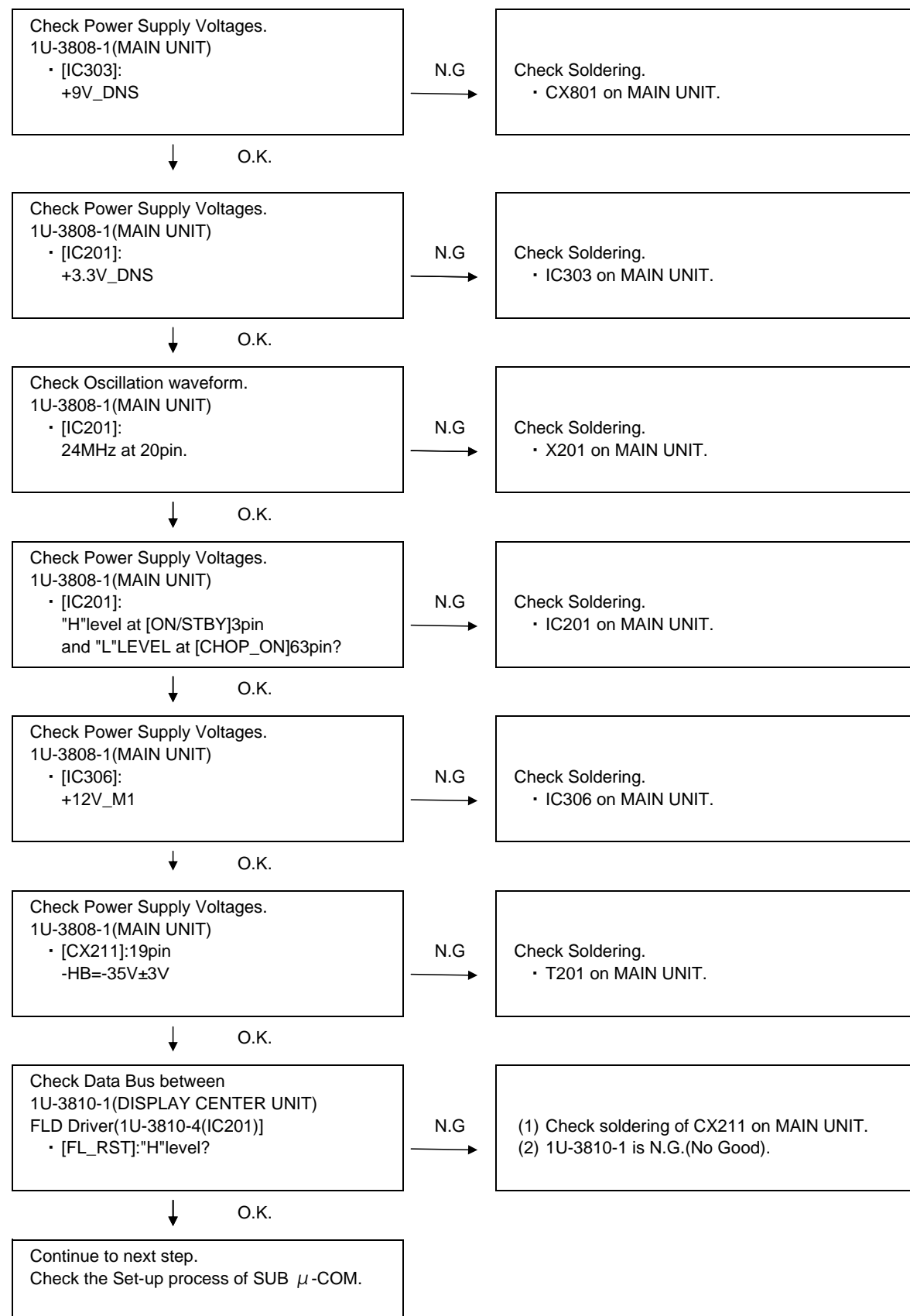

# トラブルシューティング

## ● ADV S302

### 1. 1U-3808 (MAIN UNIT)

#### 1.1. FL管点灯せず

(1) システムμ-COM 立ち上がりチェック工程

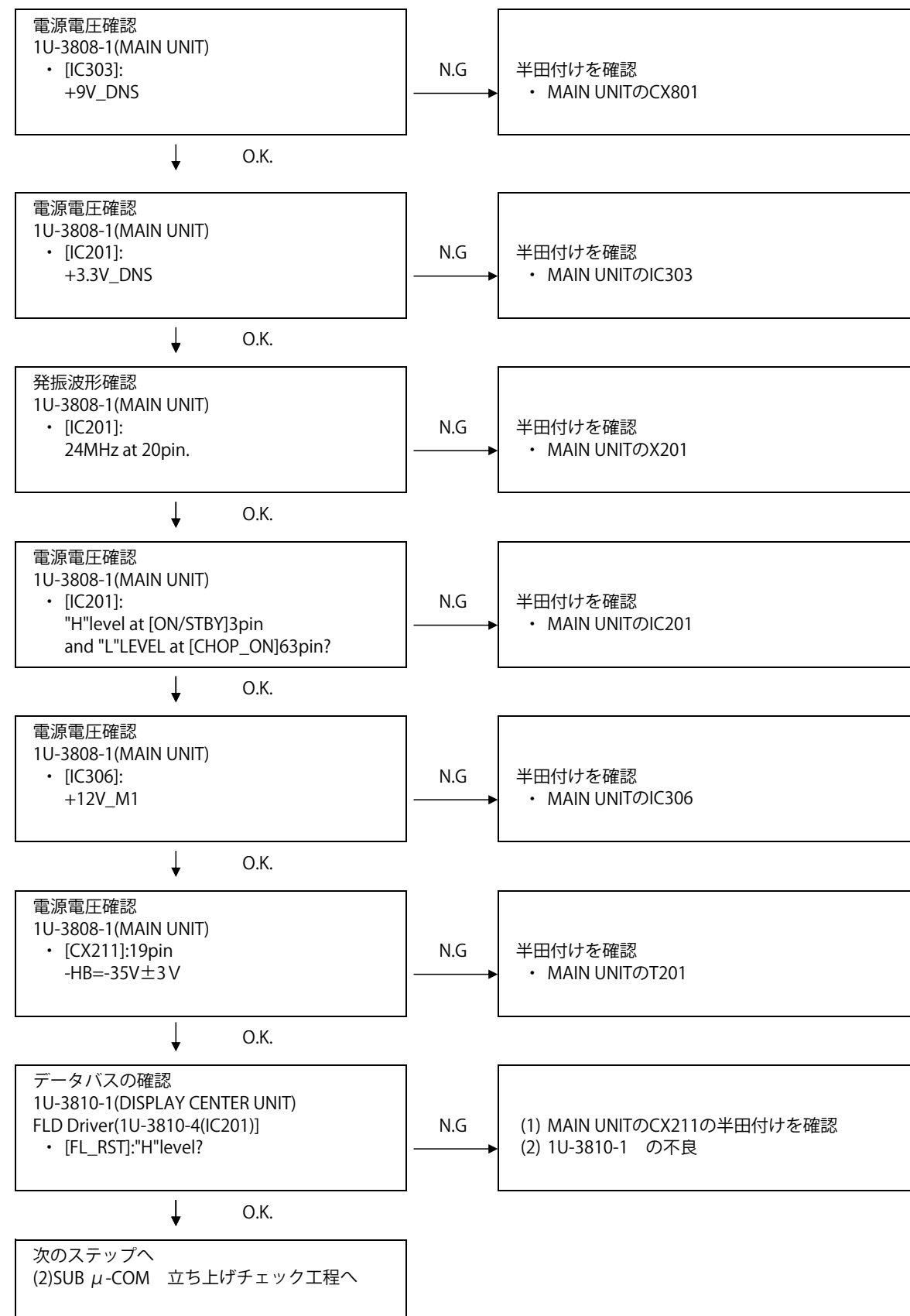

(2) Check the Set-up process of SUB μ-COM

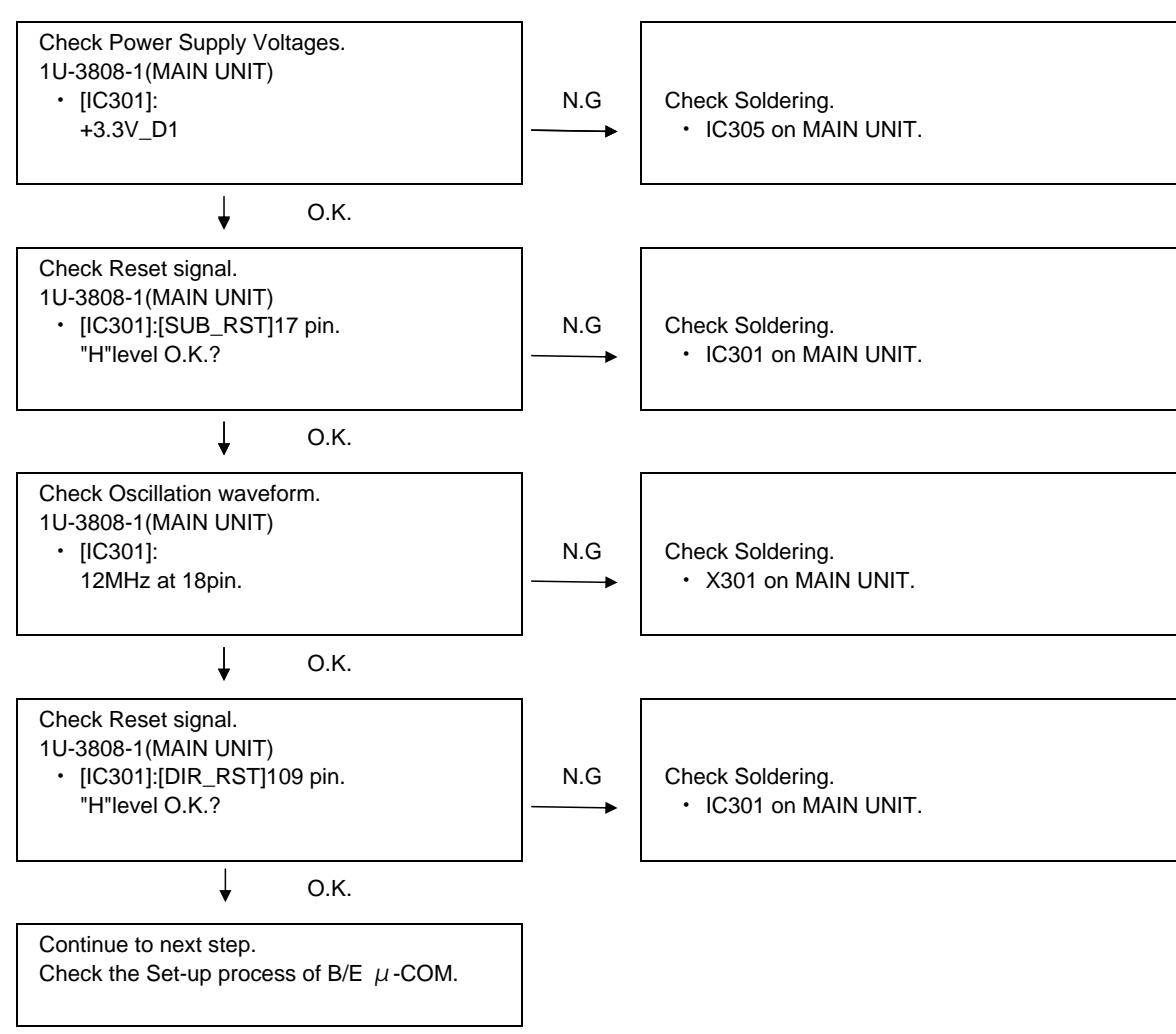

(2) サブμ-COM 立ち上がりチェック工程

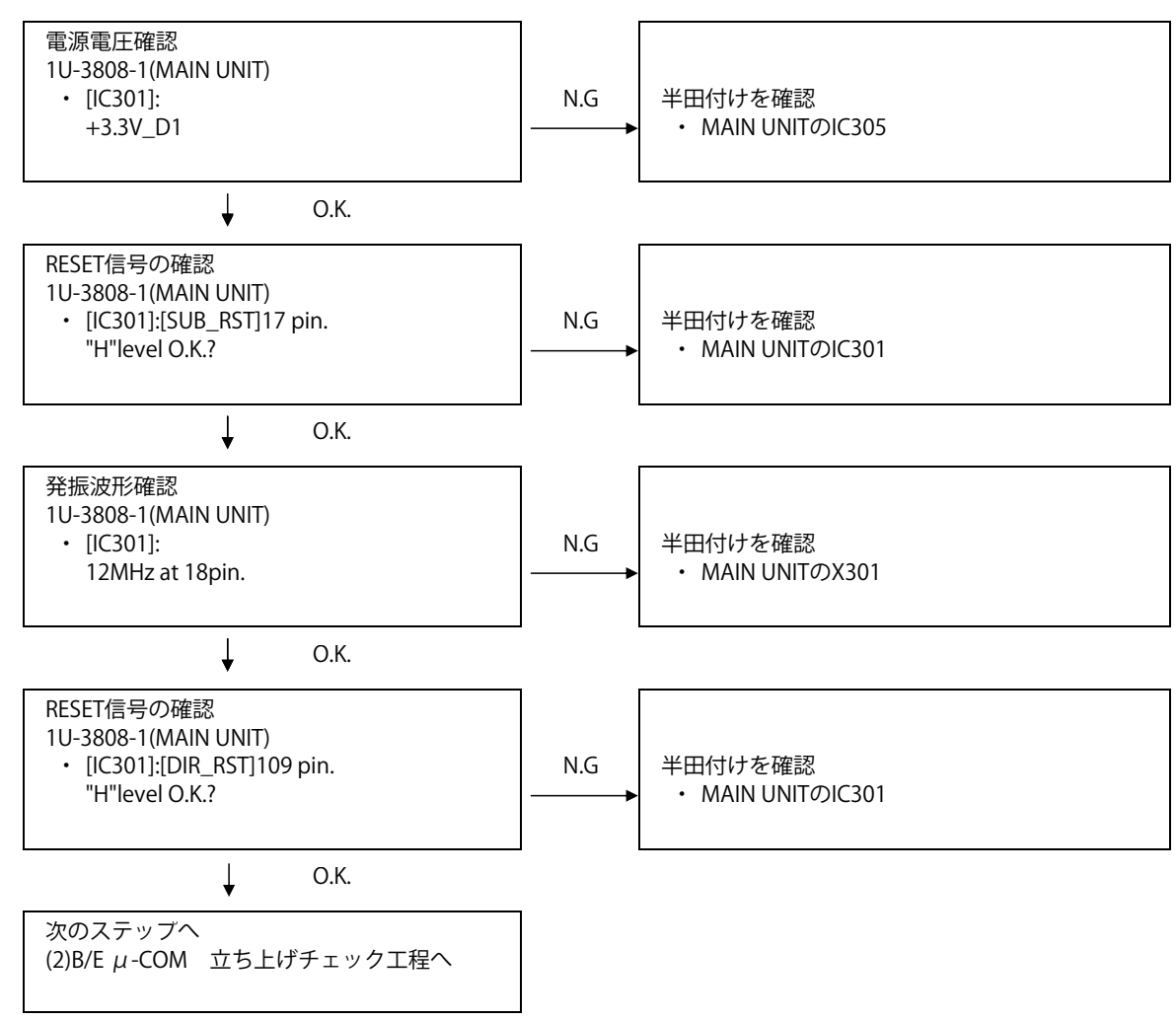



(3) Check the Set-up process of B/E μ-COM

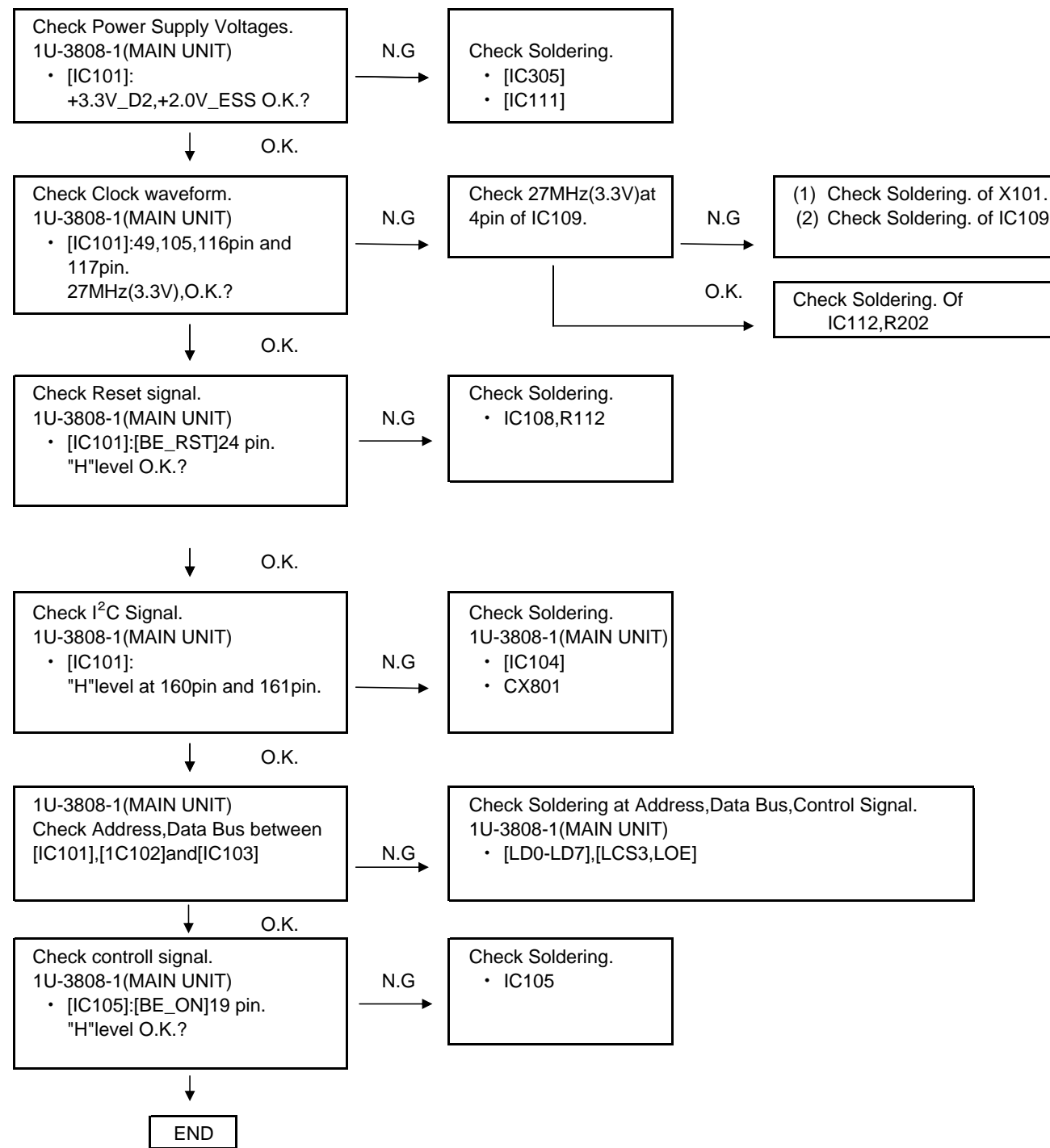

(3) B/E μ-COM 立ち上がりチェック工程

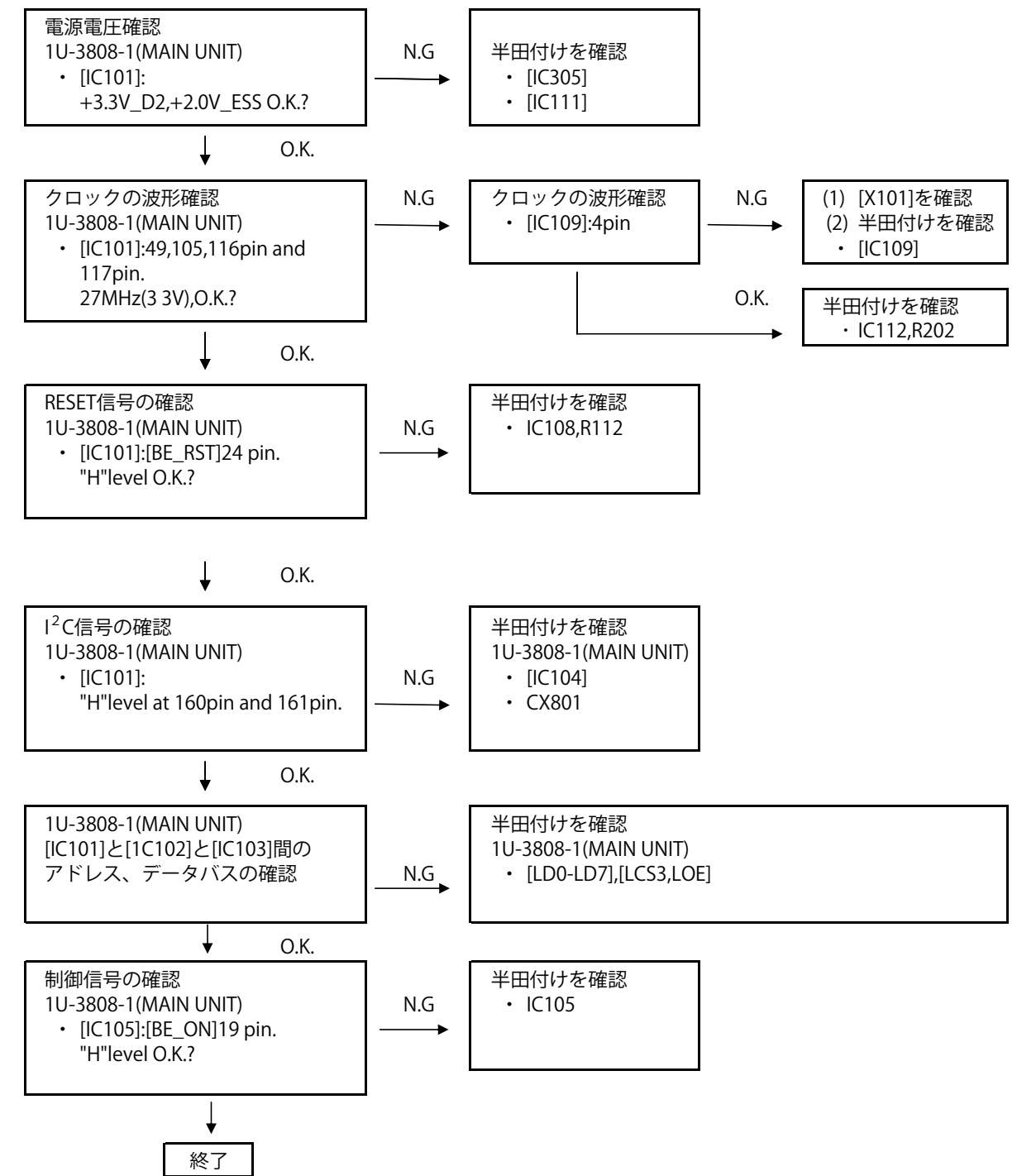



### 1.2. No Sound,Noise generated [No Play], [00 00] displayed etc.

(1) CD,DVD PLAY

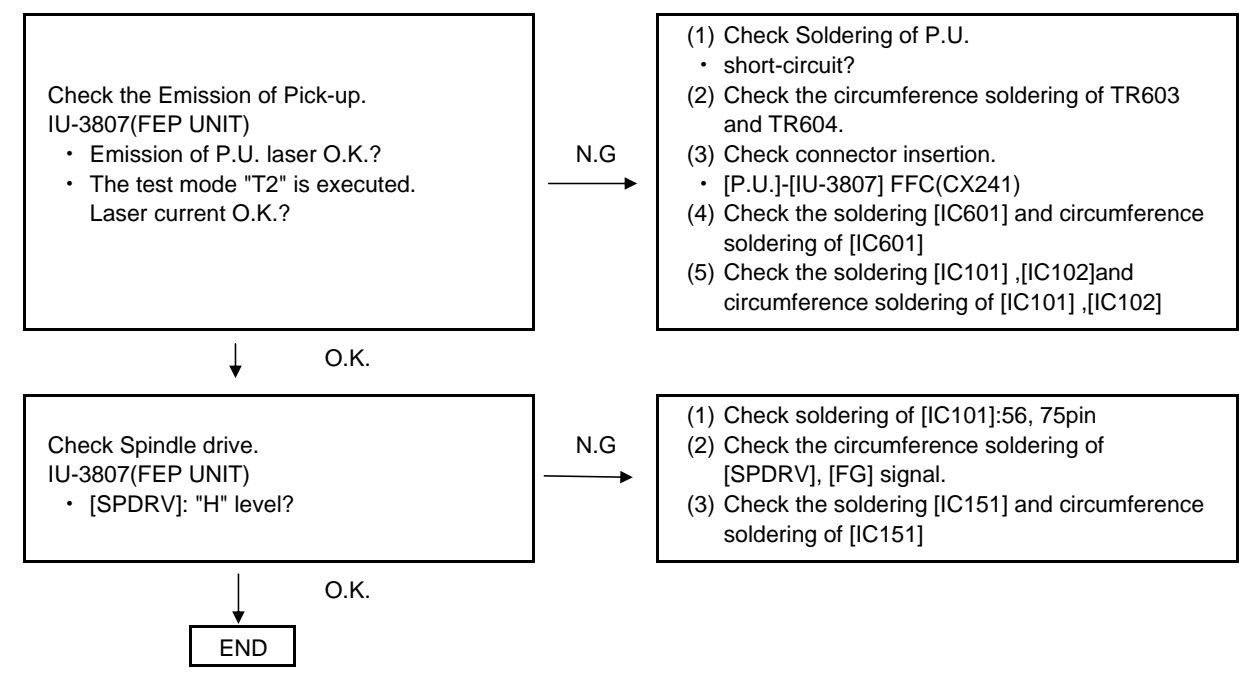

(2) CD or DVD check process

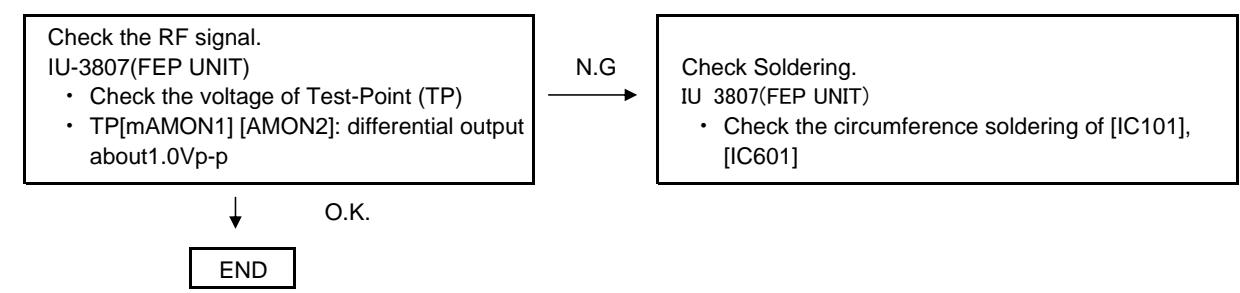

### 1.2. ディスク読めず [No Play], [00 00] 等の表示

(1) ディスク回転せず

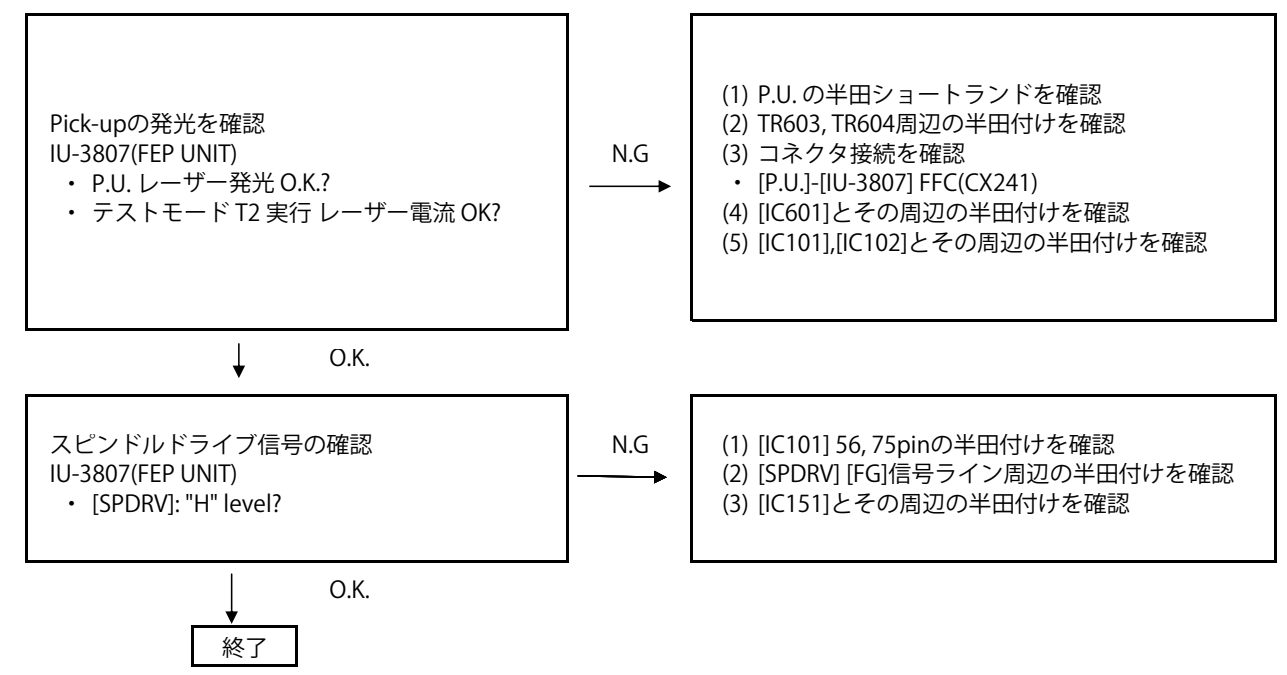

(2) CD or DVD チェック工程

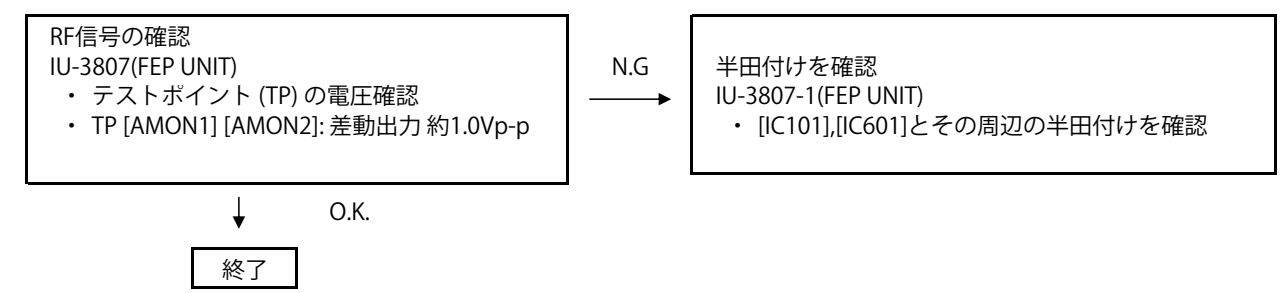

### 1.3. No Sound,Noise generated

(1) CD,DVD PLAY

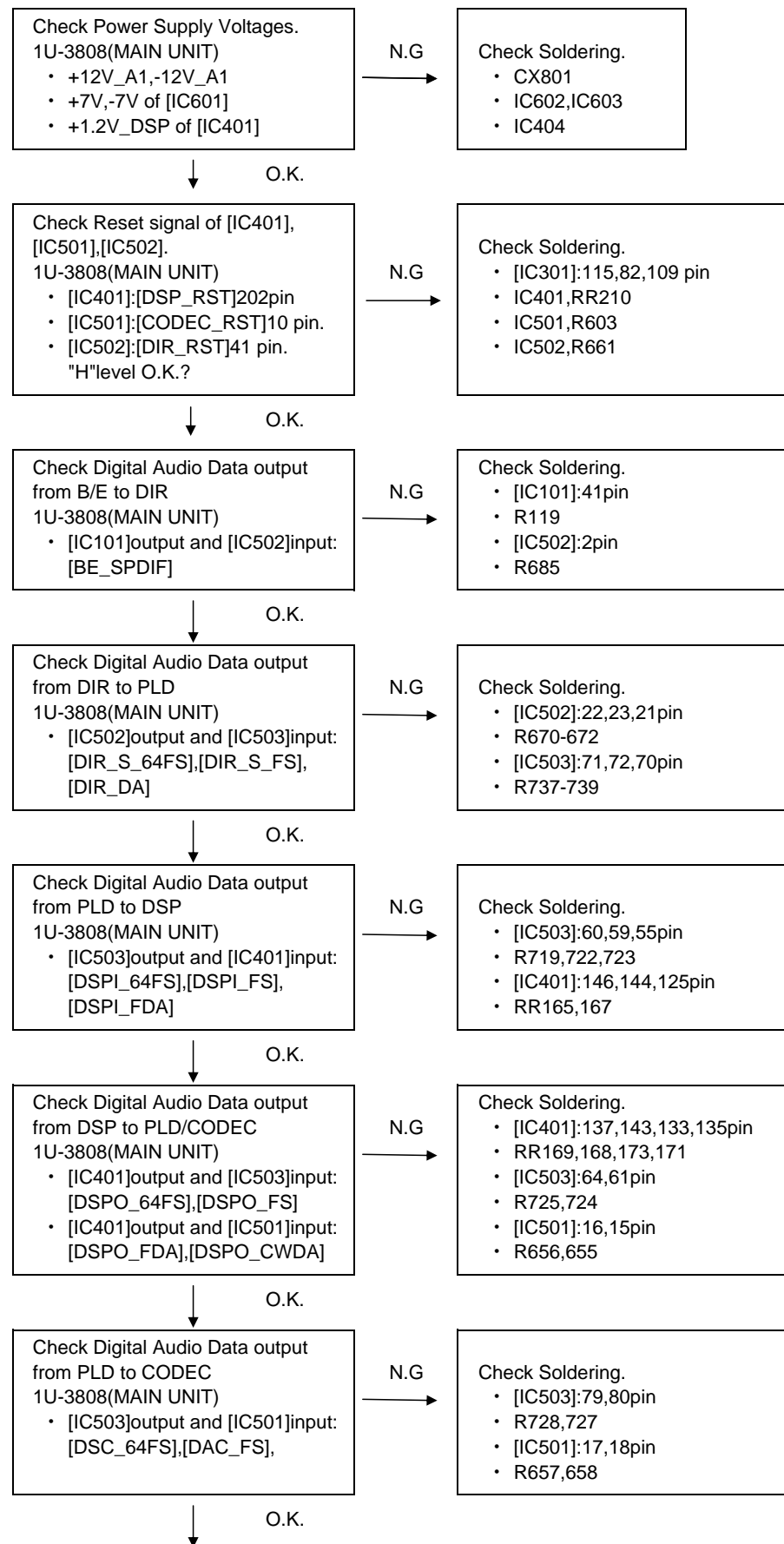

### 1.3. 音声出力せず、ノイズ発生

(1) CD,DVD 再生時

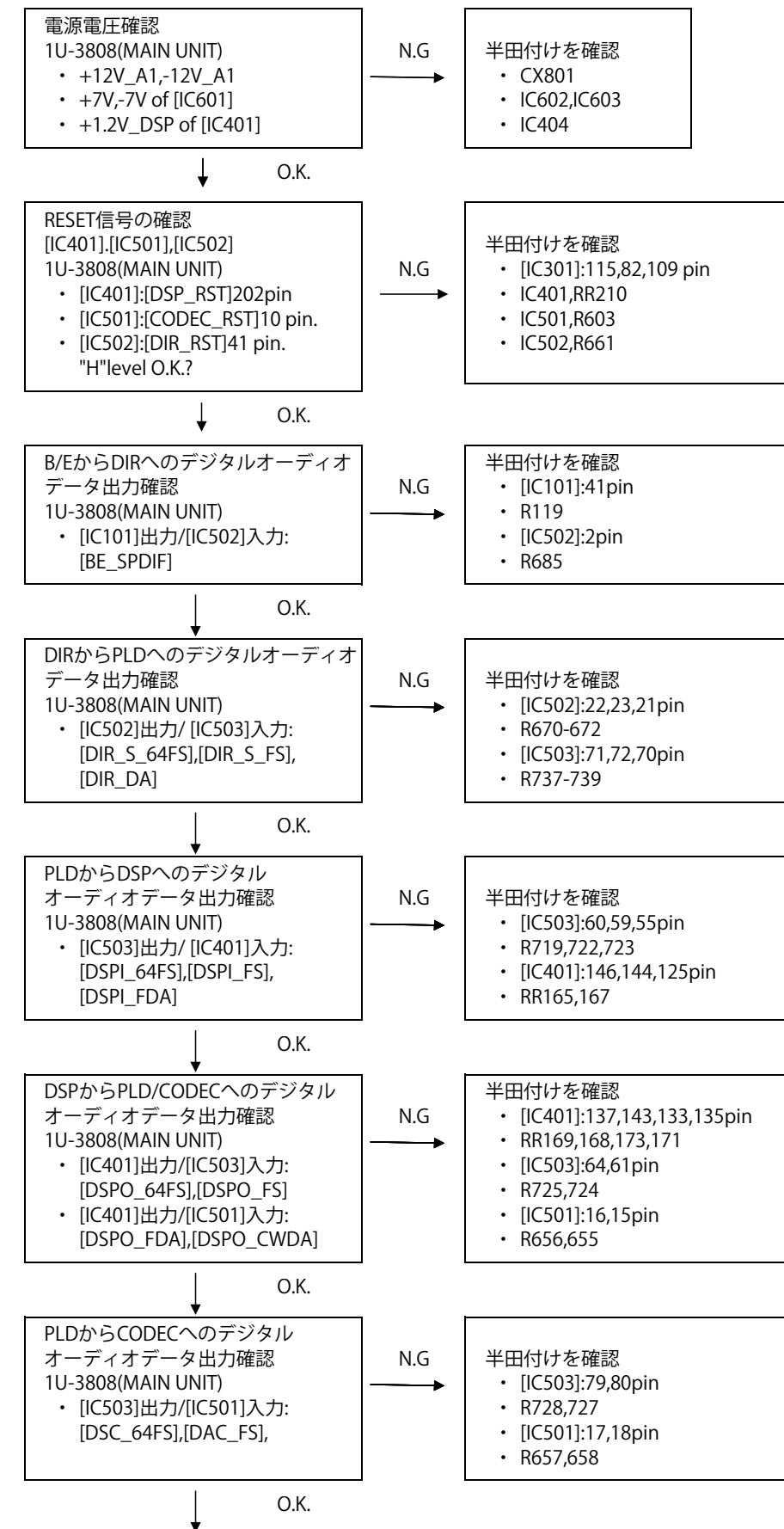

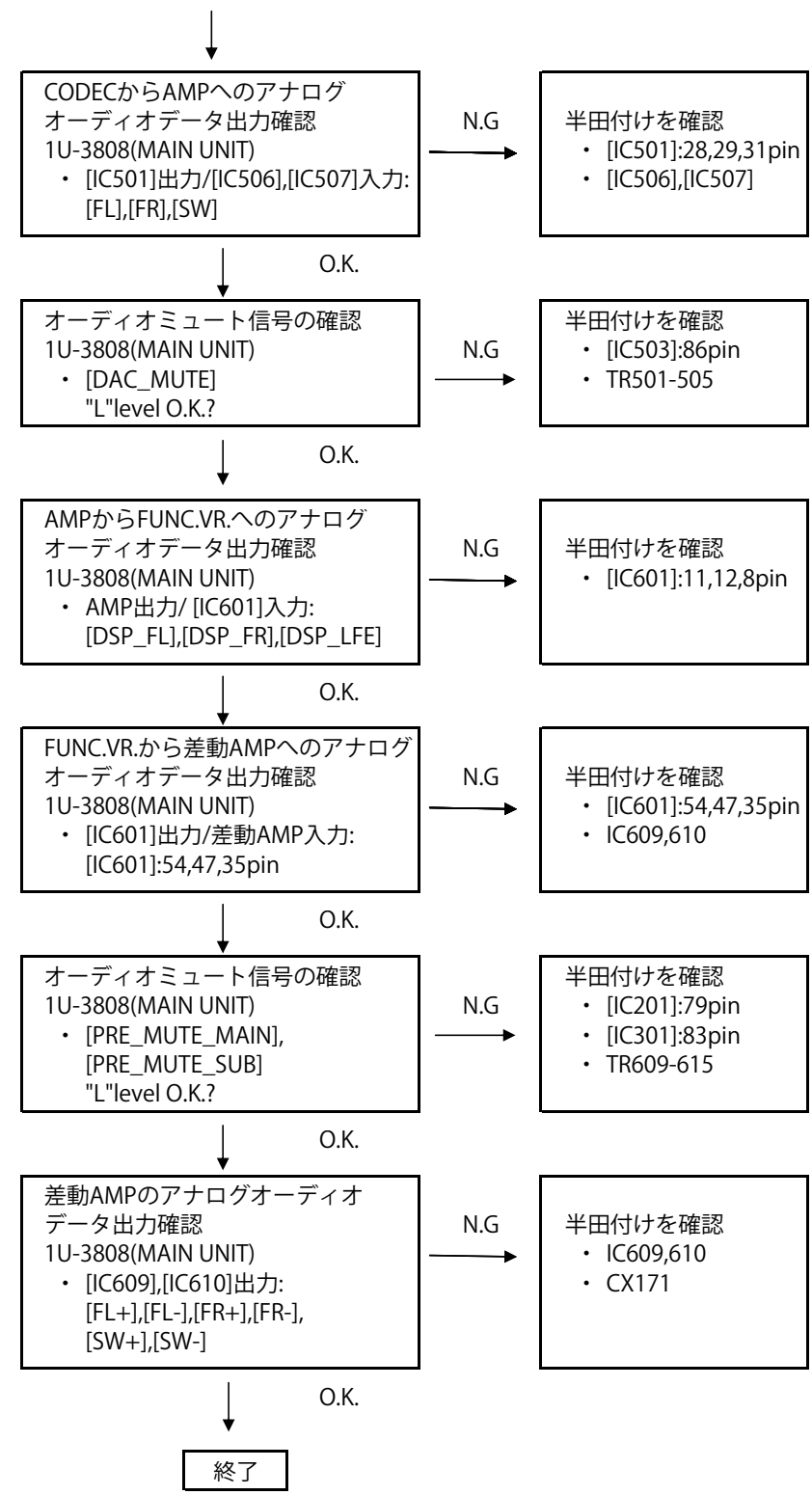
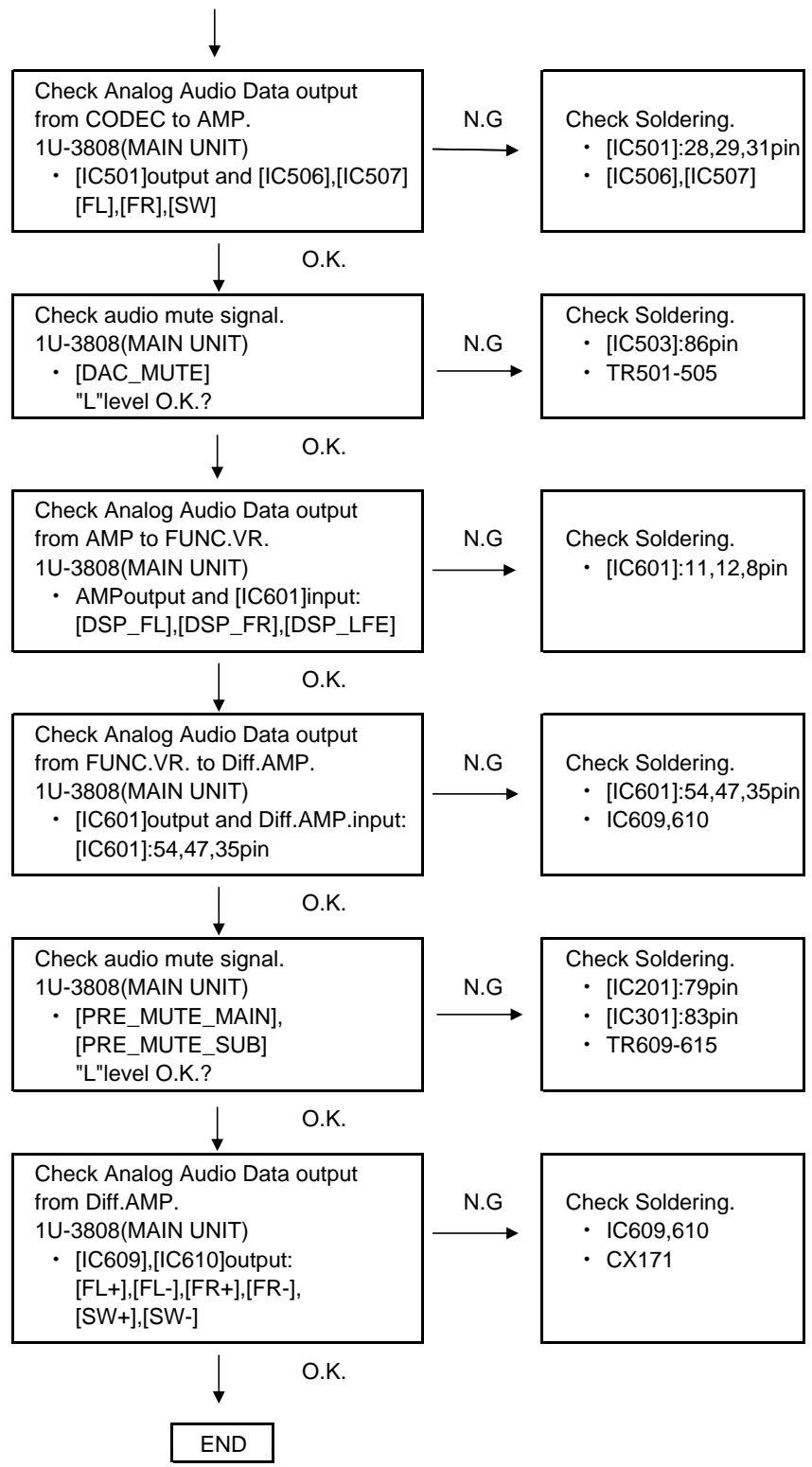

(2) Analog audio in(AUX1,AUX2,AUX3)

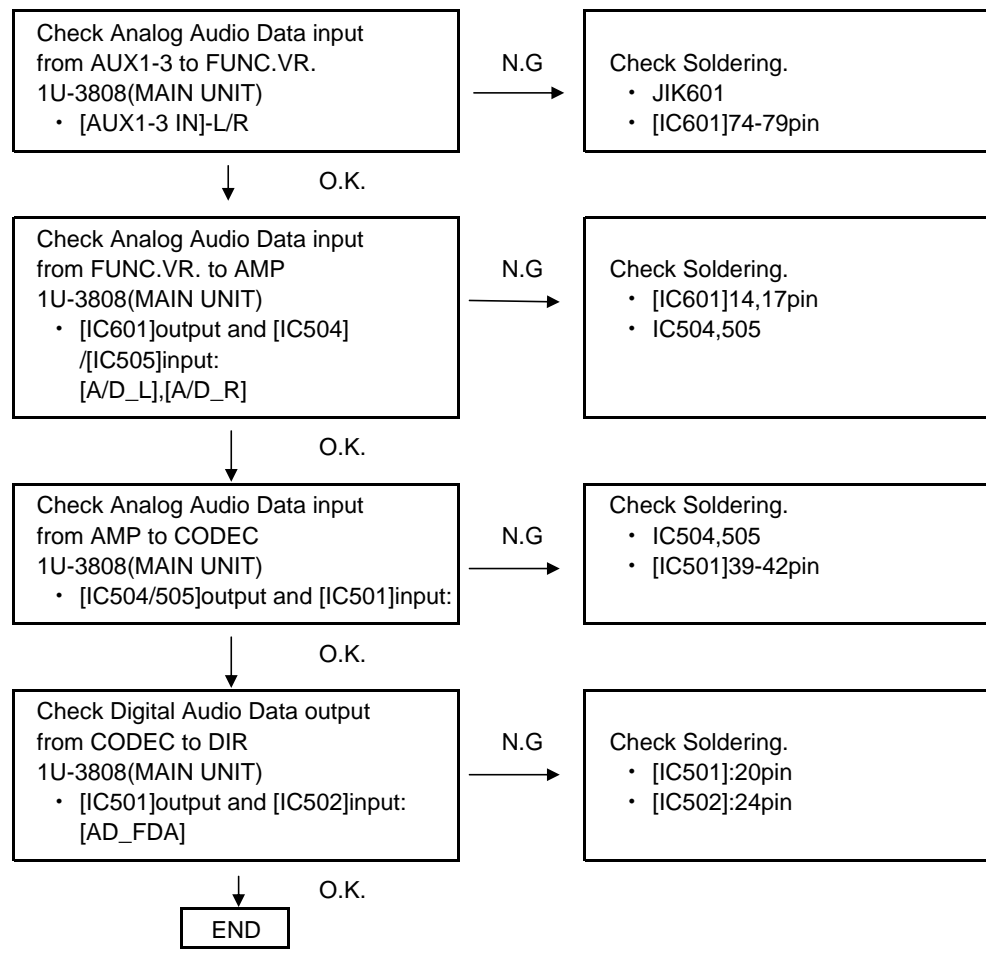

(2) アナログオーディオ入力時(AUX1,AUX2,AUX3)

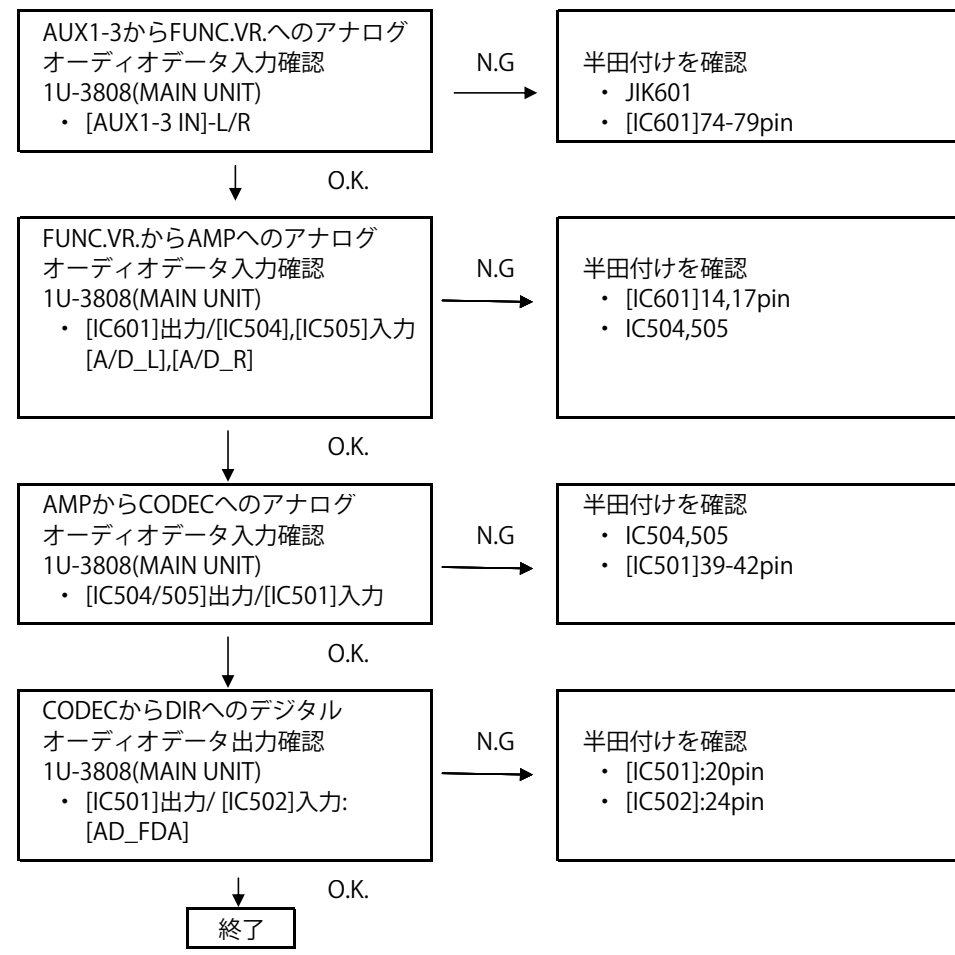

(3) Digital audio in

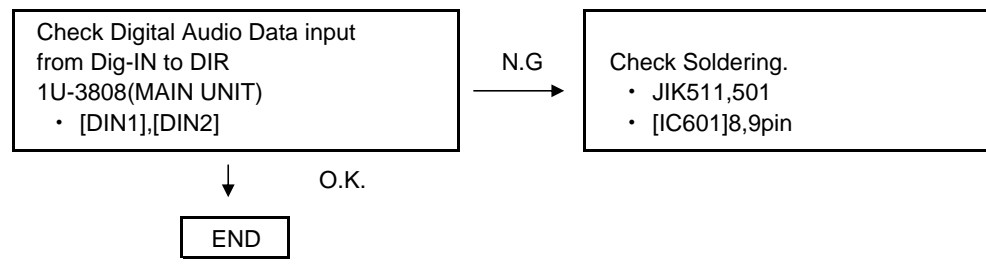

(3) デジタルオーディオ入力時

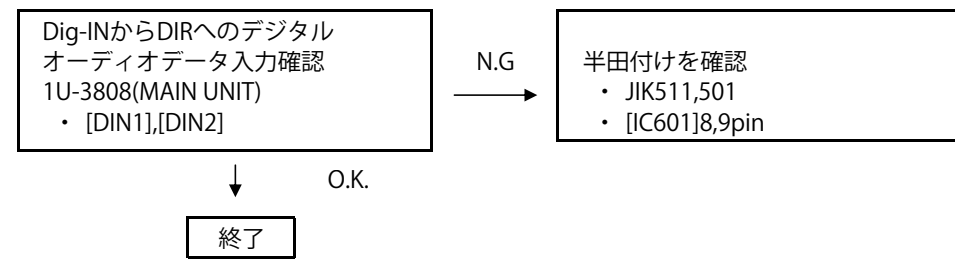

### 3. 1U-3809-1 (VIDEO UNIT) 3-1.DVD PLAY

(1) INTERLACE output does not outputed.

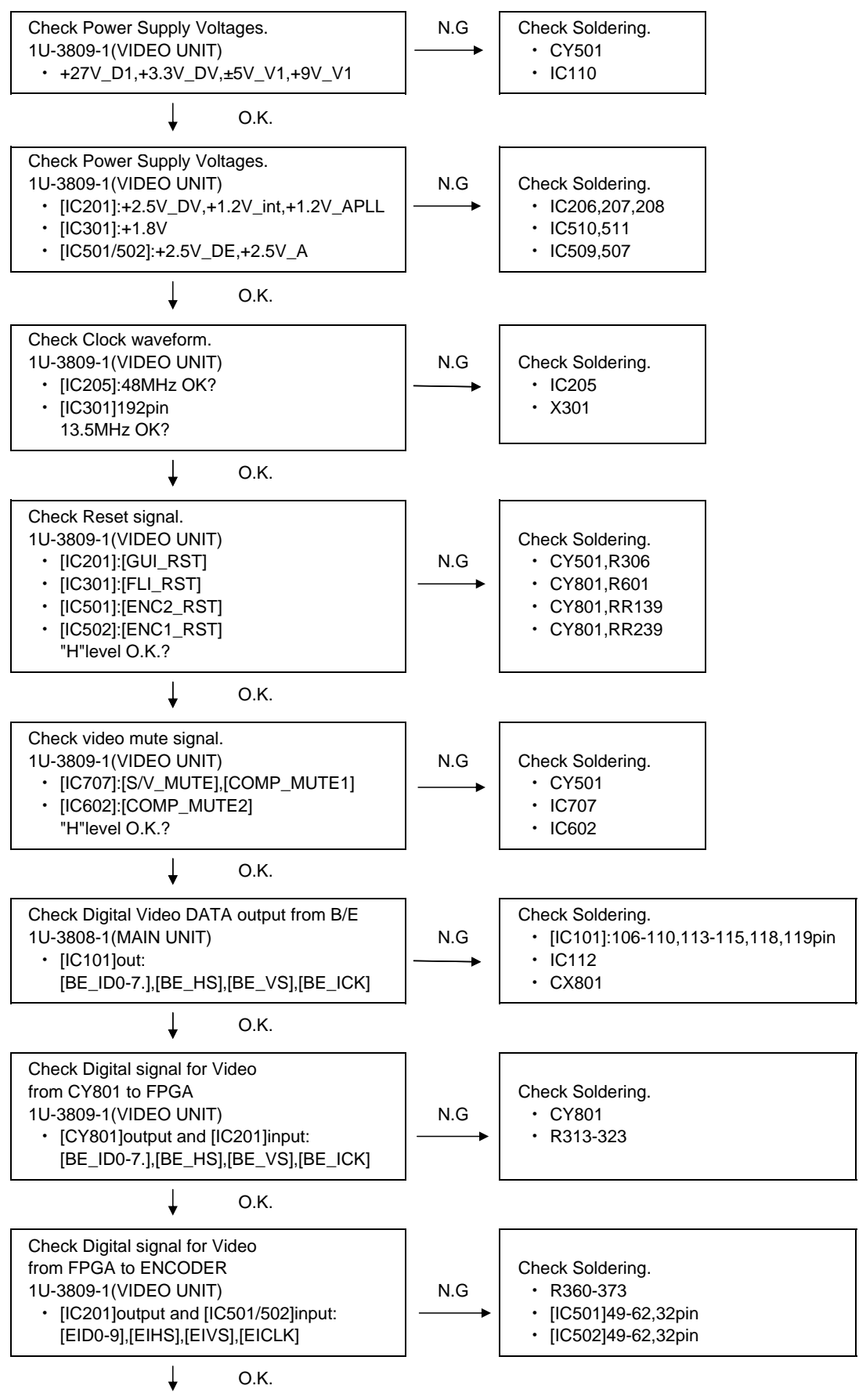

### 3. 1U-3809-1 (VIDEO UNIT) 3-1.DVD 再生時

(1) インターレース映像出力せず

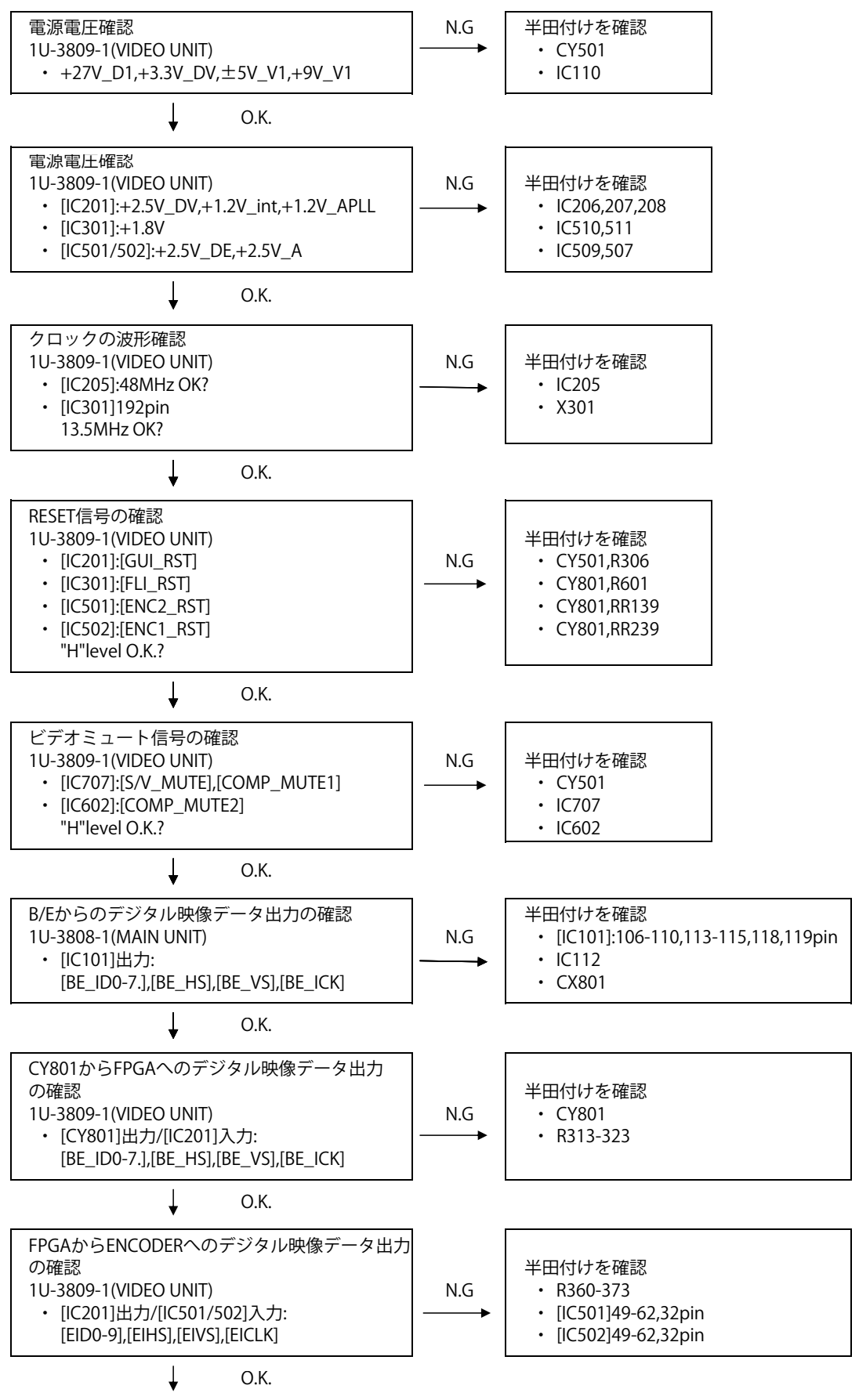

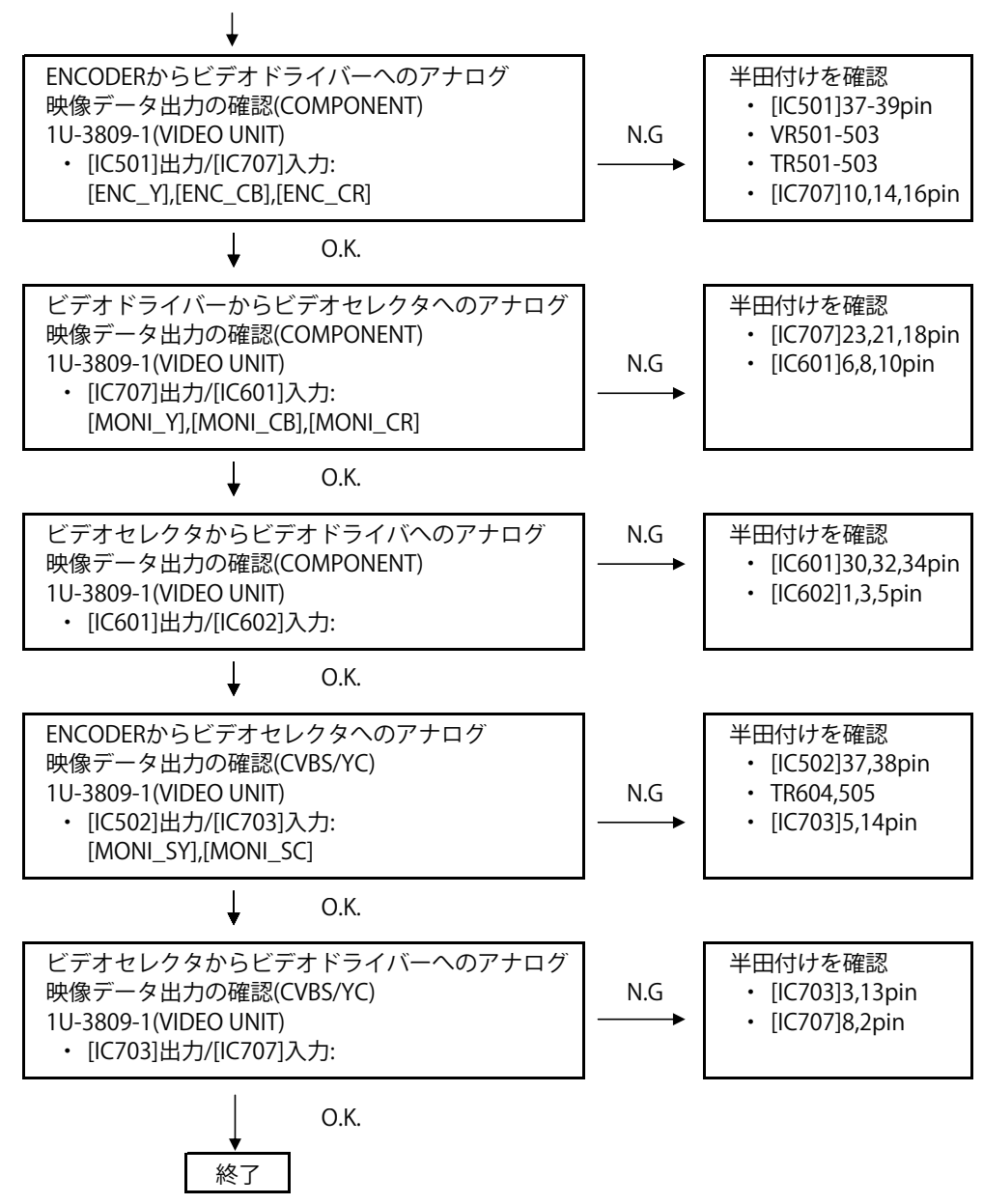
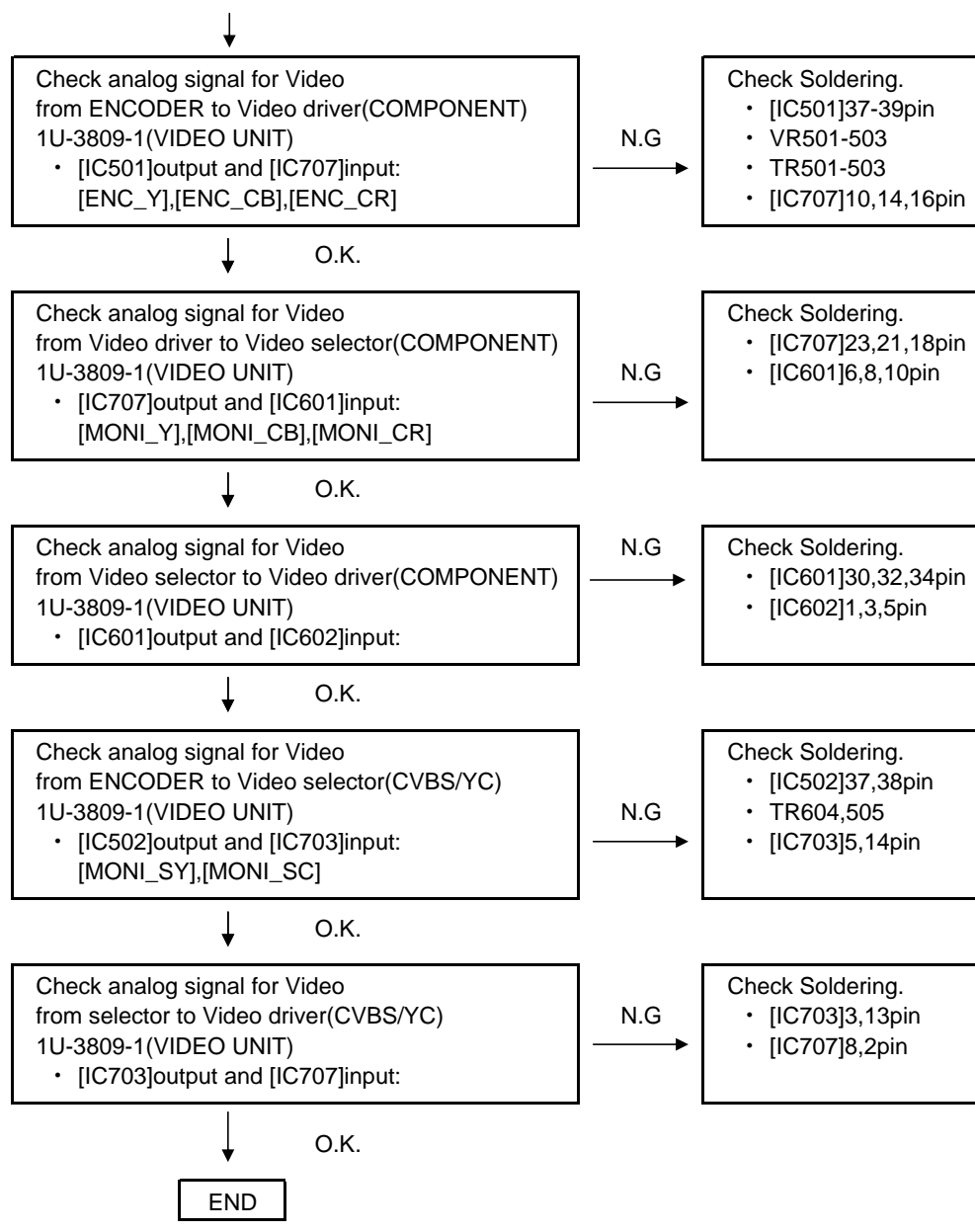

(2) PROGRESSIVE output does not outputed.

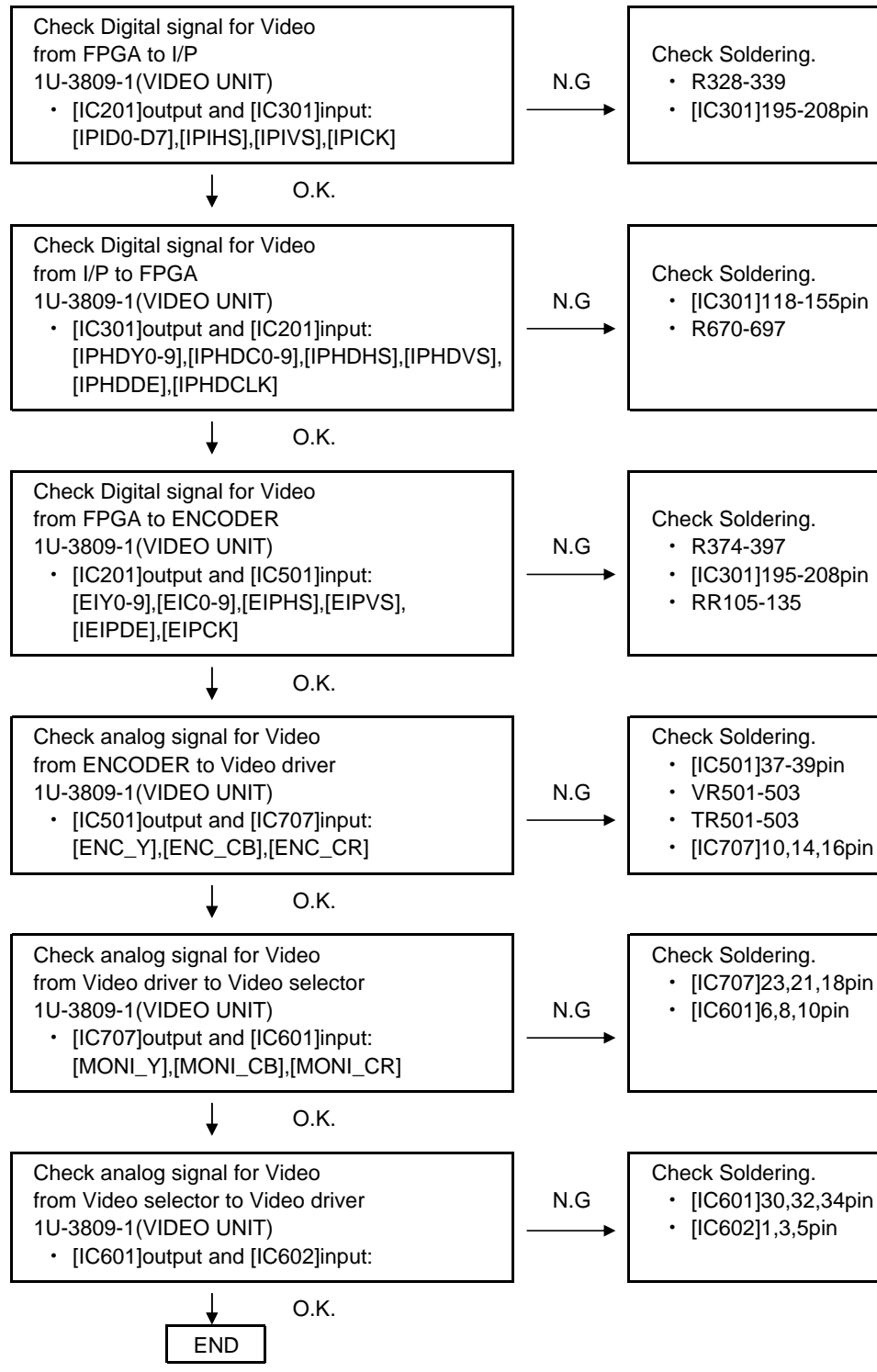

(2) プログレッシブ映像出力せず

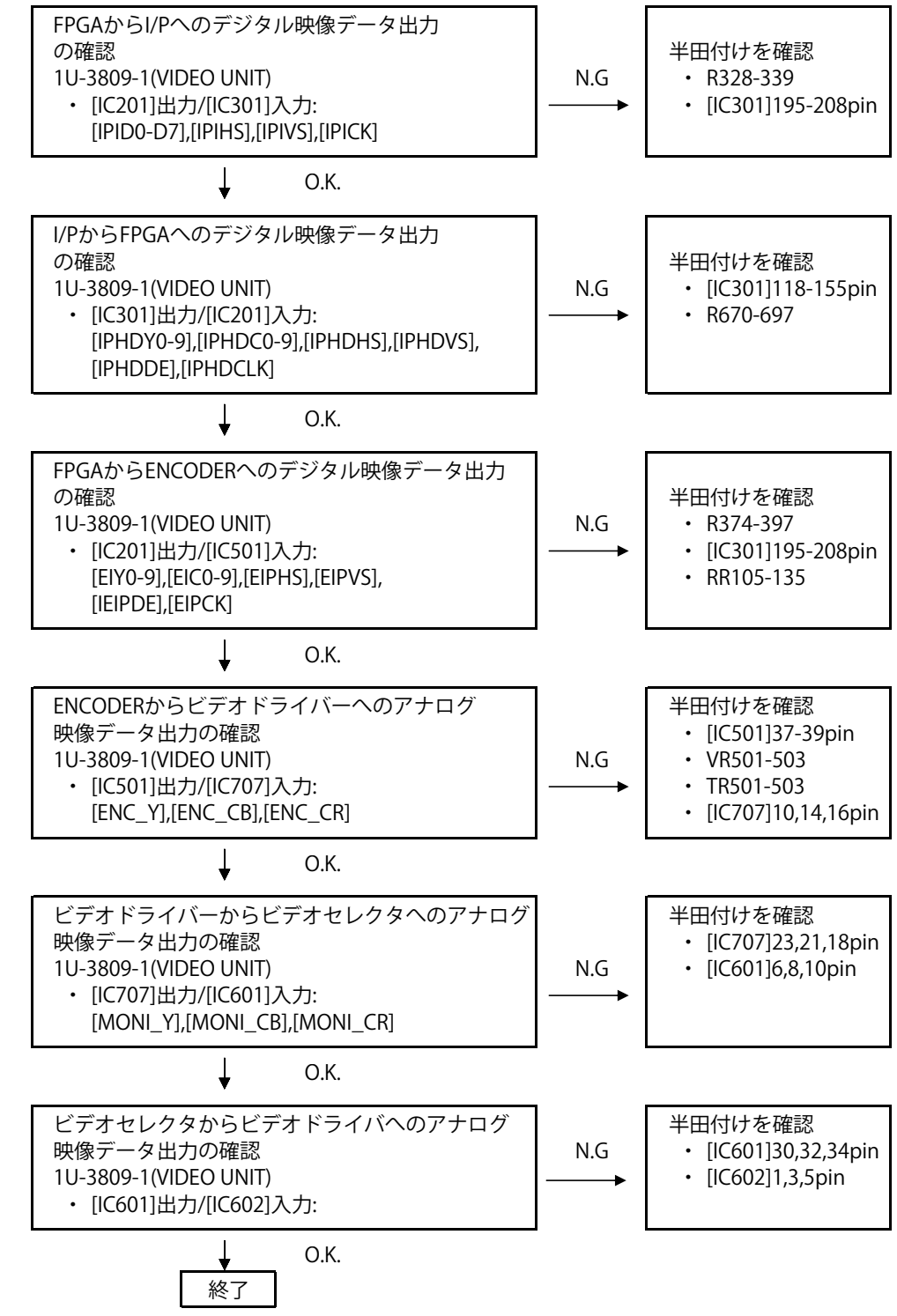

(3) HDMI output does not outputed.

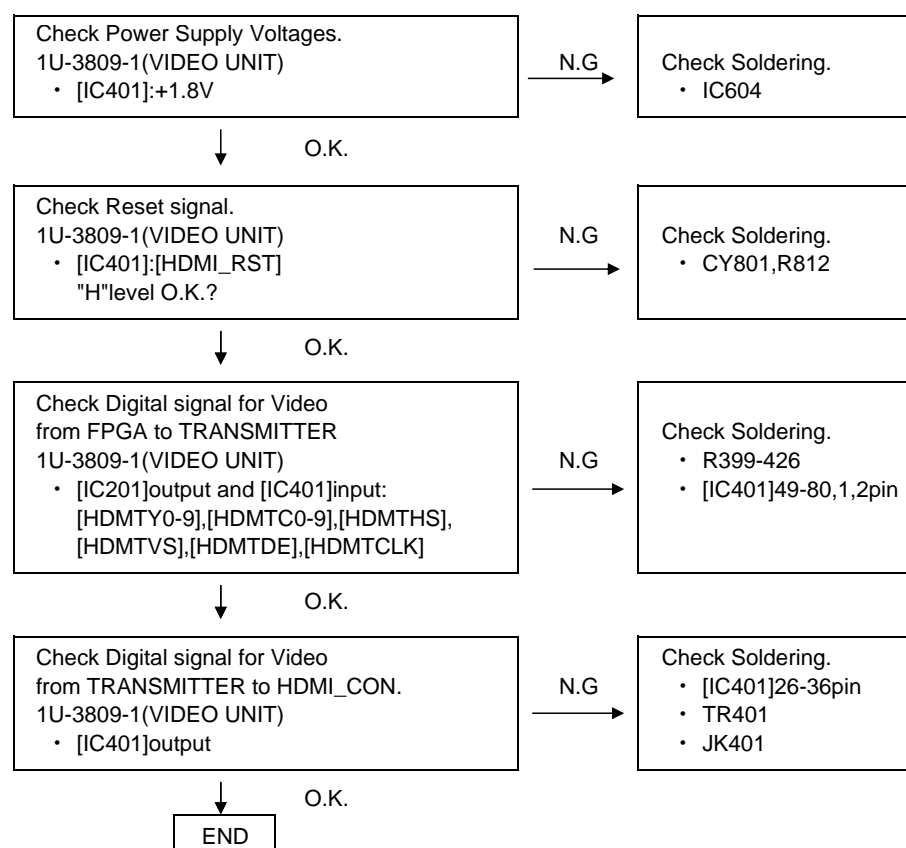

3-2.AUX IN

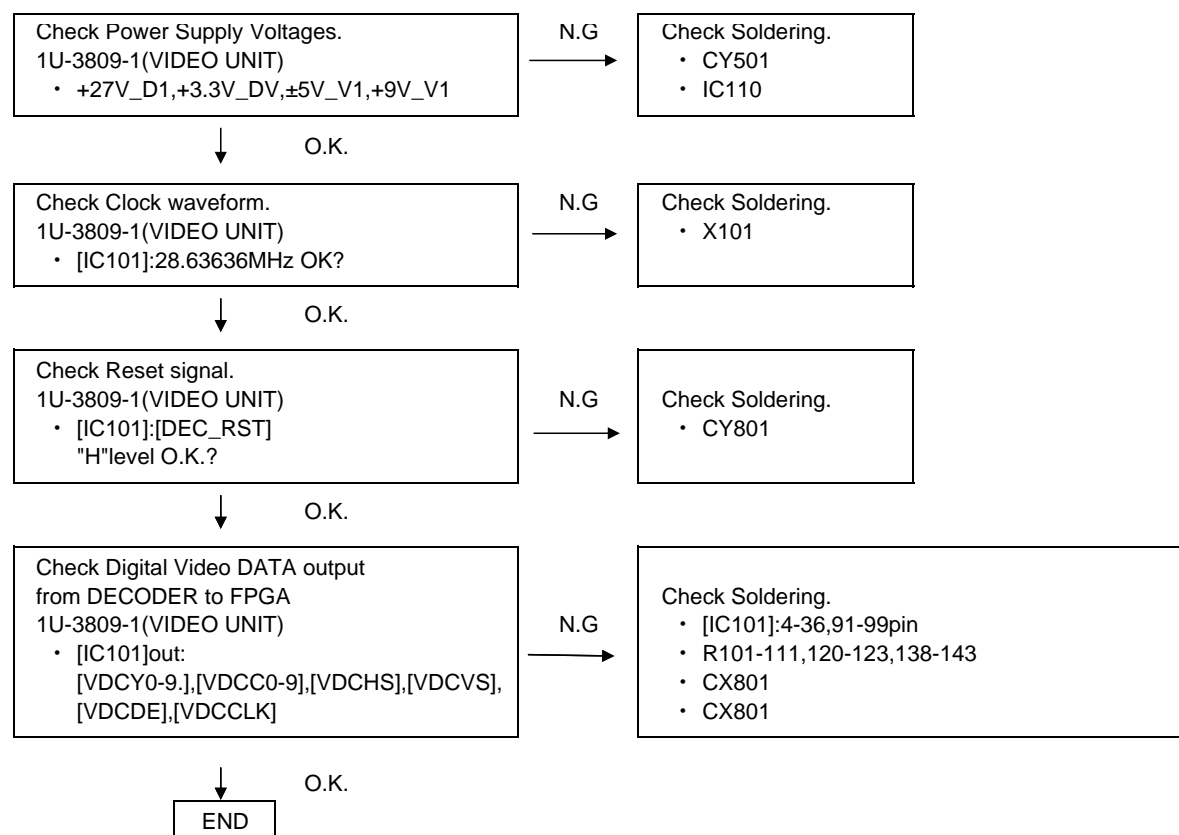

(3) HDMI映像出力せず

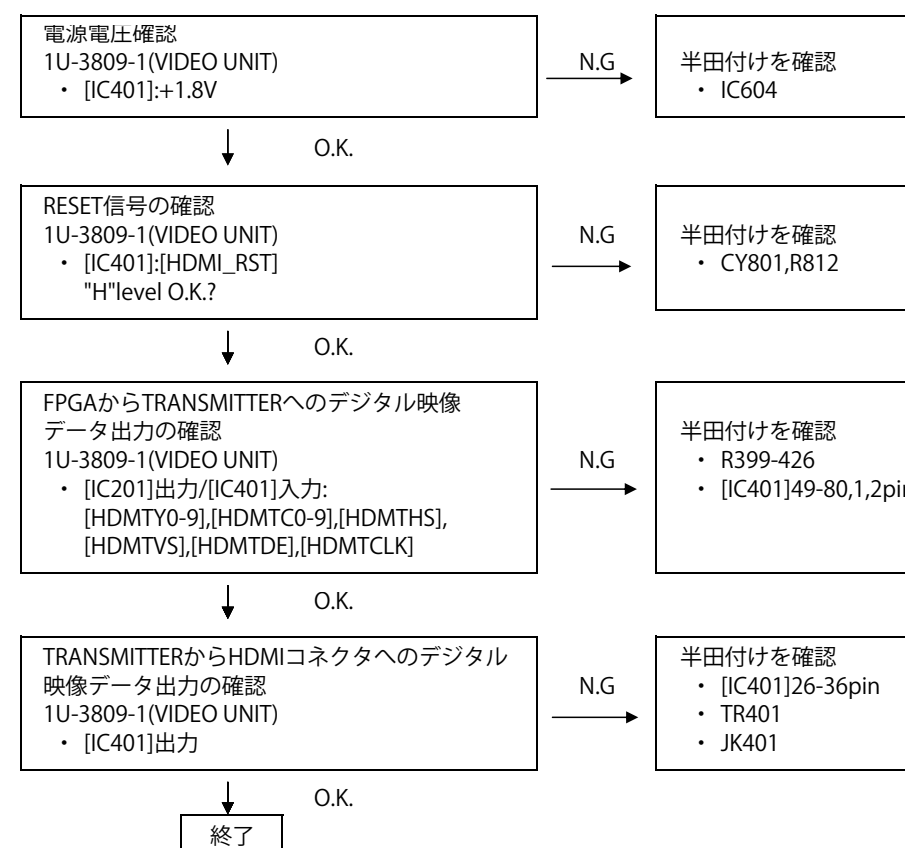

3-2.外部入力時

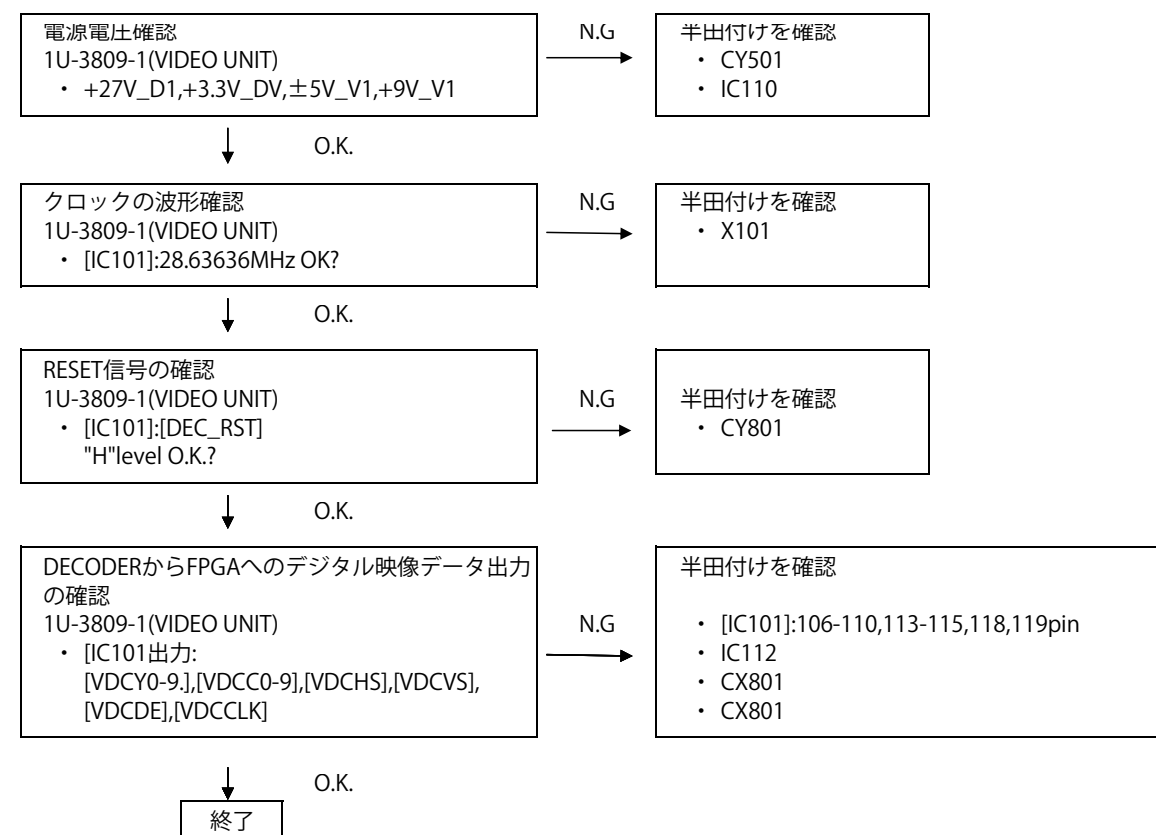



● DSW-S302

1. 1U-3811 (D.AMP/SMPS UNIT)

(1) AMPLIFIER

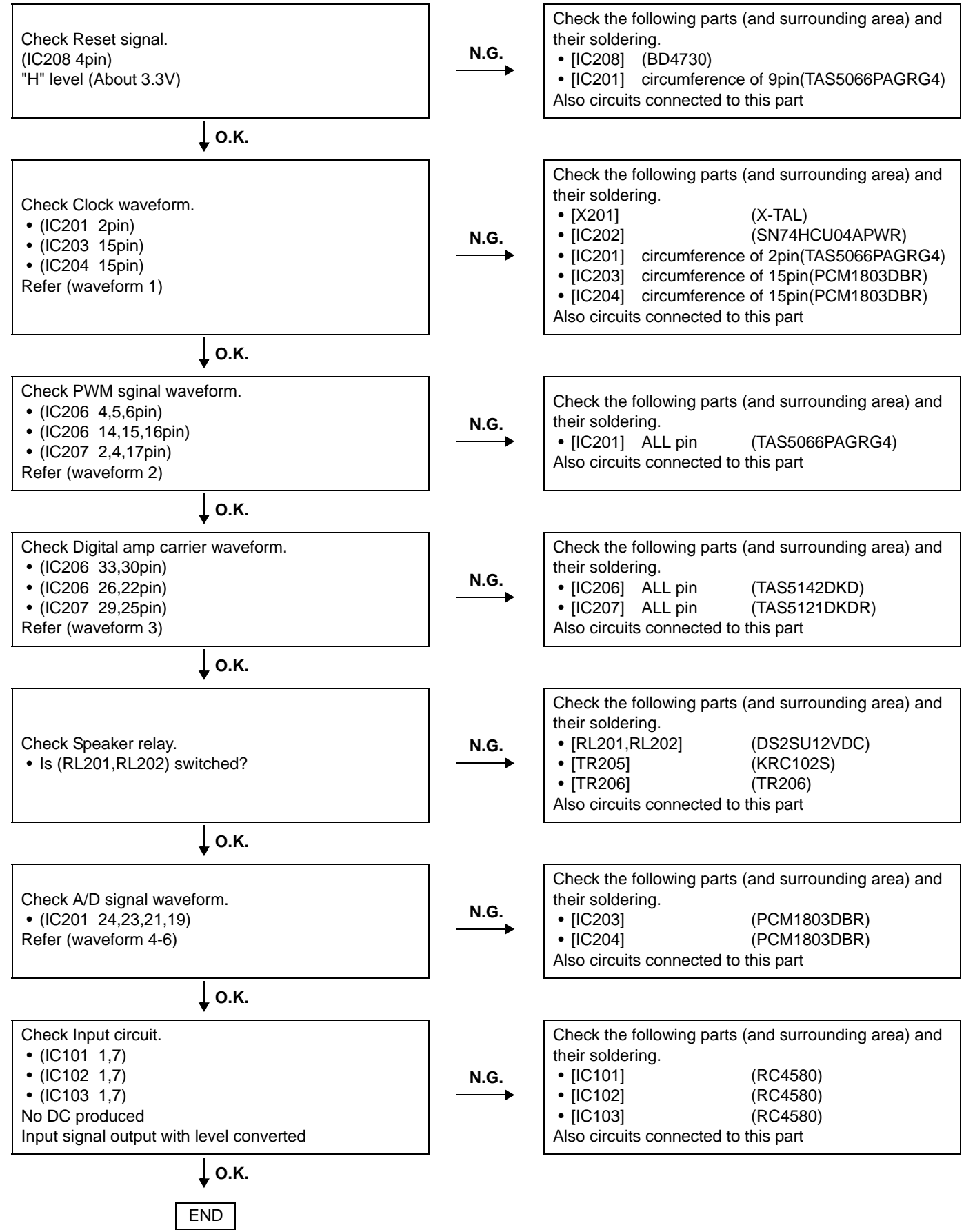

● DSW-S302

1. 1U-3811 (D.AMP/SMPS UNIT)

(1) アンプ



(2) WAVEFORM

(2) 波形図

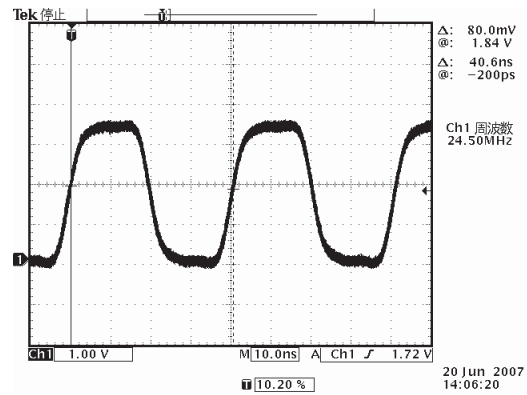

Waveform 1:Clock Waveform (24.576MHz)

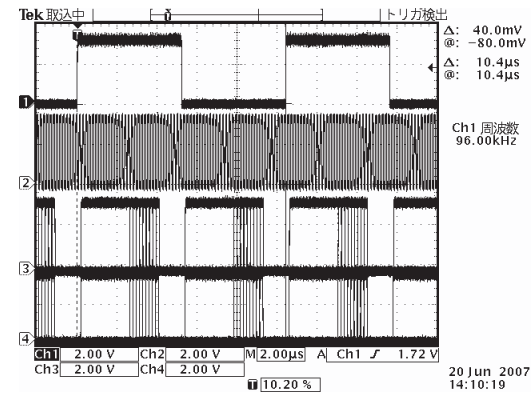

Waveform 4: A/D Waveform 1

CH1:IC201 24pin  
 CH2:IC201 23pin  
 CH3:IC201 21pin  
 CH4:IC201 19pin

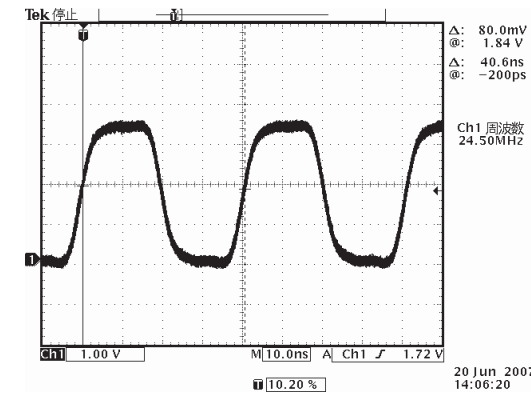

波形1:クロック波形 (24.576MHz)

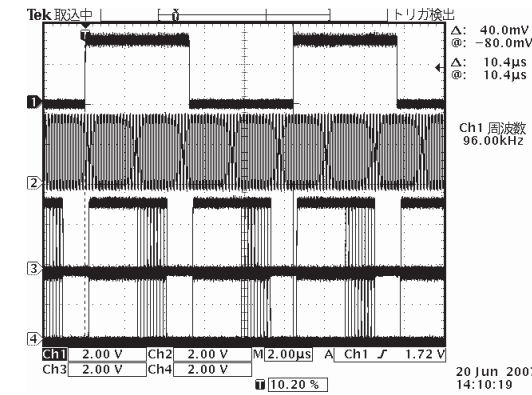

波形4: A/D波形 1

CH1:IC201 24pin  
 CH2:IC201 23pin  
 CH3:IC201 21pin  
 CH4:IC201 19pin

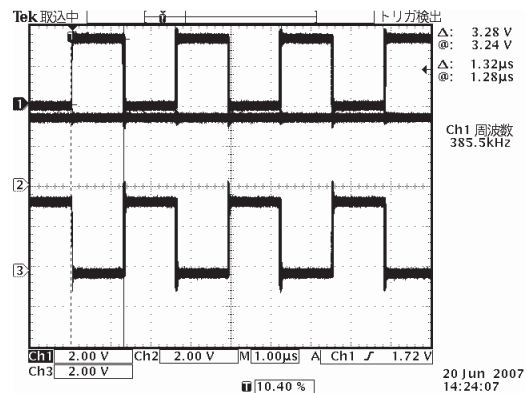

Waveform 2:PWM Signal (Pulse width changed by input signal)

CH1:IC206 4pin, IC206 14pin, IC207 2pin  
 CH2:IC206 5pin, IC206 15pin, IC207 4pin  
 CH3:IC206 6pin, IC206 16pin, IC207 1pin

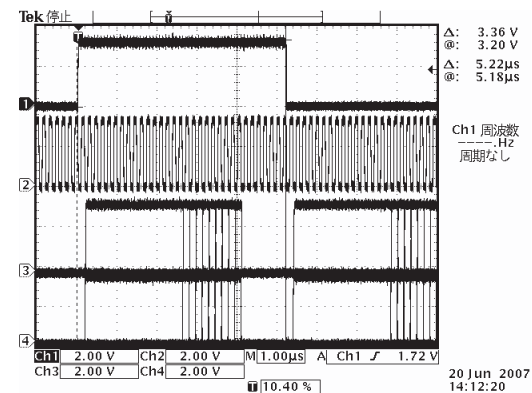

Waveform 5: A/D Waveform 2(Magnification)

CH1:IC201 24pin  
 CH2:IC201 23pin  
 CH3:IC201 21pin  
 CH4:IC201 19pin

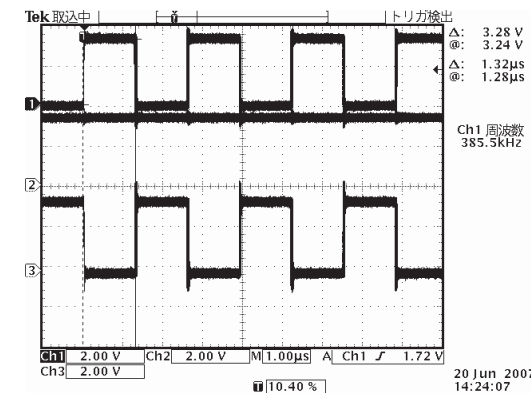

波形2:PWM信号 (パルス幅は入力信号により変化します。)

CH1:IC206 4pin, IC206 14pin, IC207 2pin  
 CH2:IC206 5pin, IC206 15pin, IC207 4pin  
 CH3:IC206 6pin, IC206 16pin, IC207 1pin

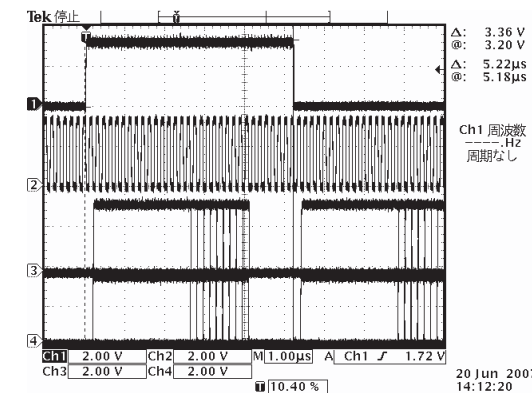

波形5: A/D波形 2(拡大)

CH1:IC201 24pin  
 CH2:IC201 23pin  
 CH3:IC201 21pin  
 CH4:IC201 19pin

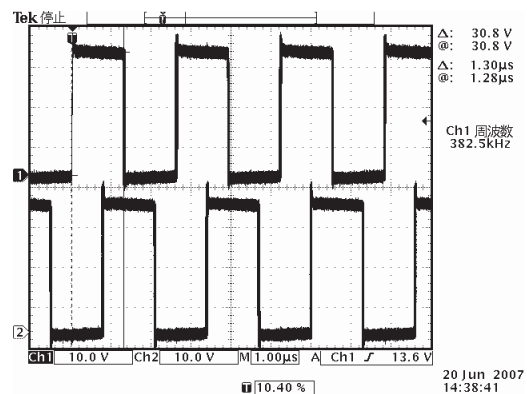

Waveform 3:Digital amp carrier Waveform

CH1:IC206 33pin, IC206 26pin, IC206 29pin  
 CH2:IC206 30pin, IC206 22pin, IC206 25pin

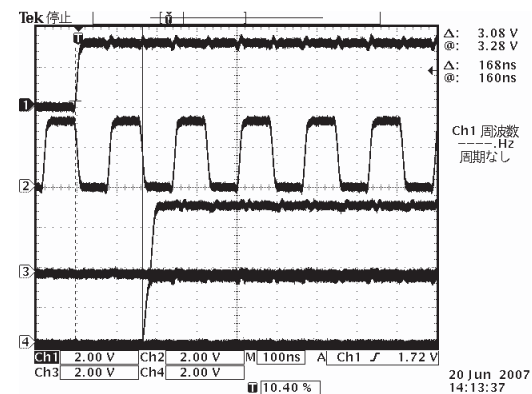

Waveform 6: A/D Waveform 3(Magnification)

CH1:IC201 24pin  
 CH2:IC201 23pin  
 CH3:IC201 21pin  
 CH4:IC201 19pin

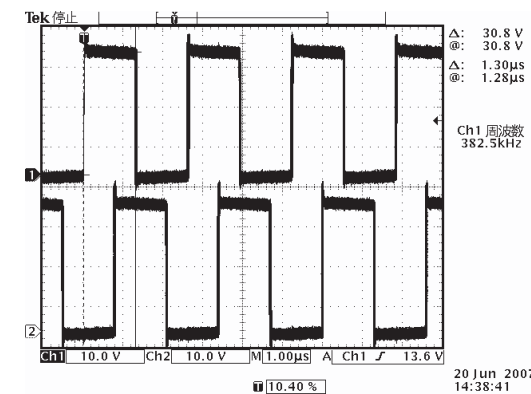

波形3:デジタルアンプキャリア波形

CH1:IC206 33pin, IC206 26pin, IC206 29pin  
 CH2:IC206 30pin, IC206 22pin, IC206 25pin

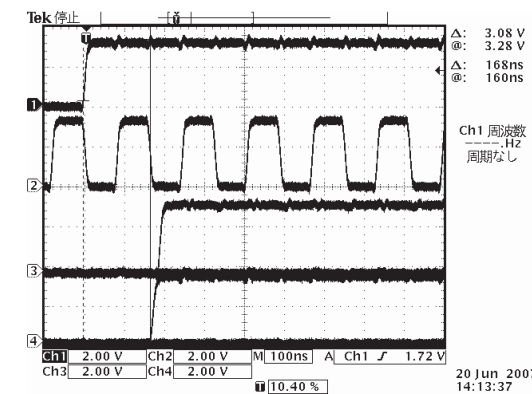

波形6: A/D波形 3(拡大)

CH1:IC201 24pin  
 CH2:IC201 23pin  
 CH3:IC201 21pin  
 CH4:IC201 19pin

## (3) POWER SUPPLY

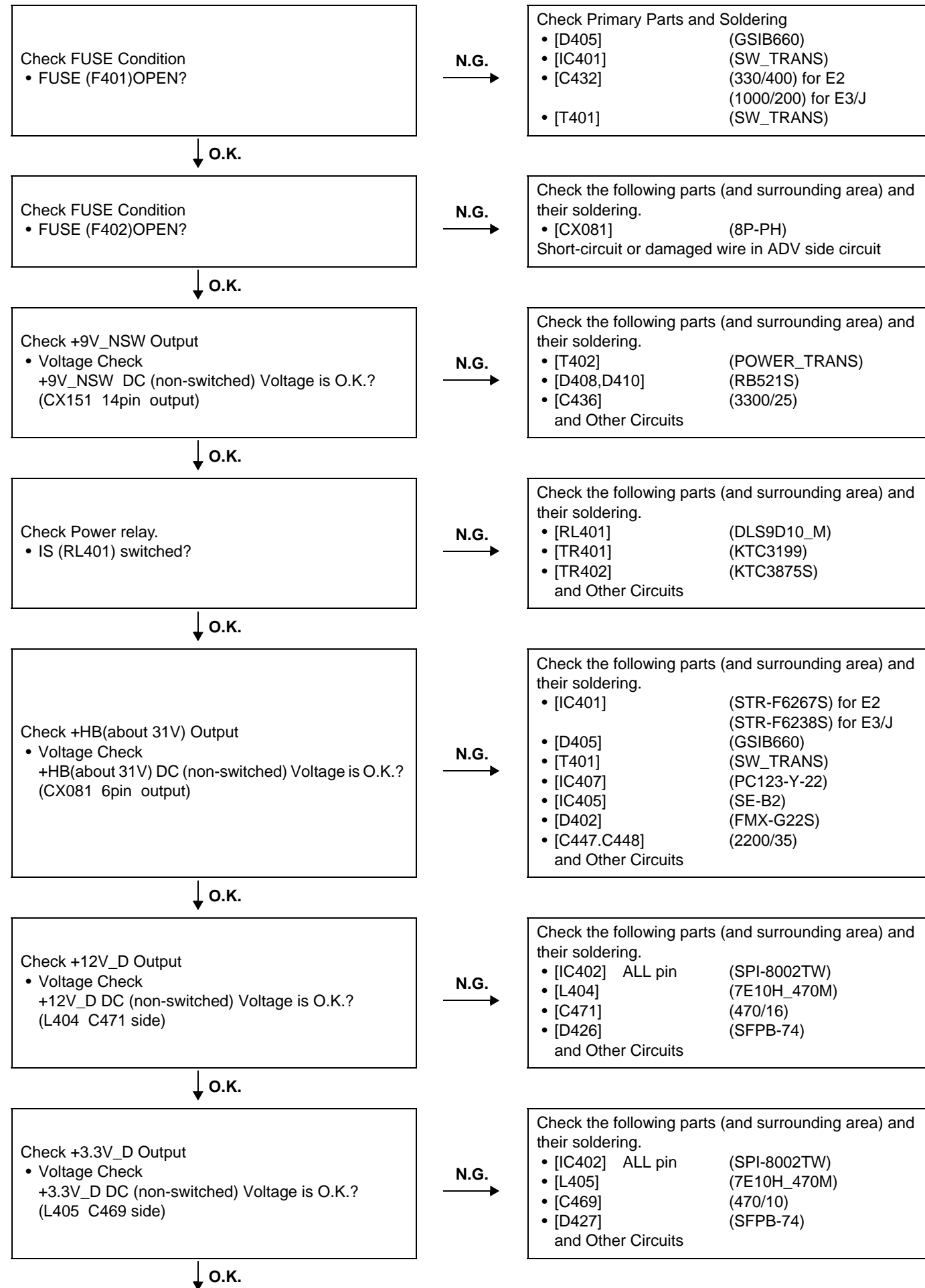

## (3) 電源

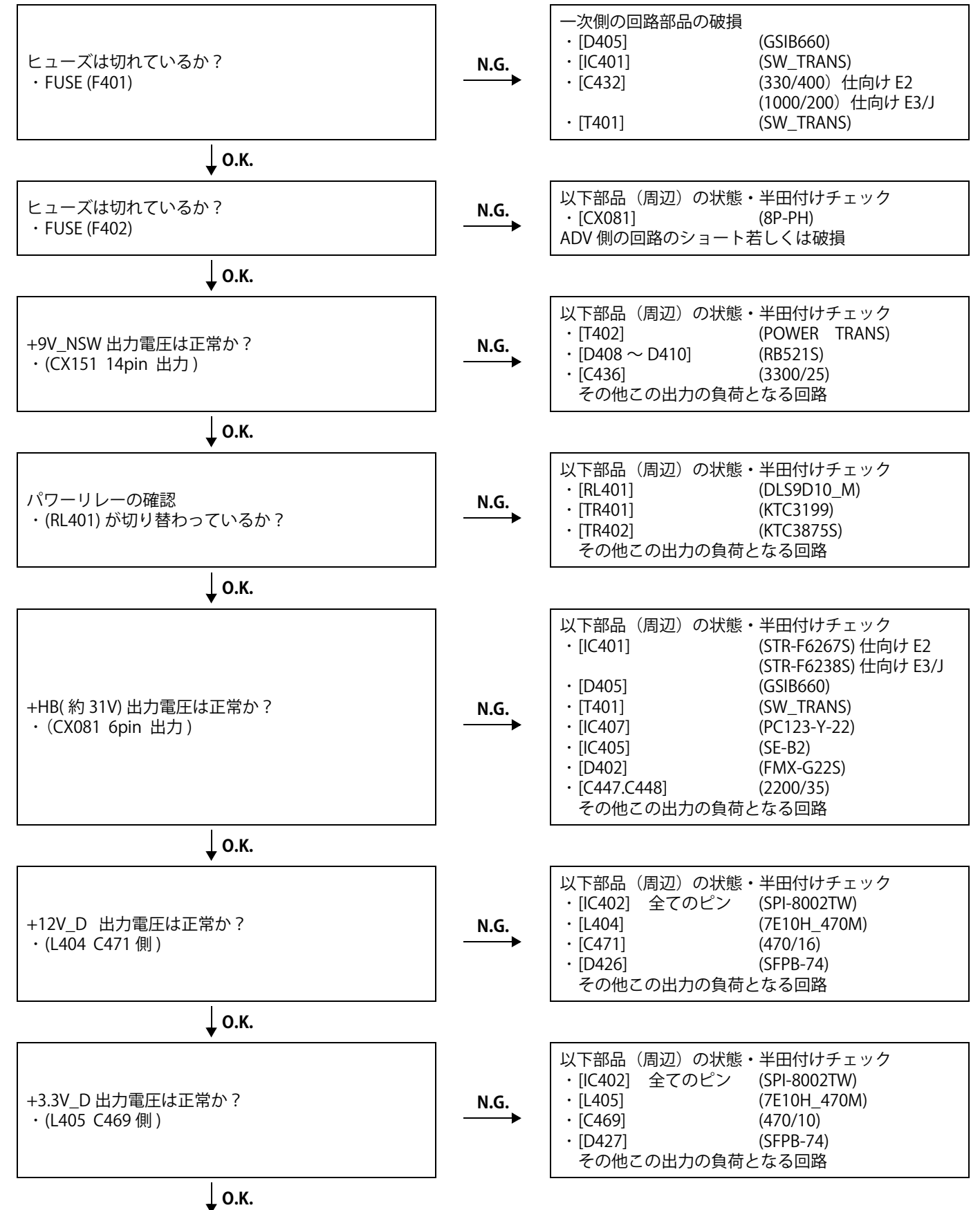

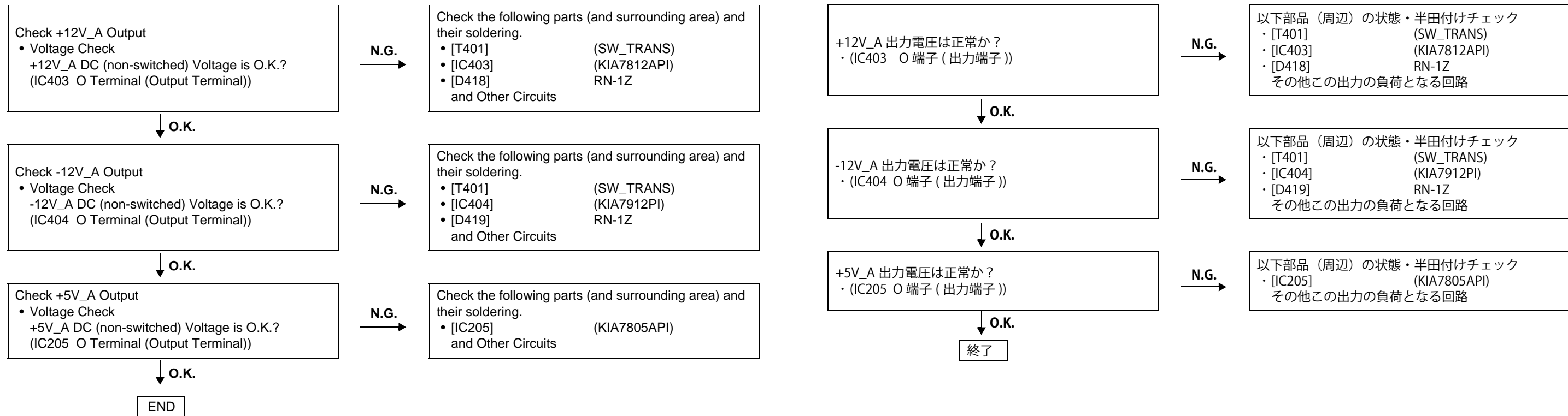

## ELECTRICAL ADJUSTMENT FOR VIDEO

### 1. SETTING

- (1) Connect the monitor TV to the video output terminal.
- (2) Connect the oscilloscope to the Y-signal and C-signal of S-VIDEO output terminal and each terminate at 75 Ohms.
- (3) Connect the oscilloscope to the Y-signal, PB-signal and PR-signal of Component video output terminal and each terminate at 75 Ohms.  
※ Use the 75 Ohms resistance must be 1%
- (4) DVD test disc : VT502

### 2. BEFORE ADJUSTMENT

#### 2.1. Setting the Oscilloscope as below.

- (1) PB/PR
  - (a) TIME/DIV : 20 $\mu$ S
  - (b) VOLT/DIV : 100mV
 (Use the probe : x10 )
- (2) Y
  - (a) TIME/DIV : 20 $\mu$ S
  - (b) VOLT/DIV : 200mV
 (Use the probe : x10 )
- (3) C
  - (a) TIME/DIV : 20 $\mu$ S
  - (b) VOLT/DIV : 50mV
 (Use the probe : x10 )

Power on. Power Supply

U.S.A. & Canada	:	120V
Europe & Asia	:	230V
China	:	220V
Japan	:	100V

#### 2.2. Preparation

- (1) Power on.
- (2) Check the Component output signal is progressive. ("PROGRESSIVE" is shown on the FL display)
- (3) Check the HDMI output is off. ("HDMI" is not shown on the FL display)
- (4) Push [▲] button, then open the Disc Tray. Set DVD test disc (VT502) on the Disc Tray, and then push [▲] button.
- (5) FL display appear "STOP", push [▶] button to playback DVD.
- (6) Press the remote control unit [CALL] button twice to display the title number.
- (7) Press the remote control unit [▶] cursor button to select the title number to be played.
- (8) Push the [3] button, select title 3 of DVD.
- (9) Push the [ENTER] button, playback title 3. (color bar 100%)

## ビデオ回路の調整

### 1. セッティング手順

- (1) セットの VIDEO OUT 端子にテレビモニターを接続する。
- (2) セットの S2 VIDEO OUT 端子から Y 信号と C 信号をそれぞれオシロスコープ (終端抵抗 : 75 $\Omega$ ) に接続する。
- (3) セットの COMPONENT VIDEO OUT の端子 (Y/PB/PR) をそれぞれオシロスコープ (終端抵抗 : 75 $\Omega$ ) に接続する。  
※ 75 $\Omega$  抵抗は 1%品を使用する事。
- (4) DVD テストディスク : VT502 を用意する。

### 2. 調整のまえに

#### 2.1. オシロスコープを下記に設定する。

- (1) PB/PR
  - (a) TIME/DIV : 20 $\mu$ S
  - (b) VOLT/DIV : 100mV  
(プローブ x10 使用)
- (2) Y
  - (a) TIME/DIV : 20 $\mu$ S
  - (b) VOLT/DIV : 200mV  
(プローブ x10 使用)
- (3) C
  - (a) TIME/DIV : 20 $\mu$ S
  - (b) VOLT/DIV : 50mV  
(プローブ x10 使用)
 電源電圧 : 100V (Japan)  
                   : 120V (U.S.A. & Canada)  
                   : 230V (Europe & Asia)  
                   : 220V (China)

#### 2.2. 準備手順

- (1) セットの AC コードをコンセントへ挿入し、セットの電源を ON する。
- (2) セットの COMPONENT VIDEO OUT 端子の出力が PROGRESSIVE になっていることを確認する。(FL 管の "PROGRESSIVE" が点灯していること)
- (3) HDMI 出力が OFF になっていることを確認する。(FL 管の "HDMI" が消灯していること)
- (4) セットの「▲」ボタンを押しトレイを開き、トレイ上に DVD テストディスク (VT502) をセット後、「▲」ボタンを押す。
- (5) セット表示管上に "STOP" が表示されてから、「▶」ボタンを押し、ディスクを再生する。
- (6) リモコンの「CALL」ボタンを 2 回押し、Title ナンバーを表示する。
- (7) リモコンのカーソル「▶」ボタンを押して、Title ナンバーを選択する。
- (8) 番号ボタンの [3] ボタンを押し、Title 3 を選択する。
- (9) 「ENTER」ボタンを押し、Title 3 を再生する (100%カラーバー信号)。

### 3. PROCEDURE

(1) Adjust the signal of S-VIDEO out by the wave of oscilloscope.

(a) Target, Y-signal

Point : VR504  
 Adjustment Value :  $1000 \pm 20\text{mV}$   
 Waveform

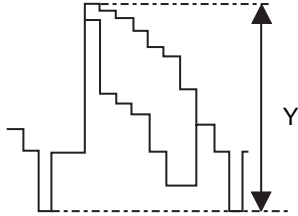

Y-signal of S-VIDEO out

(b) Target, C-signal

Point : VR505  
 Check Value :  $286 \pm 10\text{mV}$   
 Waveform

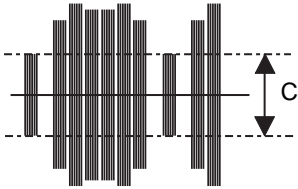

C-signal of S-VIDEO out

(2) Adjust the signal of COMPONENT OUT (PROGRESSIVE) by the wave of oscilloscope.

(a) Target, Y-signal

Point : VR501  
 Adjustment Value :  $1000 \pm 20\text{mV}$   
 Waveform

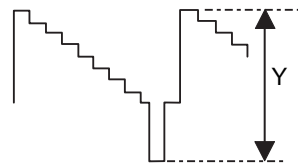

Y-signal

(b) Target, Pb-signal

Point : VR502  
 Check Value :  $*700 \pm 10\text{mV}$   
 Waveform

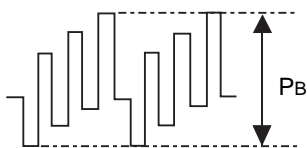

Pb-signal

### 3. 手順

(1) セットの S2 VIDEO OUT の信号レベルをオシロスコープ上の波高値で調整する。

(a) Y 信号レベル

調整箇所 : VR504  
 調整値 :  $1000 \pm 20\text{mV}$   
 波形

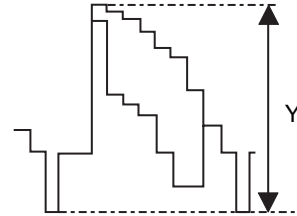

S2 VIDEO OUT の Y 信号レベル

(b) C 信号レベル

調整箇所 : VR505  
 確認 :  $286 \pm 10\text{mV}$   
 波形

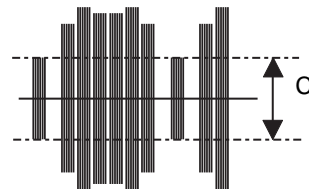

S2 VIDEO OUT の C 信号レベル

(2) COMPONENT OUT (PROGRESSIVE) の信号レベルをオシロスコープ上の波高値で調整する。

(a) Y 信号レベル

調整箇所 : VR501  
 調整値 :  $1000 \pm 20\text{mV}$   
 波形

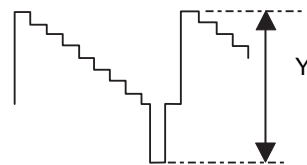

プログレッシブの Y 信号レベル

(b) Pb 信号レベル

調整箇所 : VR502  
 確認 :  $*700 \pm 10\text{mV}$   
 波形

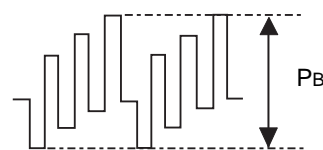

Pb 信号レベル

(c) Target, PR-signal

Point : VR503  
Check Value :  $700 \pm 10\text{mV}$   
Waveform

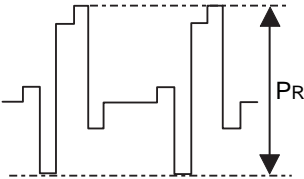

PR-signal

⚠ Deletion of comment

(c) PR 信号レベル

調整個所 : VR503  
調整値 :  $700 \pm 10\text{mV}$   
波形

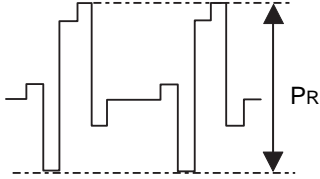

PR 信号レベル

⚠ コメント削除

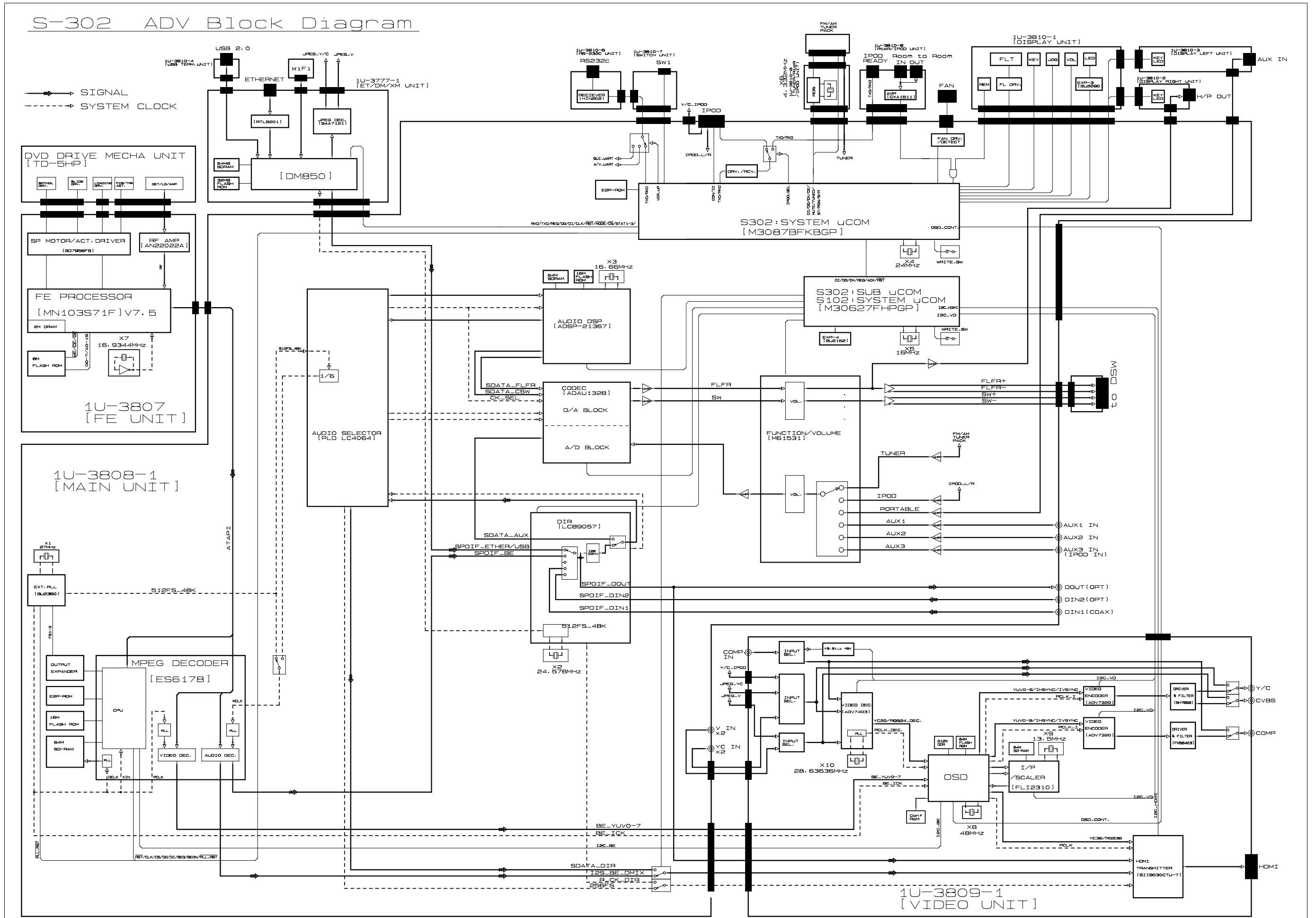



DSW-S302

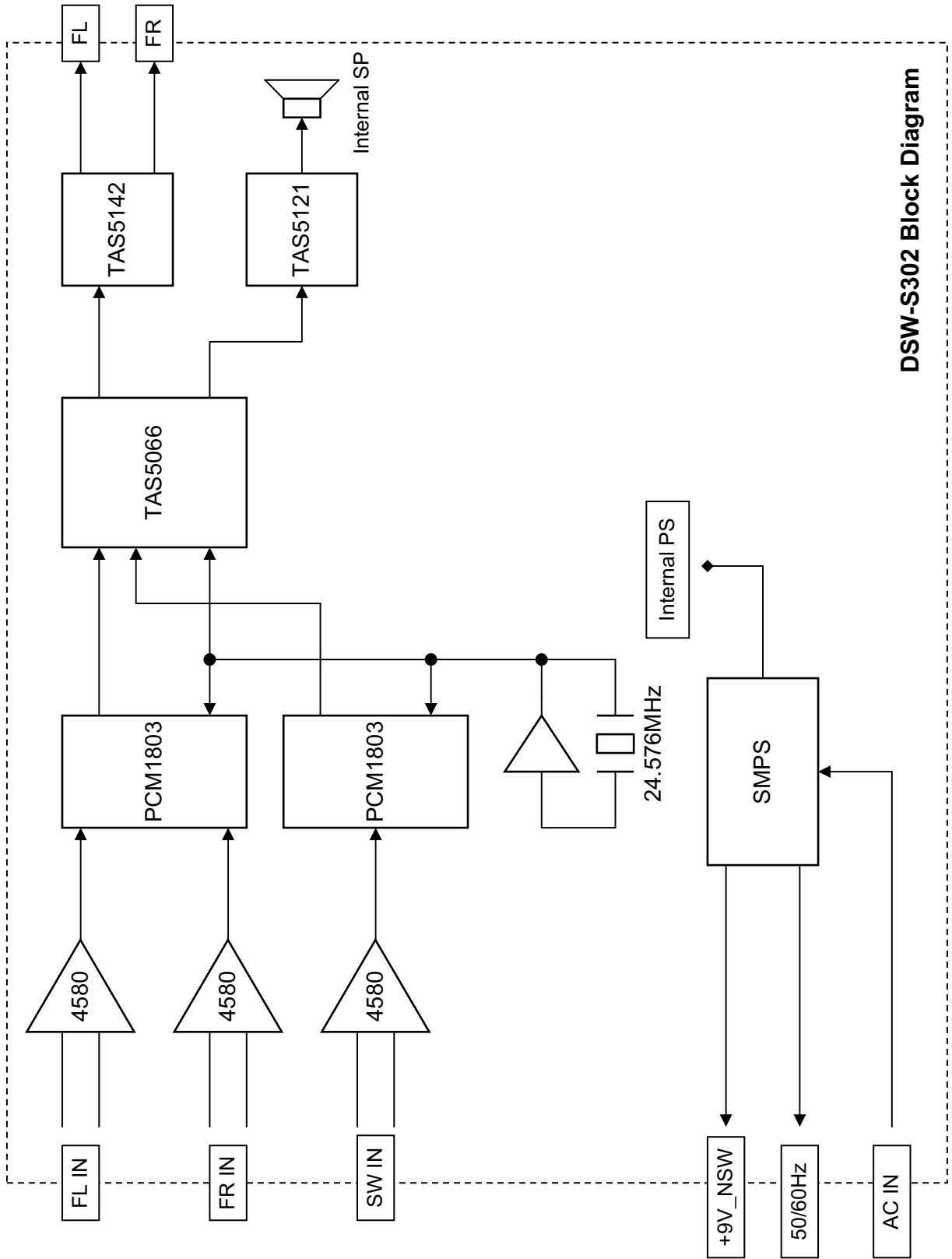

DSW-S302 Block Diagram

# LEVEL DIAGRAM

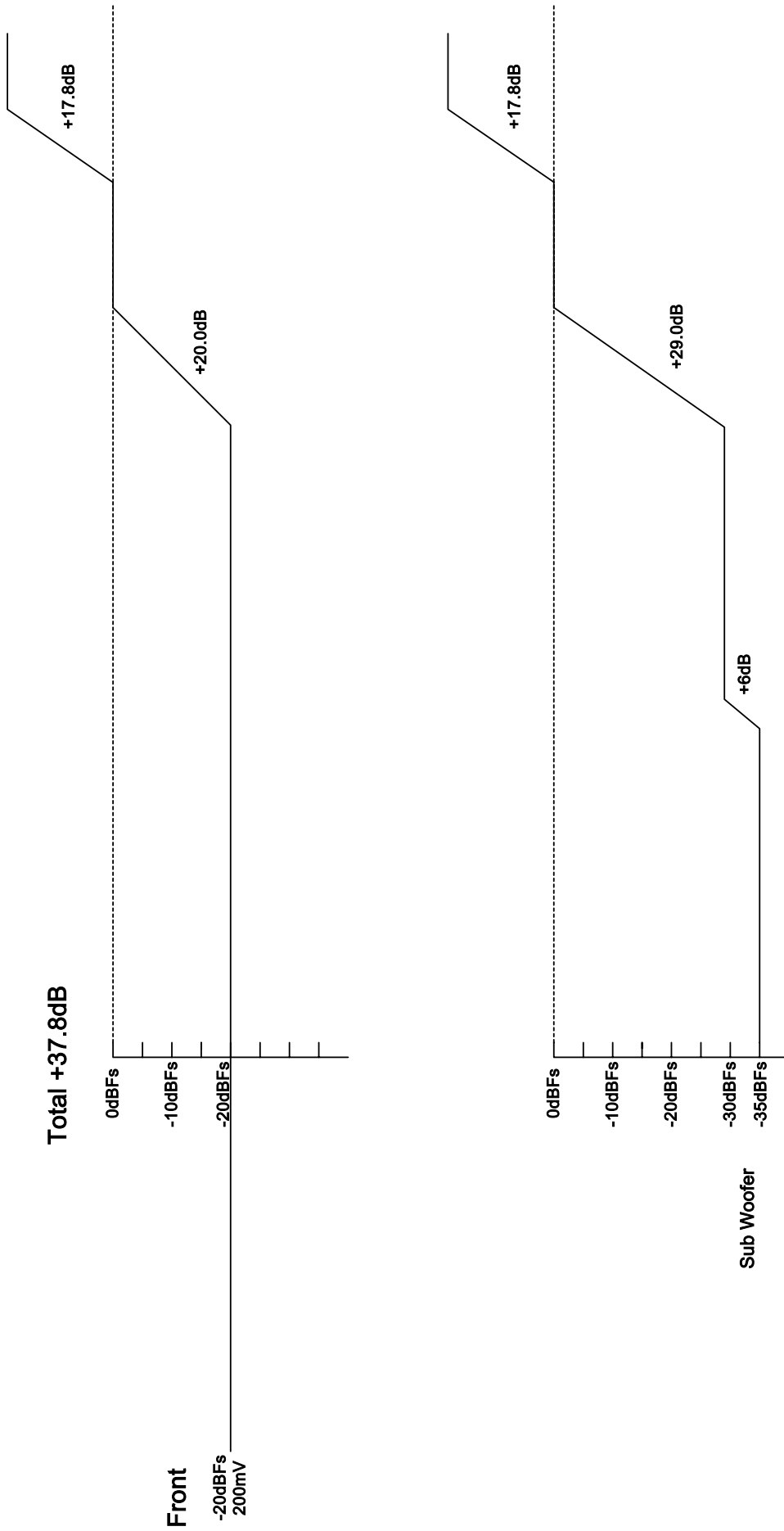

# SEMICONDUCTORS

Only major semiconductors are shown, general semiconductors etc. are omitted to list.  
主な半導体を記載しています。汎用の半導体は記載を省略しています。

## 1. IC's

### ES6178FF (IC101: 1U-3808) PINOUT DIAGRAM

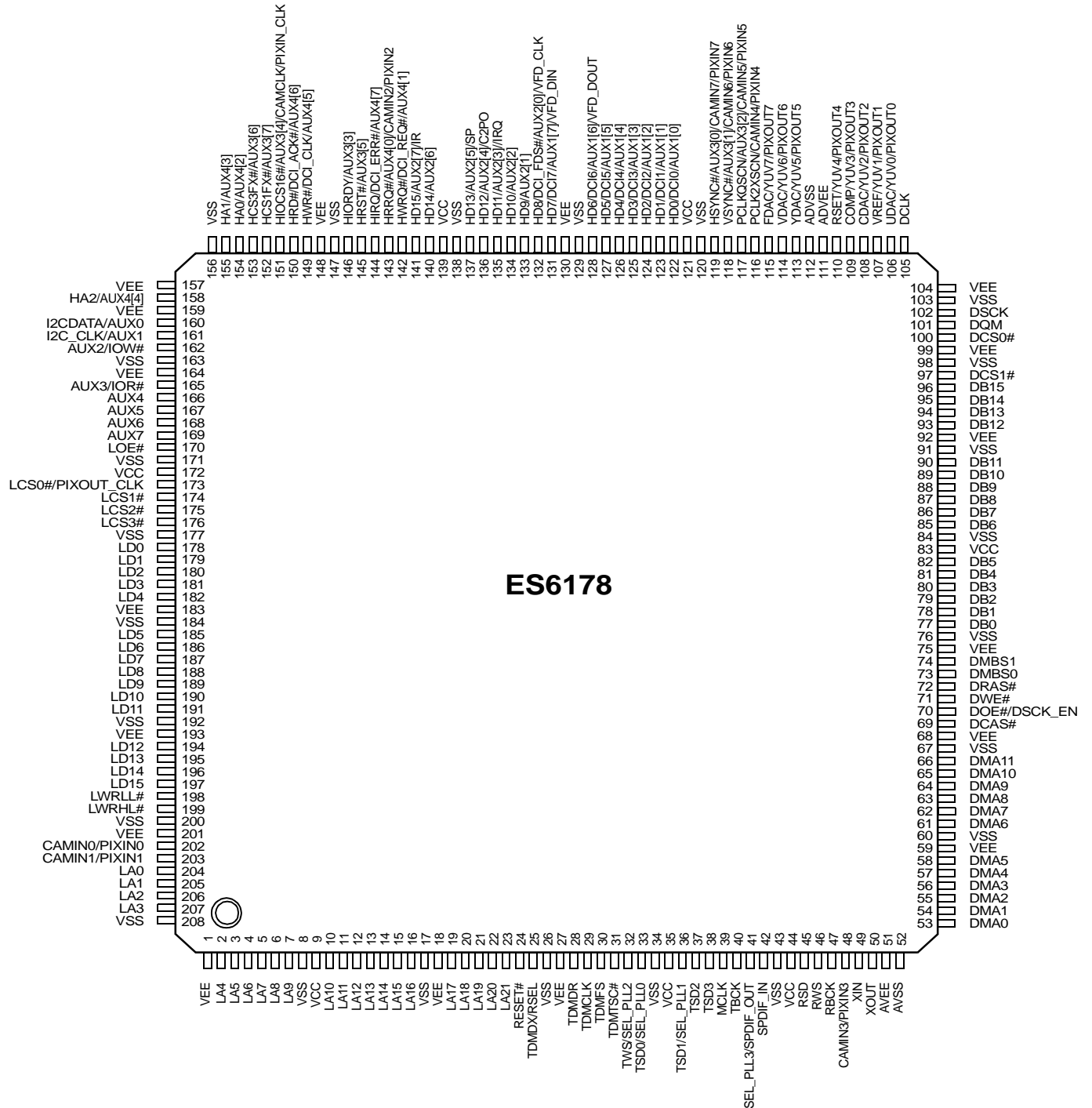

## ES6178FF PIN DESCRIPTION

Name	Pin Numbers	I/O	Definition																																			
VEE	1,18, 27, 59, 68, 75, 92, 99, 104, 130, 148, 157, 159, 164, 183, 193, 201	P	I/O power supply.																																			
LA[21:0]	2-7, 10-16, 19-23, 204-207	O	RISC port address bus.																																			
VSS	8, 17, 26, 34, 43, 60, 67, 76, 84, 91, 98, 103, 120, 129, 138, 147, 156, 163, 171, 177, 184, 192, 200, 208	G	Ground.																																			
VCC	9, 35, 44, 83, 121, 139, 172	P	Core power supply.																																			
RESET#	24	I	Reset input; (5V tolerant input).																																			
TDMDX	25	O	TDM transmit data output.																																			
RSEL		I	LCS3 ROM Boot Data Width Select. Strapped to VCC or ground via 4.7-k $\Omega$ resistor; read only during reset. <table border="1" data-bbox="708 887 1050 1025"> <thead> <tr> <th>RSEL</th> <th>Selection</th> </tr> </thead> <tbody> <tr> <td>0</td> <td>16-bit ROM</td> </tr> <tr> <td>1</td> <td>8-bit ROM</td> </tr> </tbody> </table>	RSEL	Selection	0	16-bit ROM	1	8-bit ROM																													
RSEL	Selection																																					
0	16-bit ROM																																					
1	8-bit ROM																																					
TDMDR	28	I	TDM receive data input; (5V tolerant input).																																			
TDMCLK	29	I	TDM clock input; (5V tolerant input).																																			
TDMFS	30	I	TDM frame sync input; (5V tolerant input).																																			
TDMTSC#	31	O	TDM output enable.																																			
TWS	32	O	Audio transmit frame sync output.																																			
SEL_PLL2		I	System and DSCK output clock frequency selection is made at the rising edge of RESET#. The matrix below lists the available clock frequencies and their respective PLL bit settings. Strapped to VCC or ground via 4.7-k $\Omega$ resistor; read only during reset. <table border="1" data-bbox="695 1413 1374 1738"> <thead> <tr> <th>SEL_PLL2</th> <th>SEL_PLL1</th> <th>SEL_PLL0</th> <th>PLL Settings</th> </tr> </thead> <tbody> <tr> <td>0</td> <td>0</td> <td>0</td> <td>DCLK <math>\times</math> 4.5</td> </tr> <tr> <td>0</td> <td>0</td> <td>1</td> <td>DCLK <math>\times</math> 5.0</td> </tr> <tr> <td>0</td> <td>1</td> <td>0</td> <td>Bypass</td> </tr> <tr> <td>0</td> <td>1</td> <td>1</td> <td>DCLK <math>\times</math> 4.0</td> </tr> <tr> <td>1</td> <td>0</td> <td>0</td> <td>DCLK <math>\times</math> 4.25</td> </tr> <tr> <td>1</td> <td>0</td> <td>1</td> <td>DCLK <math>\times</math> 4.75</td> </tr> <tr> <td>1</td> <td>1</td> <td>0</td> <td>DCLK <math>\times</math> 5.5</td> </tr> <tr> <td>1</td> <td>1</td> <td>1</td> <td>DCLK <math>\times</math> 6.0</td> </tr> </tbody> </table>	SEL_PLL2	SEL_PLL1	SEL_PLL0	PLL Settings	0	0	0	DCLK $\times$ 4.5	0	0	1	DCLK $\times$ 5.0	0	1	0	Bypass	0	1	1	DCLK $\times$ 4.0	1	0	0	DCLK $\times$ 4.25	1	0	1	DCLK $\times$ 4.75	1	1	0	DCLK $\times$ 5.5	1	1	1
SEL_PLL2	SEL_PLL1	SEL_PLL0	PLL Settings																																			
0	0	0	DCLK $\times$ 4.5																																			
0	0	1	DCLK $\times$ 5.0																																			
0	1	0	Bypass																																			
0	1	1	DCLK $\times$ 4.0																																			
1	0	0	DCLK $\times$ 4.25																																			
1	0	1	DCLK $\times$ 4.75																																			
1	1	0	DCLK $\times$ 5.5																																			
1	1	1	DCLK $\times$ 6.0																																			

Name	Pin Numbers	I/O	Definition						
TSD0	33	O	Audio transmit serial data output 0.						
SEL_PLL0		I	Refer to the description and matrix for SEL_PLL2 pin 32.						
TSD1	36	O	Audio transmit serial data output 1.						
SEL_PLL1		I	Refer to the description and matrix for SEL_PLL2 pin 32.						
TSD2	37	O	Audio transmit serial data output 2. This pin must be pulled down to VSS via a 4.7-k $\Omega$ resistor for proper operation.						
TSD3	38	O	Audio transmit serial data output 3.						
MCLK	39	I/O	Audio master clock for audio DAC.						
TBCK	40	I/O	Audio transmit bit clock. TBCK is an input during reset and subsequently is programmed as an output via the AUDIOXMT register (addr 0x2000D00Ch, bit 4).						
SEL_PLL3	41	I	Clock source select. Strapped to VCC or ground via 4.7-k $\Omega$ resistor; read only during reset. <table border="1" data-bbox="694 728 1120 869"> <thead> <tr> <th>SEL_PLL3</th> <th>Clock Source</th> </tr> </thead> <tbody> <tr> <td>0</td> <td>Crystal oscillator</td> </tr> <tr> <td>1</td> <td>DCLK input</td> </tr> </tbody> </table>	SEL_PLL3	Clock Source	0	Crystal oscillator	1	DCLK input
SEL_PLL3		Clock Source							
0	Crystal oscillator								
1	DCLK input								
SPDIF_OUT		O	S/PDIF output.						
SPDIF_IN	42	I	S/PDIF input; (5V tolerant input).						
RSD	45	I	Audio receive serial data; (5V tolerant input).						
RWS	46	I	Audio receive frame sync; (5V tolerant input).						
RBCK	47	I	Audio receive bit clock; (5V tolerant input).						
CAMIN3	48	I	Camera YUV 3.						
PIXIN3		I	CCIR656 input pixel 3.						
XIN	49	I	27-MHz crystal input.						
XOUT	50	O	27-MHz crystal output.						
AVEE	51	P	Analog power for PLL.						
AVSS	52	G	Analog ground for PLL.						
DMA[11:0]	53-58, 61-66	O	DRAM address bus.						
DCAS#	69	O	DRAM column address strobe.						
DOE#	70	O	DRAM output enable.						
DSCK_EN		O	DRAM clock enable.						
DWE#	71	O	DRAM write enable.						
DRAS#	72	O	DRAM row address strobe.						
DMBS0	73	O	DRAM bank select 0.						
DMBS1	74	O	DRAM bank select 1.						
DB[15:0]	77-82, 85-90, 93-96	I/O	DRAM data bus.						
DCS[1:0]#	97,100	O	DRAM chip select.						
DQM	101	O	Data input/output mask.						
DSCK	102	O	Output clock to DRAM.						

Name	Pin Numbers	I/O	Definition																																																																																																
DCLK	105	I	Clock input to PLL; (5V tolerant input).																																																																																																
UDAC	106	O	Video DAC output. <table border="1" data-bbox="694 336 1444 1108"> <thead> <tr> <th>Value</th> <th>F DAC (pin 115)</th> <th>V DAC (pin 114)</th> <th>Y DAC (pin 113)</th> <th>C DAC (pin 108)</th> <th>U DAC (pin 106)</th> </tr> </thead> <tbody> <tr><td>0</td><td>CVBS/Chroma</td><td>CVBS1</td><td>Y</td><td>C</td><td>N/A</td></tr> <tr><td>1</td><td>CVBS/Chroma</td><td>CVBS1</td><td>Y</td><td>C</td><td>CVBS2</td></tr> <tr><td>2</td><td>CVBS/Chroma</td><td>N/A</td><td>Y</td><td>C</td><td>N/A</td></tr> <tr><td>3</td><td>CVBS/Chroma</td><td>CVBS1</td><td>N/A</td><td>N/A</td><td>CVBS2</td></tr> <tr><td>4</td><td>CVBS/Chroma</td><td>CVBS1</td><td>N/A</td><td>N/A</td><td>N/A</td></tr> <tr><td>5</td><td>CVBS/Chroma</td><td>CVBS1</td><td>Y</td><td>Pb</td><td>Pr</td></tr> <tr><td>6</td><td>CVBS/Chroma</td><td>N/A</td><td>Y</td><td>Pb</td><td>Pr</td></tr> <tr><td>7</td><td>N/A</td><td>SYNC</td><td>G</td><td>B</td><td>R</td></tr> <tr><td>8</td><td>CVBS/Chroma</td><td>Chroma</td><td>Y</td><td>Pb</td><td>Pr</td></tr> <tr><td>9</td><td>CVBS</td><td>CVBS1</td><td>G</td><td>B</td><td>R</td></tr> <tr><td>10</td><td>CVBS</td><td>CVBS1</td><td>G</td><td>R</td><td>B</td></tr> <tr><td>11</td><td>N/A</td><td>SYNC</td><td>G</td><td>R</td><td>B</td></tr> <tr><td>12</td><td>CVBS/Chroma</td><td>N/A</td><td>Y</td><td>Pr</td><td>Pb</td></tr> <tr><td>13</td><td>CVBS/Chroma</td><td>CVBS1</td><td>Y</td><td>Pr</td><td>Pb</td></tr> <tr><td>14</td><td>Chroma</td><td>Y</td><td>G</td><td>R</td><td>B</td></tr> </tbody> </table> <p>F: CVBS/chroma signal for simultaneous mode.  Y: Luma component for YUV and Y/C processing.  C: Chrominance signal for Y/C processing.  U: Chrominance component signal for YUV mode.  V: Chrominance component signal for YUV mode.</p>	Value	F DAC (pin 115)	V DAC (pin 114)	Y DAC (pin 113)	C DAC (pin 108)	U DAC (pin 106)	0	CVBS/Chroma	CVBS1	Y	C	N/A	1	CVBS/Chroma	CVBS1	Y	C	CVBS2	2	CVBS/Chroma	N/A	Y	C	N/A	3	CVBS/Chroma	CVBS1	N/A	N/A	CVBS2	4	CVBS/Chroma	CVBS1	N/A	N/A	N/A	5	CVBS/Chroma	CVBS1	Y	Pb	Pr	6	CVBS/Chroma	N/A	Y	Pb	Pr	7	N/A	SYNC	G	B	R	8	CVBS/Chroma	Chroma	Y	Pb	Pr	9	CVBS	CVBS1	G	B	R	10	CVBS	CVBS1	G	R	B	11	N/A	SYNC	G	R	B	12	CVBS/Chroma	N/A	Y	Pr	Pb	13	CVBS/Chroma	CVBS1	Y	Pr	Pb	14	Chroma	Y	G	R	B
Value		F DAC (pin 115)	V DAC (pin 114)	Y DAC (pin 113)	C DAC (pin 108)	U DAC (pin 106)																																																																																													
0		CVBS/Chroma	CVBS1	Y	C	N/A																																																																																													
1		CVBS/Chroma	CVBS1	Y	C	CVBS2																																																																																													
2		CVBS/Chroma	N/A	Y	C	N/A																																																																																													
3		CVBS/Chroma	CVBS1	N/A	N/A	CVBS2																																																																																													
4		CVBS/Chroma	CVBS1	N/A	N/A	N/A																																																																																													
5		CVBS/Chroma	CVBS1	Y	Pb	Pr																																																																																													
6		CVBS/Chroma	N/A	Y	Pb	Pr																																																																																													
7		N/A	SYNC	G	B	R																																																																																													
8		CVBS/Chroma	Chroma	Y	Pb	Pr																																																																																													
9		CVBS	CVBS1	G	B	R																																																																																													
10		CVBS	CVBS1	G	R	B																																																																																													
11		N/A	SYNC	G	R	B																																																																																													
12		CVBS/Chroma	N/A	Y	Pr	Pb																																																																																													
13	CVBS/Chroma	CVBS1	Y	Pr	Pb																																																																																														
14	Chroma	Y	G	R	B																																																																																														
YUV0		O	YUV pixel 0 output data.																																																																																																
PIXOUT0		O	CCIR656 output pixel 0.																																																																																																
VREF	107	I	Internal voltage reference to video DAC. Bypass to ground with 0.1- $\mu$ F capacitor.																																																																																																
YUV1		O	YUV pixel 1 output data.																																																																																																
PIXOUT1		O	CCIR656 output pixel 1.																																																																																																
CDAC	108	O	Video DAC output. Refer to description and matrix for UDAC pin 106.																																																																																																
YUV2		O	YUV pixel 2 output data.																																																																																																
PIXOUT2		O	CCIR656 output pixel 2.																																																																																																
COMP	109	I	Compensation input. Bypass to ADVEE with 0.1- $\mu$ F capacitor.																																																																																																
YUV3		O	YUV pixel 3 output data.																																																																																																
PIXOUT3		O	CCIR656 output pixel 3.																																																																																																
RSET	110	I	DAC current adjustment resistor input.																																																																																																
YUV4		O	YUV pixel 4 output data.																																																																																																
PIXOUT4		O	CCIR656 output pixel 4.																																																																																																

Name	Pin Numbers	I/O	Definition
ADVEE	111	P	Analog power for video DAC.
ADVSS	112	G	Analog ground for video DAC.
YDAC	113	O	Video DAC output. Refer to description and matrix for UDAC pin 106.
YUV5		O	YUV pixel 5 output data
PIXOUT5		O	CCIR656 output pixel 5.
VDAC	114	O	Video DAC output. Refer to description and matrix for UDAC pin 106.
YUV6		O	YUV pixel 6 output data.
PIXOUT6		O	CCIR656 output pixel 6.
FDAC	115	O	Video DAC output. Refer to description and matrix for UDAC pin 106.
YUV7		O	YUV pixel 7 output data.
PIXOUT7		O	CCIR656 output pixel 7.
PCLK2XSCN	116	I/O	27-MHz video output pixel clock.
CAMIN4		I	Camera YUV 4.
PIXIN4		I	CCIR656 input pixel 4.
PCLKQSCN	117	O	13.5-MHz video output pixel clock.
AUX3[2]		I/O	Aux3 data I/O; (5V tolerant input).
CAMIN5		I	Camera YUV 5.
PIXIN5		I	CCIR656 input pixel 5.
VSYNC#	118	I/O	Vertical sync; (5V tolerant input).
AUX3[1]		I/O	Aux3 data I/O; (5V tolerant input).
CAMIN6		I	Camera YUV 6.
PIXIN6		I	CCIR656 input pixel 6.
HSYNC#	119	I/O	Horizontal sync; (5V tolerant input).
AUX3[0]		I/O	Aux3 data I/O; (5V tolerant input).
CAMIN7		I	Camera YUV 7.
PIXIN7		I	CCIR656 input pixel 7.
HD[5:0]	122-127	I/O	Host data bus lines; (5V tolerant input).
DCI[5:0]		I/O	DVD channel data I/O; (5V tolerant input).
AUX1[5:0]		I/O	Aux1 data I/O; (5V tolerant input).
HD6	128	I/O	Host data bus line; (5V tolerant input).
DCI6		I/O	DVD channel data I/O; (5V tolerant input).
AUX1[6]		I/O	Aux1 data I/O; (5V tolerant input).
VFD_DOUT		I	VFD data output.
HD7	131	I/O	Host data bus line; (5V tolerant input).
DCI7		I/O	DVD channel data I/O; (5V tolerant input).
AUX1[7]		I/O	Aux1 data I/O; (5V tolerant input).
VFD_DIN		I	VFD data input.

Name	Pin Numbers	I/O	Definition
HD8	132	I/O	Host data bus line; (5V tolerant input).
DCI_FDS#		I/O	DVD input sector start; (5V tolerant input).
AUX2[0]		I/O	Aux2 data I/O; (5V tolerant input).
VFD_CLK		I	VFD clock input.
HD9	133	I/O	Host data bus line; (5V tolerant input).
AUX2[1]		I/O	Aux2 data I/O; (5V tolerant input).
HD10	134	I/O	Host data bus line; (5V tolerant input).
AUX2[2]		I/O	Aux2 data I/O; (5V tolerant input).
HD11	135	I/O	Host data bus line; (5V tolerant input).
AUX2[3]		I/O	Aux2 data I/O; (5V tolerant input).
IRQ		O	IRQ.
HD12	136	I/O	Host data bus line; (5V tolerant input).
AUX2[4]		I/O	Aux2 data I/O; (5V tolerant input).
C2PO		I	C2PO error correction flag from CD-ROM; (5V tolerant input).
HD13	137	I/O	Host data bus line; (5V tolerant input).
AUX2[5]		I/O	Aux2 data I/O; (5V tolerant input).
SP		I	16550 UART serial port input.
HD14	140	I/O	Host data bus line; (5V tolerant input).
AUX2[6]		I/O	Aux2 data I/O; (5V tolerant input).
HD15	141	I/O	Host data bus line; (5V tolerant input).
AUX2[7]		I/O	Aux2 data I/O; (5V tolerant input).
IR		I	IR remote control input; (5V tolerant input).
HWRQ#	142	O	Host write request.
DCI_REQ#		O	DVD control interface request.
AUX4[1]		I/O	Aux4 data I/O; (5V tolerant input).
HRRQ#	143	O	Host read request.
AUX4[0]		I/O	Aux4 data I/O; (5V tolerant input).
CAMIN2		I	Camera YUV 2.
PIXIN2		I	CCIR656 input pixel 2.
HIRQ	144	I/O	Host interrupt.
DCI_ERR#		I/O	DVD channel data error; (5V tolerant input).
AUX4[7]		I/O	Aux4 data I/O; (5V tolerant input).
HRST#	145	O	Host reset.
AUX3[5]		I/O	Aux3 data I/O; (5V tolerant input).
HIORDY	146	I	Host I/O ready.
AUX3[3]		I/O	Aux3 data I/O; (5V tolerant input).



Name	Pin Numbers	I/O	Definition
HWR#	149	I/O	Host write.
DCI_CLK		I/O	DVD channel data clock; (5V tolerant input).
AUX4[5]		I/O	Aux4 data I/O; (5V tolerant input).
HRD#	150	O	Host read.
DCI_ACK#		I/O	DVD channel data valid; (5V tolerant input).
AUX4[6]		I/O	Aux4 data I/O; (5V tolerant input).
HIOCS16#	151	I	Device 16-bit data transfer.
AUX3[4]		I/O	Aux3 data I/O; (5V tolerant input).
CAMCLK		I	Camera port pixel clock input.
PIXIN_CLK		I	CCIR656 input pixel clock.
HCS1FX#	152	O	Host select 1.
AUX3[7]		I/O	Aux3 data I/O; (5V tolerant input).
HCS3FX#	153	O	Host select 3.
AUX3[6]		I/O	Aux3 data I/O; (5V tolerant input).
HA[2:0]	154, 155, 158	I/O	Host address bus.
AUX4[4:2]		I/O	Aux4 data I/Os; (5V tolerant input).
AUX0	160	I/O	Auxiliary port 0 (open collector); (5V tolerant input).
I2CDATA		I/O	I <sup>2</sup> C data I/O; (5V tolerant input).
AUX1	161	I/O	Auxiliary port 1 (open collector); (5V tolerant input).
I2C_CLK		I/O	I <sup>2</sup> C clock I/O; (5V tolerant input).
AUX2	162	I/O	Auxiliary port; (5V tolerant input).
IOW#		O	I/O write strobe (LCS1).
AUX3	165	I/O	Auxiliary port; (5V tolerant input).
IOR#		O	I/O read strobe (LCS1).
AUX4-7	166-169	I/O	Auxiliary ports; (5V tolerant input).
LOE#	170	O	RISC port output enable.
LCS0#	173	O	RISC port chip select 0.
PIXOUT_CLK		O	CCIR656 output pixel clock.
LCS[3:1]#	174-176	O	RISC port chip select [3:1].
LD[15:0]	178-182, 185-191, 194-197	I/O	RISC port data bus; (5V tolerant input).
LWRL#	198	O	RISC port low-byte write enable.
LWRHL#	199	O	RISC port high-byte write enable.
CAMIN0	202	I	Camera YUV 0.
PIXIN0		I	CCIR656 input pixel 0.
CAMIN1	203	I	Camera YUV 1.
PIXIN1		I	CCIR656 input pixel 1.

BCOIC-DM850E-CQL (IC101: 1U-3777)

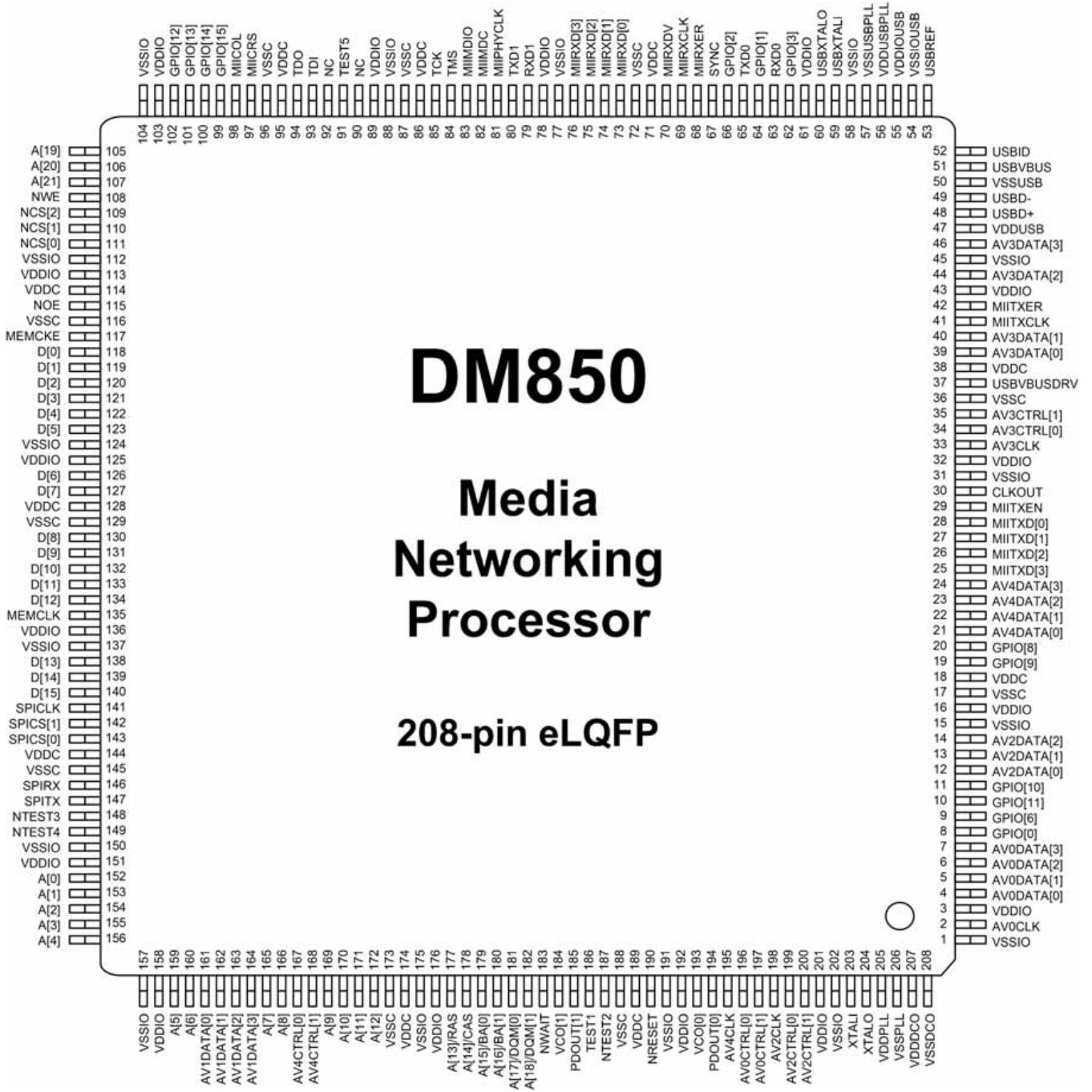

Pin	Name	Pin	Name	Pin	Name	Pin	Name
1	VSSIO	53	USBREF	105	A[19]	157	VSSIO
2	AV0CLK	54	VSSIOUSB	106	A[20]	158	VDDIO
3	VDDIO	55	VDDIOUSB	107	A[21]	159	A[5]
4	AV0DATA[0]	56	VDDUSBPLL	108	NWE	160	A[6]
5	AV0DATA[1]	57	VSSUSBPLL	109	NCS[2]	161	AV1DATA[0]
6	AV0DATA[2]	58	VSSIO	110	NCS[1]	162	AV1DATA[1]
7	AV0DATA[3]	59	USBXTALI	111	NCS[0]	163	AV1DATA[2]
8	GPIO[0]	60	USBXTALO	112	VSSIO	164	AV1DATA[3]
9	GPIO[6]	61	VDDIO	113	VDDIO	165	A[7]
10	GPIO[11]	62	GPIO[3]	114	VDDC	166	A[8]
11	GPIO[10]	63	RXD0	115	NOE	167	AV4CTRL[0]
12	AV2DATA[0]	64	GPIO[1]	116	VSSC	168	AV4CTRL[1]
13	AV2DATA[1]	65	TXD0	117	MEMCKE	169	A[9]
14	AV2DATA[2]	66	GPIO[2]	118	D[0]	170	A[10]
15	VSSIO	67	SYNC	119	D[1]	171	A[11]
16	VDDIO	68	MIIRXER	120	D[2]	172	A[12]
17	VSSC	69	MIIRXCLK	121	D[3]	173	VSSC
18	VDDC	70	MIIRXDV	122	D[4]	174	VDDC
19	GPIO[9]	71	VDDC	123	D[5]	175	VSSIO
20	GPIO[8]	72	VSSC	124	VSSIO	176	VDDIO
21	AV4DATA[0]	73	MIIRXD[0]	125	VDDIO	177	A[13]/RAS
22	AV4DATA[1]	74	MIIRXD[1]	126	D[6]	178	A[14]/CAS
23	AV4DATA[2]	75	MIIRXD[2]	127	D[7]	179	A[15]/BA[0]
24	AV4DATA[3]	76	MIIRXD[3]	128	VDDC	180	A[16]/BA[1]
25	MIITXD[3]	77	VSSIO	129	VSSC	181	A[17]/DQM[0]
26	MIITXD[2]	78	VDDIO	130	D[8]	182	A[18]/DQM[1]
27	MIITXD[1]	79	RXD1	131	D[9]	183	NWAIT
28	MIITXD[0]	80	TXD1	132	D[10]	184	VCO[1]
29	MIITXEN	81	MIIPHYCLK	133	D[11]	185	PDOUT[1]
30	CLKOUT	82	MIIDC	134	D[12]	186	TEST1
31	VSSIO	83	MIIDIO	135	MEMCLK	187	NTEST2
32	VDDIO	84	TMS	136	VDDIO	188	VSSC
33	AV3CLK	85	TCK	137	VSSIO	189	VDDC
34	AV3CTRL[0]	86	VDDC	138	D[13]	190	NRESET
35	AV3CTRL[1]	87	VSSC	139	D[14]	191	VSSIO
36	VSSC	88	VSSIO	140	D[15]	192	VDDIO
37	USBVUSDV	89	VDDIO	141	SPICLK	193	VCO[0]
38	VDDC	90	NC	142	SPINCS[1]	194	PDOUT[0]
39	AV3DATA[0]	91	TEST5	143	SPINCS[0]	195	AV4CLK
40	AV3DATA[1]	92	NC	144	VDDC	196	AV0CTRL[0]
41	MIITXCLK	93	TDI	145	VSSC	197	AV0CTRL[1]
42	MIITXER	94	TDO	146	SPIMISO	198	AV2CLK
43	VDDIO	95	VDDC	147	SPIMOSI	199	AV2CTRL[0]
44	AV3DATA[2]	96	VSSC	148	NTEST3	200	AV2CTRL[1]
45	VSSIO	97	MIICRS	149	NTEST4	201	VDDIO
46	AV3DATA[3]	98	MIICOL	150	VSSIO	202	VSSIO
47	VDDUSB	99	GPIO[15]	151	VDDIO	203	XTALI
48	USB+	100	GPIO[14]	152	A[0]	204	XTALO
49	USB-	101	GPIO[13]	153	A[1]	205	VDDPLL
50	VSSUSB	102	GPIO[12]	154	A[2]	206	VSSPLL
51	USBVBUS	103	VDDIO	155	A[3]	207	VDDDCO
52	USBID	104	VSSIO	156	A[4]	208	VSSDCO

## DSP21367 (IC401: 1U-3808)

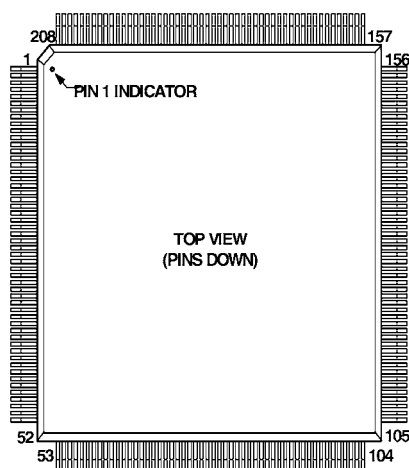

Pin No.	Signal	Pin No.	Signal	Pin No.	Signal	Pin No.	Signal
1	VDD	53	VDD	105	VDD	157	VDD
2	DATA28	54	GND	106	GND	158	VDD
3	DATA27	55	IOVDD	107	IOVDD	159	GND
4	GND	56	ADDR0	108	SDCAS	160	VDD
5	IOVDD	57	ADDR2	109	SDRAS	161	VDD
6	DATA26	58	ADDR1	110	SDCKE	162	VDD
7	DATA25	59	ADDR4	111	SDWE	163	TDI
8	DATA24	60	ADDR3	112	WR	164	TRST
9	DATA23	61	ADDR5	113	SDA10	165	TCK
10	GND	62	GND	114	GND	166	GND
11	VDD	63	VDD	115	IOVDD	167	VDD
12	DATA22	64	GND	116	SDCLK0	168	TMS
13	DATA21	65	IOVDD	117	GND	169	CLK_CFG0
14	DATA20	66	ADDR6	118	VDD	170	BOOTCFG0
15	IOVDD	67	ADDR7	119	RD	171	CLK_CFG1
16	GND	68	ADDR8	120	ACK	172	EMU
17	DATA19	69	ADDR9	121	FLAG3	173	BOOTCFG1
18	DATA18	70	ADDR10	122	FLAG2	174	TDO
19	VDD	71	GND	123	FLAG1	175	DAI4
20	GND	72	VDD	124	FLAG0	176	DAI2
21	DATA17	73	GND	125	DAI20	177	DAI3
22	VDD	74	IOVDD	126	GND	178	DAI1
23	GND	75	ADDR11	127	VDD	179	IOVDD
24	VDD	76	ADDR12	128	GND	180	GND
25	GND	77	ADDR13	129	IOVDD	181	VDD
26	DATA16	78	GND	130	DAI19	182	GND
27	DATA15	79	VDD	131	DAI18	183	DPI14
28	DATA14	80	AVSS	132	DAI17	184	DPI13
29	DATA13	81	AVDD	133	DAI16	185	DPI12
30	DATA12	82	GND	134	DAI15	186	DPI11
31	IOVDD	83	CLKIN	135	DAI14	187	DPI10
32	GND	84	XTAL2	136	DAI13	188	DPI9
33	VDD	85	IOVDD	137	DAI12	189	DPI8
34	GND	86	GND	138	VDD	190	DPI7
35	DATA11	87	VDD	139	IOVDD	191	IOVDD
36	DATA10	88	ADDR14	140	GND	192	GND
37	DATA9	89	GND	141	VDD	193	VDD
38	DATA8	90	IOVDD	142	GND	194	GND
39	DATA7	91	ADDR15	143	DAI11	195	DPI6
40	DATA6	92	ADDR16	144	DAI10	196	DPI5
41	IOVDD	93	ADDR17	145	DAI8	197	DPI4
42	GND	94	ADDR18	146	DAI9	198	DPI3
43	VDD	95	GND	147	DAI6	199	DPI1
44	DATA4	96	IOVDD	148	DAI7	200	DPI2
45	DATA5	97	ADDR19	149	DAI5	201	CLKOUT
46	DATA2	98	ADDR20	150	IOVDD	202	RESET
47	DATA3	99	ADDR21	151	GND	203	IOVDD
48	DATA0	100	ADDR23	152	VDD	204	GND
49	DATA1	101	ADDR22	153	GND	205	DATA30
50	IOVDD	102	MS1	154	VDD	206	DATA31
51	GND	103	MS0	155	GND	207	DATA29
52	VDD	104	VDD	156	VDD	208	VDD

M3087BFBKBP (IC201: 1U-3808)

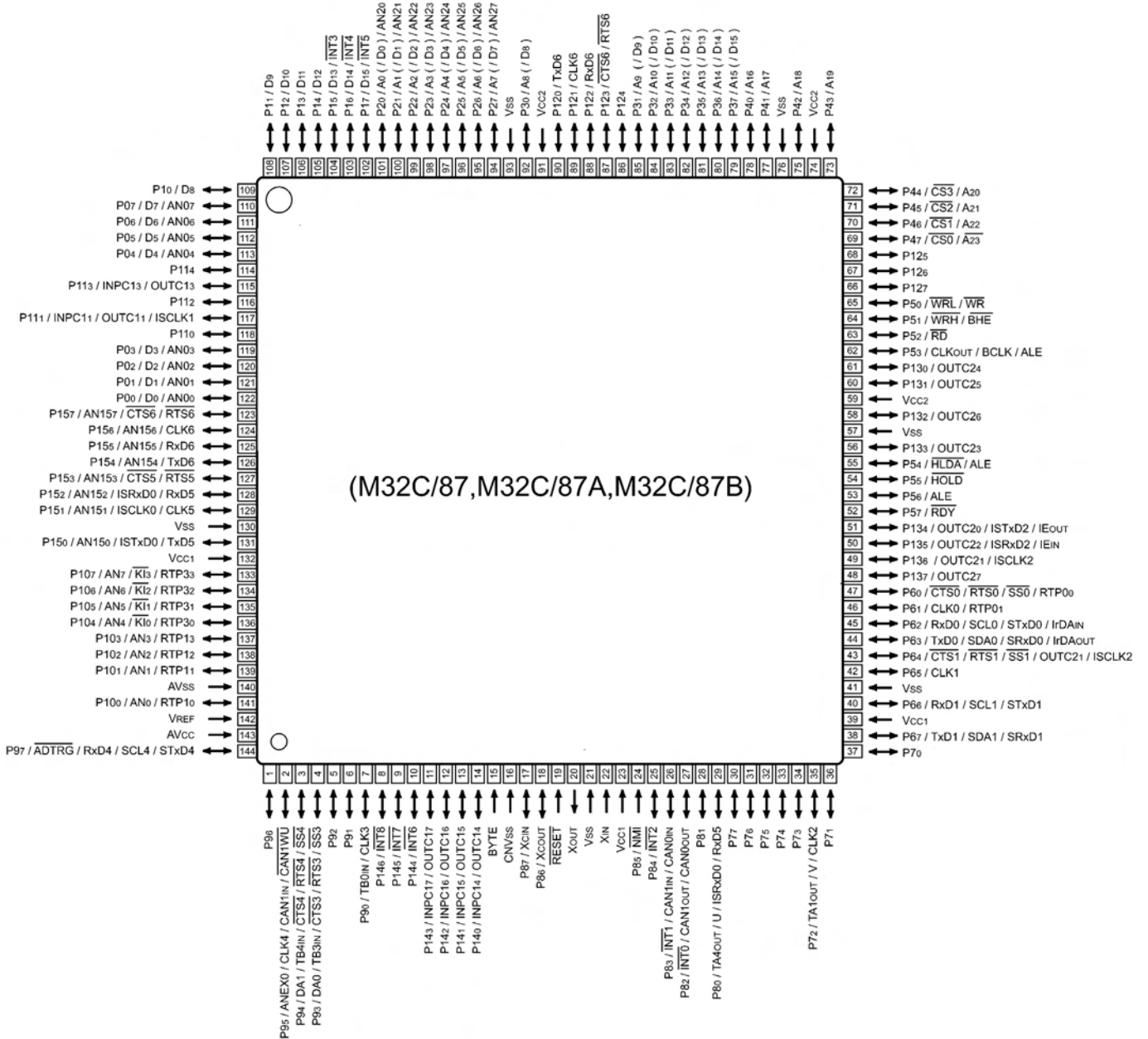

Pin No	Function	Port name	Port setting	INIT	PU	Explanation
1	P96	N.C.	O		-	OPEN
2	P95	N.C.	O		-	OPEN
3	P94	ON/_STBY	O		-	ON/OFF control of MAIN POWER
4	P93	OSD_ACK	I		Pu	OSD controller communication ACK input
5	P92	OSD_MTXD	SO		Pu	OSD controller communication data output
6	P91	OSD_DRXD	SI		Pu	OSD controller communication data input
7	P90	OSD_CLK	SO		-	OSD controller communication clock output
8	P146	N.C.	O		-	OPEN
9	P145	N.C.	O		-	OPEN
10	P144	N.C.	O		-	OPEN
11	P143	N.C.	O		-	OPEN
12	P142	_TEMP_DET	I		Pu	Temperature malfunction detection signal (malfunction detection : L)
13	P141	AUX_SW	I	FR	Pu	Plug insertion detection signal of front AUX input (Connected: H)
14	P140	HP_SW	I	FR	Pu	Headphone insertion detection signal (Connected: H)
15					-	Connect to GND
16		CNVSS1	I		Pd	Internal flash memory update choice signal
17	P87	RESERVE 32.768K	O		-	Sub clock circuit (OPEN) 32.768kHz
18	P86	RESERVE 32.768K	O		-	Sub clock circuit (OPEN) 32.768kHz

Pin No	Function	Port name	Port setting	INIT	PU	Explanation
19					Pu DNS	RESET
20			O		-	24MHz
21					-	Connect to GND
22			I		-	24MHz
23					-	Connect to 3.3V
24	P85	NMI	I		-	Connect to VCC
25	P84	_REMOTE	INT	FR	Pu DNS	Remote control signal interruption ※ Pu is built in Photo Detectors.
26	P83	_PROTECT	INT		Pu DNS	Protect detection interruption of main (Protect:L)
27	P82	E_REQ	INT		Pd	DM850 communications need interruption
28	P81	P_DOWN( 50/60Hz )	EC		Pu DNS	Power supply 50/60Hz pulse signal input
29	P80	IPOD_MRXD	SI		Pu DNS	Rxd data input from iPod connect
30	P77	N.C.	O		-	OPEN
31	P76	IPOD_MTXD	SO		Pu DNS	Txd data output to of iPod connect
32	P75	VOL_B	I	FR	Pu DNS	JOG pulse input B for VOL
33	P74	VOL_A	I	FR	Pu DNS	JOG pulse input A for VOL
34	P73	PWB_CHK	I		Pd	P.W.B check mode (H:P.W.B check mode)
35	P72	BE_CLK	SI	BE	pd	SCI CLK input from ESS
36	P71	BE_MRXD	SI	BE	Pu	SCI DATA input from ESS
37	P70	BE_MTXD	SO	BE	Pu	SCI DATA output to ESS
38	P67	SYS_MTXD(AMX TXD)	SO		Pu DNS	TxD data output to AMX
39					-	Connect to +3.3V
40	P66	SYS_MRXD(AMX RXD)	SI		Pu DNS	RxD data input to AMX
41					-	Connect to GND
42	P65	_E_RST	O		Pd	Reset of DM850
43	P64	E_MODE	I		Pd	EMODE input from DM850
44	P63	IPOD_D_MTXD	SO		Pu DNS	TxD data output to of iPod Dock
45	P62	IPOD_D_MRXD	SI		Pu DNS	Rxd data input from of iPod Dock
46	P61	F_EXT_CK	O	FR	-	FRONT PANEL extended output port IC (BU2090F) for serial clock output LED lighting
47	P60	F_EXT_DA	O	FR	-	FRONT PANEL extended output port IC (BU2090F) for serial data output LED lighting
48	P137	_E_SPICS	O		-	SCI CE signal output to DM850
49	P136	E_CLK	SO		-	SCI CLK output to DM850
50	P135	E_DIN	SI		-	SCI DATA input from DM850
51	P134	E_DOUT	SO		-	SCI DATA output to DM850
52	P57	DC/DC_ON	O		-	ON/OFF control output of DC/DC CONV. ( ON: H)
53	P56	N.C.	O		-	OPEN
54	P55	F_EPM1	O		-	Flash rewriting
55	P54	IPOD_ID	O		-	iPod Accessory ID control signal(H:Connected, L:Unconnected)
56	P133	_SAN_RST	O		Pd	Reset output to of tuner RDS IC (L:Reset)
57					-	Connect to GND
58	P132	_TU_MU	O		Pd	Mute output of tuner (L:MUTE, H:MUTE OFF)
59					-	Connect to +3.3V
60	P131	TU_POWER	O		Pd	Power supply of tuner (+12V/+5V) ON/OFF H:P.ON
61	P130	IPOD_CNT	I		Pu DNS	Connected detection of iPod (H:Unconnected, L:Connected)
62	P53	IPOD_ON	O		-	iPod Charge POWER control (Charge ON:H)
63	P52	_CHOP_ON	O		pd	POWER ON/OFF control output of peripheral circuit (H:OFF, L:ON)
64	P51	_OSD_RST	O		Pd	Reset to OSD uCom
65	P50	F_CE1	O		-	
66	P127	FAN ON/OFF	O		Pd	FAN ON/OFF control H:FAN ON
67	P126	FAN SPEED	O		-	FAN SPEED control H:Slow L:Fast
68	P125	N.C.	O		-	OPEN
69	P47	N.C.	O		-	OPEN
70	P46	N.C.	O		-	OPEN
71	P45	N.C.	O		-	OPEN
72	P44	N.C.	O		-	OPEN
73	P43	N.C.	O		-	OPEN
74					-	Connect to +3.3V
75	P42	IPOD_PROTECT	I		Pu	iPod protect detection (H:FNormal, L:GProtect)
76					-	Connect to GND
77	P41	N.C.	O		-	OPEN
78	P40	H/P MUTE_MAIN	O		Pu	Headphone MUTE signal(MUTE:H)
79	P37	PRE_MUTE_MAIN	O		Pu	PreOut MUTE signal (MUTE:H)
80	P36	SP_CON	I		pu	Speaker connection detection (SP connected:H)
81	P35	SP_RL	O		Pu	Relay MUTE signal for FRONT/SW speaker (Relay ON:H)
82	P34	iPod MUTE	O		Pu	iPod output MUTE (MUTE:H)
83	P33	DRV_ON	O	BE	-	DVD (ESS) power supply ON/OFF control of unit (ON:H)
84	P32	SYS_REQ	O	BE	-	Communication start request signal to ESS

Pin No	Function	Port name	Port setting	INIT	PU	Explanation
85	P31	N.C.			-	OPEN
86	P124	_BE_RST	O	BE	Pd	DVD (ESS) reset signal of unit
87	P123	BE_ON	I	BE	Pd	Input of ESS IC Active state output signal
88	P122	N.C.			-	OPEN
89	P121	N.C.	O		-	OPEN
90	P120	N.C.	O		-	OPEN
91					-	
92	P30	OSD_VUP	O		-	OSD version up change selecting signal
93					-	
94	P27	VUP_SEL2	O		-	Version upgrade UART switching selection 2
95	P26	VUP_SEL1	O		-	Version upgrade UART switching selection 1
96	P25	TU_STEREO	I		Pu	Stereo indicator input of tuner
97	P24	TUNED	I		Pu	Bureau existence detection input of tuner
98	P23	SAN_CE	O		-	Communication chip enable output to tuner PLL/RDS IC/FUNCTION IC(SANYO BUS)
99	P22	SAN_MOSI	O		-	Cereal data output to tuner PLL/RDS IC/FUNCTION IC(SANYO BUS)
100	P21	SAN_CK	O		-	Cereal clock output to tuner PLL/RDS IC/FUNCTION(SANYO BUS)
101	P20	SAN_MISO	I		Pu	Cereal data input from tuner PLL/RDS IC(SANYO BUS)
102	P17	BE_CS	INT	BE	Pd	CS interrupt of communication with ESS
103	P16	_BE_AUDIO_RST	INT	BE	Pu	Audio reset interrupt from ESS
104	P15	SUB_REQ	INT	AU	Pu	SUB uCom (AUDIO/VIDEO) communication demand interrupt
105	P14	E2P_CS	O		Pu DNS	Chip selection to EEPROM
106	P13	E2P_CLK	O		-	SCI clock to EEPROM
107	P12	E2P_MOSI	O		-	SCI DATA OUT to EEPROM
108	P11	E2P_MISO	I		-	SCI DATA IN to EEPROM
109	P10	N.C.	O		-	OPEN
110	P07	N.C.	O		-	OPEN
111	P06	N.C.	O		-	OPEN
112	P05	N.C.	O		-	OPEN
113	P04	N.C.	O		-	OPEN
114	P114	FL_CS	Çn		-	FL controller chip selection
115	P113	OSD_REQ	Çn		-	Request signal to OSD uCom
116	P112	N.C.	O		-	OPEN
117	P111	FL_CLK	SO		-	SCI clock output to FL controller
118	P110	FL_DOUT	SO		-	SCI data output to FL controller
119	P03	N.C.	O		-	OPEN
120	P02	N.C.	O		-	OPEN
121	P01	N.C.	O		-	OPEN
122	P00	N.C.	O		-	OPEN
123	P157	DIMMER	AD	FR	Pd	Illuminance sensor input
124	P156	_FL_RST	O		Pd	FLT display driver reset signal (Reset:L)
125	P155	N.C.	O		-	OPEN
126	P154	_SUB_RST	O	AU	Pd	Reset of SUB uCom (AUDIO/VIDEO)
127	P153	SUB_ACK	O	AU	-	ACK output to SUB uCom (AUDIO/VIDEO)
128	P152	SUB_MRXD	SI	AU	Pu	SCI data input from SUB uCom (AUDIO/VIDEO)
129	P151	SUB_CLK	SO	AU	-	SCI clock output to SUB uCom (AUDIO/VIDEO)
130					-	
131	P150	SUB_MTXD	SO	AU	Pu	SCI data output to SUB uCom (AUDIO/VIDEO)
132					-	
133	P107	PULL_UP	I		Pu DNS	PULL UP(necessity key interruption is put)
134	P106	KEY2	AD	FR	Pu	Detection input 2 of substance operation button input
135	P105	KEY1	AD	FR	Pu	Detection input 1 of substance operation button input
136	P104	KEY0	AD	FR	Pu	Detection input 0 of substance operation button input
137	P103	MODE2	AD		-	DVD REGION selection input
138	P102	MODE1	AD		-	Treatment area selection input of product
139	P101	N.C.	AD		Pu	+3.3V fixing
140					-	Connect to GND
141	P100	SW1_IN	AD		-	HDMI/PROGRESSIVE/INTERLACE change SW input (H: HDMI, M: PROG, L: INT)
142					-	Connect to +3.3V
143					-	Connect to +3.3V
144	P97	N.C.	O		-	OPEN

**FRONT PANEL extension output port (BU2090F P60: F\_EXT\_DA /P61: F\_EXT\_CK) (IC202:1U-3810 )**

Pin No	Port	Port Name	Port setting	INIT	PU	Explanation
4		ON/ST_RD	O		-	POWER button red LED lighting control: Red lighting at standby(lightning: L. )
5		ON/ST_YL	O		-	POWER button yellow LED lighting control: Yellow lighting at timer standby(lightning: L. )
6		OP/CL_LED	O		-	OPEN/CLOSE button LED lighting control(lightning: L. )
7		STOP_LED	O		-	STOP button LED lighting control(lightning: L. )
8		FUNC_LED	O		-	FUNC button LED lighting control(lightning: L. )
9		REV_LED	O		-	A.REV button LED lighting control(lightning: L. )
10		AFWD_LED	O		-	A.FWD button LED lighting control(lightning: L. )
11		PLAY_LED	O		-	PLAY button LED lighting control(lightning: L. )
12		VOLT_A	O		-	LED lighting voltage control A
13		VOLT_B	O		-	LED lighting voltage control B
14		VOLT_C	O		-	LED lighting voltage control C
15		ON/ST_BL	O		-	POWER button blue LED lighting control: Blue lighting at POWER ON(lightning: L.)

**FL driver extension output port (M66005-0001AHP)**

Pin No	Port	Port Name	Port setting	INIT	PU	Explanation
9		FEX_PWR	O	FR	-	FRONT PANEL expansion output IC (BU2090F)power supply control H:P.ON



M30627FHPGP (IC301: 1U-3808)

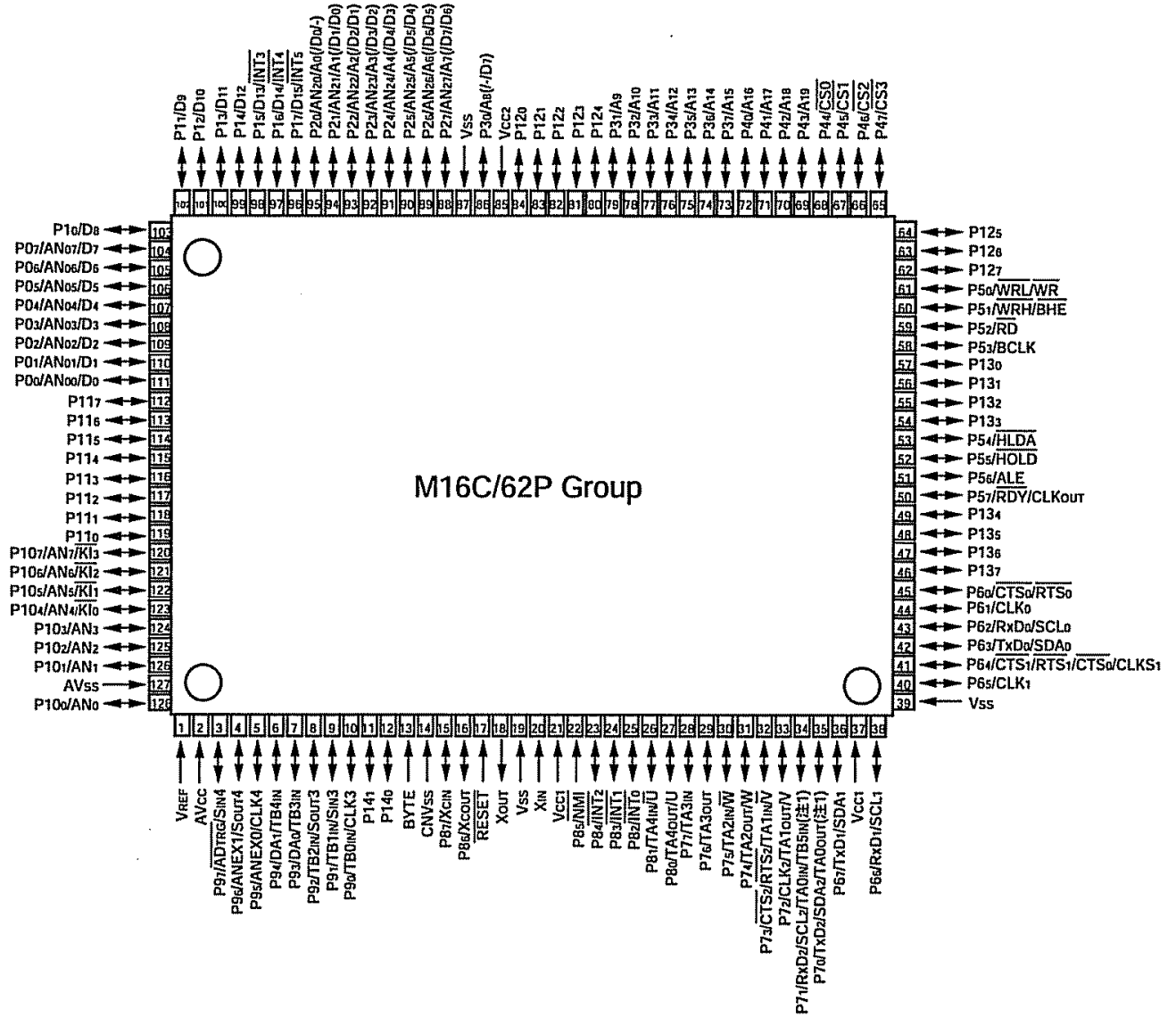

Pin No	Port name	Function	I/O	Explanation
1	VREF	VREF	-	AD standard +3.3V
2	AVCC	AVCC	-	AD +3.3V
3	P97/SIN4	DSP_MISO	I	Data input from DSP
4	P96/SOUT4	DSP_MOSI	O	Data output to DSP
5	P95/CLK4	DSP_CK	O	Clock output to DSP
6	P94	I2CSEL	O	I2C switching control terminal ( ESS / Sub-uCom )
7	P93	N.C.	O	OPEN
8	P92/SOUT3	N.C.	O	OPEN
9	P91/SIN3	N.C.	O	OPEN
10	P90/CLK3	N.C.	O	OPEN
11	P141	N.C.	O	OPEN
12	P140	_FLL_RST	O	FLI2310 reset
13	BYTE	BYTE	-	GND(Ext. data bus bit width switching, 16bit="L")
14	CNVCS	CNVSS	-	Singlechip/Microprocessor mode switching (Normal single-chip:L, Rewrite boot program start:H input set)
15	P87	N.C.	O	OPEN
16	P86	_HDMIT_RST	O	Reset for HDMI TRANSMITTER (Si I9030)
17	RESET	SUB_RST	I	Reset signal input from main uCom
18	XOUT	X1	O	Connect to Oscillator
19	VSS	VSS	-	GND
20	XIN	X2	I	Connect to Oscillator
21	VCC1	VCC1	-	+3.3V
22	P85/NMI	_NMI	I	Not used(Fixed:"H")

Pin No	Port name	Function	I/O	Explanation
23	P84/INT2	_DIR_INT	I	DIR interrupt input
24	P83/INT1	SUB_ACK	I	MAIN-SUB uCom communications control input terminal (ACK "L" return from main uCom)
25	P82/INT0	N.C.	O	OPEN
26	P81/TA4IN	N.C.	O	OPEN
27	P80	PWB_CHK	O	PWB check
28	P77	_DEC_RST	O	Reset for ADV7403
29	P76	_ENC2_RST	O	Reset for ADV7320-2
30	P75/TA2IN	N.C.		OPEN
31	P74/TA2OUT	N.C.		OPEN
32	P73/CTS2/TA1IN	N.C.		OPEN
33	P72/CLK2	N.C.	O	OPEN
34	P71/RXD2	N.C.	O	OPEN
35	P70/TXD2	N.C.	O	OPEN
36	P67/TXD1	F_TXD2	O	Data output for Flash rewriting /HDMI DEBUG 5 (DEBUG output for communication)
37	VCC1	VCC1	-	+3.3V
38	P66/RXD1	F_RXD2	O	Data output for Flash rewriting /HDMI DEBUG 4 (DEBUG output for communication)
39	VSS	VSS	-	GND
40	P65/CLK1	N.C.	O	OPEN
41	P64/CTS1	N.C.	O	OPEN
42	P63/TXD0	SUB_STXD	O	Data output to of main uCom
43	P62/RXD0	SUB_SRXD	I	Data input to of main uCom
44	P61/CLK0	SUB_CLK	I	Clock input from of main uCom
45	P60/CTS0	SUB_REQ	O	Communication Request to of main uCom
46	P137	CK_SEL	O	Video Encoder clock switching for ZONE2
47	P136	HD/_SD	O	VideoEncoder resolution switching(SD/SD or more)
48	P135	HDMI_DEBUG_3	O	HDMI DEBUG 3 (DEBUG output)
49	P134	HDMI_DEBUG_6	O	HDMI DEBUG 6 (DEBUG output)
50	P57	_ENC1_RST	O	Reset for ADV7320-1
51	P56	V_DET	I	CVBS video input detection
52	P55/EPM	F_EPM2	O	Port for Flash rewriting/HDMI DEBUG 2 (DEBUG output)
53	P54	N.C.	O	OPEN
54	P133	N.C.	O	OPEN
55	P132	HDMI_SCL	I/O	VIDEO I2C clock (HDMI system)
56	P131	HDMI_SDA	I/O	VIDEO I2C data (HDMI system)
57	P130	VD_SCL	I/O	VIDEO I2C clock (Video processing system)
58	P53	VD_SDA	I/O	VIDEO I2C data (Video processing system)
59	P52	N.C.	O	OPEN
60	P51	N.C.	O	OPEN
61	P50/CE	_F_CE2	O	Port for Flash rewriting/HDMI DEBUG 1 (DEBUG output)
62	P127	P_SAVE	O	COMPONENT → CONVERT route DISABLE terminal
63	P126	N.C.	O	OPEN
64	P125	N.C.	O	OPEN
65	P47	N.C.	O	OPEN
66	P46	N.C.	O	OPEN
67	P45	FNVL_DA	O	Function volume IC data output (RENESAS system data)
68	P44	FNVL_CK	O	Function volume IC clock output (RENESAS system clock)
69	P43	FNVL_CE	O	Function volume IC latch output (RENESAS system latch )
70	P42	N.C.	O	OPEN
71	P41	N.C.	O	OPEN
72	P40	N.C.	O	OPEN
73	P37	N.C.	O	OPEN
74	P36	N.C.	O	OPEN
75	P35	N.C.	O	OPEN
76	P34	EXT_CK	O	Video system (+5V system) expansion output port clock output
77	P33	EXT_DA	O	Video system (+5V system) expansion output port clock output
78	P32	CODEC_MISO	I	Data input from CODEC
79	P31	HDMI_SENS	I	HDMI IN signal presence detection input
80	P124	VSEL_CS1	O	Video selector PLD chip select
81	P123	VSEL_CS2	O	Video selector FPGA chip select
82	P122	CODEC_RST	O	CODEC reset output
83	P121	PRE_MUTE_SUB	O	Mute output of volume output
84	P120	HP_MUTE_SUB	O	MUTE output of head phone MUTE:H
85	VCC2	VCC2	-	+3.3V
86	P30	BE/_DIR	O	Route of voice output (BE/external input) switching
87	VSS	VSS	-	GND
88	P27	CODEC_CE	O	ODEC chip enabling
89	P26	TCK_AV	O	Main PLD JTAG

Pin No	Port name	Function	I/O	Explanation
90	P25	DSP_IO_MUTE	O	DSP IO MUTE control output (DSO IO MUTE: H)
91	P24	_AD/DIG	O	AD way/DIGITAL switching (AD way:L)
92	P23	_ERR_MUTE	O	Mute output at time of DSP ERR occurrence (MUTE:L)
93	P22	_BSE	O	Bit Stream Enable(Bit Stream:L)
94	P21	TDO_VFPGA	I	Main PLD JTAG data input
95	P20	COMP_DET	I	Component video input detection
96	P17/INT5	TMS_AV	O	Main PLD JTAG clock output
97	P16/INT4	S_DET	I	S video input detection
98	P15/INT3	TDI_AV	O	Main PLD JTAG data output (S-302 schematic TDO_APLD inscription)
99	P14	VSEL_CLK	O	Video selector clock
100	P13	VSEL_DATA	O	Video selector data
101	P12	_COMP_MUTE2	O	COMPONENT output last step driver (NJM2581) MUTE signal (MUTE:L)
102	P11	_S/V_MUTE	O	YC/CVBS output MUTE signal (MUTE: L)
103	P10	nCONFIG	O	VIDEO PLD control terminal
104	P07/AN07	nCS	O	VIDEO PLD control terminal
105	P06/AN06	nDE	O	VIDEO PLD control terminal
106	P05/AN05	DDCLK	O	VIDEO PLD control terminal
107	P04/AN04	DATA_0	O	VIDEO PLD control terminal
108	P03/AN03	ASDI	O	VIDEO PLD control terminal
109	P02/AN02	_DIR_RST	O	DIR reset output Reset:L
110	P01/AN01	DIR_CE	O	DIR chip enabling
111	P00/AN00	DIR/CODEC_CK	O	DIR/CODEC clock output
112	P117	DIR_MISO	I	Data input from DIR
113	P116	DIR/CODEC_MOSI	O	Data output to DIR/CODEC
114	P115	_DSPROM_RST	O	ROM reset for DSP
115	P114	_DSP_RST	O	Reset for DSP (Reset:L)
116	P113	DSP_CS	O	DSP chip select
117	P112	FLAG0	I	DSP FLAG0 input
118	P111	N.C.	O	OPEN
119	P110	N.C.	O	OPEN
120	P107/AN7	Pull up	O	OPEN
121	P106/AN6	Pull up	O	OPEN
122	P105/AN5	Pull up	O	OPEN
123	P104/AN4	Pull up	O	OPEN
124	P103/AN3	Pull up	O	OPEN
125	P102/AN2	Pull up	O	OPEN
126	P101/AN1	Pull up	O	OPEN
127	AVSS	AVSS	-	AD GND
128	P100/AN0	CONF_DONE	O	VIDEO PLD control terminal

### IC302 expansion output (BU2090)

Port	Port name	I/O
Q0	SIN_SELA	O
Q1	SIN_SELB	O
Q2	SIN_SELC	O
Q3	VIN_SELA	O
Q4	VIN_SELB	O
Q5	VMONI_SEL	O
Q6	N.C.	O
Q7	N.C.	O
Q8	_COMP MUTE1	O
Q9	FIL_SEL	O
Q10	N.C.	O
Q11	SMONI_SEL	O

## AW9864 (IC402: 1U-3808)

VCC	1	86	Vss
DQ0	2	85	DQ15
VccQ	3	84	VSSQ
DQ1	4	83	DQ14
DQ2	5	82	DQ13
VSSQ	6	81	VcQ
DQ3	7	80	DQ12
DQ4	8	79	DQ11
VccQ	9	78	VSSQ
DQ5	10	77	DQ10
DQ6	11	76	DQ9
VSSQ	12	75	VcQ
DQ7	13	74	DQ8
NC	14	73	NC
VCC	15	72	VSS
DQM0	16	71	DQM1
WE	17	70	NC
CAS	18	69	NC
RAS	19	68	CLK
CS	20	67	CKE
NC	21	66	A9
BS0	22	65	A8
BS1	23	64	A7
A10/AP	24	63	A6
A0	25	62	A5
A1	26	61	A4
A2	27	60	A3
DQM2	28	59	DQM3
VCC	29	58	VSS
NC	30	57	NC
DQ16	31	56	DQ31
VSSQ	32	55	VcQ
DQ17	33	54	DQ30
DQ18	34	53	DQ29
VcQ	35	52	VSSQ
DQ19	36	51	DQ28
DQ20	37	50	DQ27
VSSQ	38	49	VcQ
DQ21	39	48	DQ26
DQ22	40	47	DQ25
VcQ	41	46	VSSQ
DQ23	42	45	DQ24
VCC	43	44	VSS

## PIN DESCRIPTION

PIN NAME	FUNCTION	DESCRIPTION
A0–A10	Address	Multiplexed pins for row and column address. Row address: A0–A10. Column address: A0–A7. A10 is sampled during a precharge command to determine if all banks are to be precharged or bank selected by BS0, BS1.
BS0, BS1	Bank Select	Select bank to activate during row address latch time, or bank to read/write during address latch time.
DQ0–DQ31	Data Input/Output	Multiplexed pins for data output and input.
CS	Chip Select	Disable or enable the command decoder. When command decoder is disabled, new command is ignored and previous operation continues.
RAS	Row Address Strobe	Command input. When sampled at the rising edge of the clock RAS, CAS and WE define the operation to be executed.
CAS	Column Address Strobe	Referred to RAS
WE	Write Enable	Referred to RAS
DQM0–DQM3	Input/output mask	The output buffer is placed at Hi-Z (with latency of 2) when DQM is sampled high in read cycle. In write cycle, sampling DQM high will block the write operation with zero latency.
CLK	Clock Inputs	System clock used to sample inputs on the rising edge of clock.
CKE	Clock Enable	CKE controls the clock activation and deactivation. When CKE is low, Power Down mode, Suspend mode, or Self Refresh mode is entered.
VCC	Power (+3.3V)	Power for input buffers and logic circuit inside DRAM.
VSS	Ground	Ground for input buffers and logic circuit inside DRAM.
VCCQ	Power (+3.3V) for I/O buffer	Separated power from VCC, to improve DQ noise immunity.
VSSQ	Ground for I/O buffer	Separated ground from VSS, to improve DQ noise immunity.
NC	No Connection	No connection

## NT5DS16M16CS (IC202: 1U-3809)

V <sub>DD</sub>	1	66	V <sub>SS</sub>
DQ0	2	65	DQ15
V <sub>DDQ</sub>	3	64	V <sub>SSQ</sub>
DQ1	4	63	DQ14
DQ2	5	62	DQ13
V <sub>SSQ</sub>	6	61	V <sub>DDQ</sub>
DQ3	7	60	DQ12
DQ4	8	59	DQ11
V <sub>DDQ</sub>	9	58	V <sub>SSQ</sub>
DQ5	10	57	DQ10
DQ6	11	56	DQ9
V <sub>SSQ</sub>	12	55	V <sub>DDQ</sub>
DQ7	13	54	DQ8
NC	14	53	NC
V <sub>DDQ</sub>	15	52	V <sub>SSQ</sub>
LDQS	16	51	UDQS
NC	17	50	NC
V <sub>DD</sub>	18	49	V <sub>REF</sub>
NU	19	48	V <sub>SS</sub>
LDM*	20	47	UDM*
WE	21	46	CK
CAS	22	45	CK
RAS	23	44	CKE
CS	24	43	NC
NC	25	42	A12
BA0	26	41	A11
BA1	27	40	A9
A10/AP	28	39	A8
A0	29	38	A7
A1	30	37	A6
A2	31	36	A5
A3	32	35	A4
V <sub>DD</sub>	33	34	V <sub>SS</sub>

## Input/Output Functional Description

Symbol	Type	Function
CK, $\overline{CK}$	Input	<b>Clock:</b> CK and $\overline{CK}$ are differential clock inputs. All address and control input signals are sampled on the crossing of the positive edge of CK and negative edge of $\overline{CK}$ . Output (read) data is referenced to the crossings of CK and $\overline{CK}$ (both directions of crossing).
CKE	Input	<b>Clock Enable:</b> CKE HIGH activates, and CKE Low deactivates, internal clock signals and device input buffers and output drivers. Taking CKE Low provides Precharge Power Down and Self Refresh operation (all banks idle), or Active Power Down (row Active in any bank). CKE is synchronous for power down entry and exit, and for self refresh entry. CKE is asynchronous for self refresh exit. CKE must be maintained high throughout read and write accesses. Input buffers, excluding CK, $\overline{CK}$ and CKE are disabled during Power Down. Input buffers, excluding CKE, are disabled during self refresh. The standard pinout includes one CKE pin.
$\overline{CS}$	Input	<b>Chip Select:</b> All commands are masked when $\overline{CS}$ is registered high. $\overline{CS}$ provides for external bank selection on systems with multiple banks. $\overline{CS}$ is considered part of the command code. The standard pinout includes one $\overline{CS}$ pin.
RAS, $\overline{CAS}$ , $\overline{WE}$	Input	<b>Command Inputs:</b> RAS, $\overline{CAS}$ and $\overline{WE}$ (along with $\overline{CS}$ ) define the command being entered.
DM	Input	<b>Input Data Mask:</b> DM is an input mask signal for write data. Input data is masked when DM is sampled high coincident with that input data during a Write access. DM is sampled on both edges of DQS. Although DM pins are input only, the DM loading matches the DQ and DQS loading. During a Read, DM can be driven high, low, or floated.
BA0, BA1	Input	<b>Bank Address Inputs:</b> BA0 and BA1 define to which bank an Active, Read, Write or Precharge command is being applied. BA0 and BA1 also determines if the mode register or extended mode register is to be accessed during a MRS or EMRS cycle.
A0 - A12	Input	<b>Address Inputs:</b> Provide the row address for Active commands, and the column address and Auto Precharge bit for Read/Write commands, to select one location out of the memory array in the respective bank. A10 is sampled during a Precharge command to determine whether the Precharge applies to one bank (A10 low) or all banks (A10 high). If only one bank is to be precharged, the bank is selected by BA0, BA1. The address inputs also provide the op-code during a Mode Register Set command.
DQ	Input/Output	<b>Data Input/Output:</b> Data bus.
DQS, LDQS, UDQS	Input/Output	<b>Data Strobe:</b> Output with read data, input with write data. Edge-aligned with read data, centered in write data. Used to capture write data. For the x16, LDQS corresponds to the data on DQ0-DQ7; UDQS corresponds to the data on DQ8-DQ15
NC		<b>No Connect:</b> No internal electrical connection is present.
NU		Electrical connection is present. Should not be connected at second level of assembly.
V <sub>DDQ</sub>	Supply	<b>DQ Power Supply:</b> 2.5V ± 0.2V for DDR333; 2.6V ± 0.1V for DDR400.
V <sub>SSQ</sub>	Supply	<b>DQ Ground</b>
V <sub>DD</sub>	Supply	<b>Power Supply:</b> 2.5V ± 0.2V for DDR333; 2.6V ± 0.1V for DDR400.
V <sub>SS</sub>	Supply	<b>Ground</b>
V <sub>REF</sub>	Supply	<b>SSTL_2 reference voltage</b>

## K4S641632 (IC103: 1U3808)

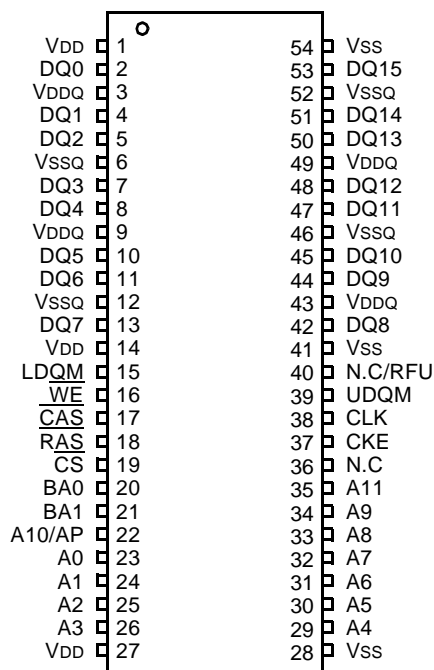

54Pin TSOP (II)  
(400mil x 875mil)  
(0.8 mm Pin pitch)

## PIN FUNCTION DESCRIPTION

Pin	Name	Input Function
CLK	<i>System clock</i>	Active on the positive going edge to sample all inputs.
$\overline{\text{CS}}$	<i>Chip select</i>	Disables or enables device operation by masking or enabling all inputs except CLK, CKE and L(U)DQM
CKE	<i>Clock enable</i>	Masks system clock to freeze operation from the next clock cycle. CKE should be enabled at least one cycle prior to new command. Disable input buffers for power down in standby.
A <sub>0</sub> ~ A <sub>11</sub>	<i>Address</i>	Row/column addresses are multiplexed on the same pins. Row address : RA <sub>0</sub> ~ RA <sub>11</sub> , Column address : CA <sub>0</sub> ~ CA <sub>7</sub>
BA <sub>0</sub> ~ BA <sub>1</sub>	<i>Bank select address</i>	Selects bank to be activated during row address latch time. Selects bank for read/write during column address latch time.
$\overline{\text{RAS}}$	<i>Row address strobe</i>	Latches row addresses on the positive going edge of the CLK with $\overline{\text{RAS}}$ low. Enables row access & precharge.
$\overline{\text{CAS}}$	<i>Column address strobe</i>	Latches column addresses on the positive going edge of the CLK with $\overline{\text{CAS}}$ low. Enables column access.
$\overline{\text{WE}}$	<i>Write enable</i>	Enables write operation and row precharge. Latches data in starting from $\overline{\text{CAS}}$ , $\overline{\text{WE}}$ active.
L(U)DQM	<i>Data input/output mask</i>	Makes data output Hi-Z, tSHZ after the clock and masks the output. Blocks data input when L(U)DQM active.
DQ <sub>0</sub> ~ 15	<i>Data input/output</i>	Data inputs/outputs are multiplexed on the same pins.
VDD/VSS	<i>Power supply/ground</i>	Power and ground for the input buffers and the core logic.
VDDQ/VSSQ	<i>Data output power/ground</i>	Isolated power supply and ground for the output buffers to provide improved noise immunity.
N.C/RFU	<i>No connection /reserved for future use</i>	This pin is recommended to be left No Connection on the device.

## TAS5142DKD (IC206: 1U-3811)

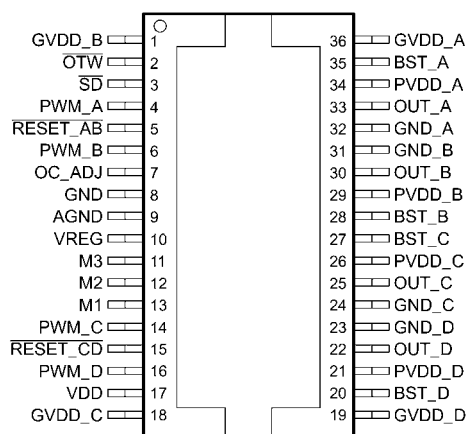

## Terminal Functions

TERMINAL		FUNCTION (1)	DESCRIPTION
NAME	DKD NO.		
AGND	9	P	Analog ground
BST_A	35	P	HS bootstrap supply (BST), external capacitor to OUT_A required
BST_B	28	P	HS bootstrap supply (BST), external capacitor to OUT_B required
BST_C	27	P	HS bootstrap supply (BST), external capacitor to OUT_C required
BST_D	20	P	HS bootstrap supply (BST), external capacitor to OUT_D required
GND	8	P	Ground
GND_A	32	P	Power ground for half-bridge A
GND_B	31	P	Power ground for half-bridge B
GND_C	24	P	Power ground for half-bridge C
GND_D	23	P	Power ground for half-bridge D
GVDD_A	36	P	Gate-drive voltage supply requires 0.1- $\mu$ F capacitor to AGND
GVDD_B	1	P	Gate-drive voltage supply requires 0.1- $\mu$ F capacitor to AGND
GVDD_C	18	P	Gate-drive voltage supply requires 0.1- $\mu$ F capacitor to AGND
GVDD_D	19	P	Gate-drive voltage supply requires 0.1- $\mu$ F capacitor to AGND
M1	13	I	Mode selection pin
M2	12	I	Mode selection pin
M3	11	I	Mode selection pin
NC	–	–	No connect. Pins may be grounded.
OC_ADJ	7	O	Analog overcurrent programming pin requires resistor to ground
OTW	2	O	Overtemperature warning signal, open-drain, active-low
OUT_A	33	O	Output, half-bridge A
OUT_B	30	O	Output, half-bridge B
OUT_C	25	O	Output, half-bridge C
OUT_D	22	O	Output, half-bridge D
PVDD_A	34	P	Power supply input for half-bridge A requires close decoupling of 0.1- $\mu$ F capacitor to GND_A.
PVDD_B	29	P	Power supply input for half-bridge B requires close decoupling of 0.1- $\mu$ F capacitor to GND_B.
PVDD_C	26	P	Power supply input for half-bridge C requires close decoupling of 0.1- $\mu$ F capacitor to GND_C.
PVDD_D	21	P	Power supply input for half-bridge D requires close decoupling of 0.1- $\mu$ F capacitor to GND_D.
PWM_A	4	I	Input signal for half-bridge A
PWM_B	6	I	Input signal for half-bridge B
PWM_C	14	I	Input signal for half-bridge C
PWM_D	16	I	Input signal for half-bridge D
RESET_AB	5	I	Reset signal for half-bridge A and half-bridge B, active-low
RESET_CD	15	I	Reset signal for half-bridge C and half-bridge D, active-low
SD	3	O	Shutdown signal, open-drain, active-low
VDD	17	P	Power supply for digital voltage regulator requires 0.1- $\mu$ F capacitor to GND.
VREG	10	P	Digital regulator supply filter pin requires 0.1- $\mu$ F capacitor to AGND.

(1) I = input, O = output, P = power



## TAS5121DKD (IC207: 1U-3811)

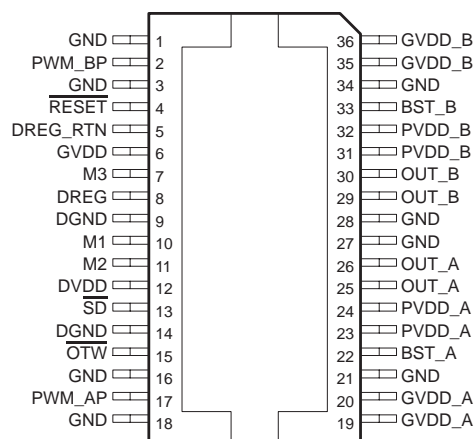

## Terminal Functions

TERMINAL		FUNCTION(1)	DESCRIPTION
NAME	DKD		
BST_A	22	P	High side bootstrap supply (BST), external resistor and capacitor to OUT_A required
BST_B	33	P	High side bootstrap supply (BST), external resistor and capacitor to OUT_B required
DGND	9, 14	P	I/O reference ground
DREG	8	P	Digital supply voltage regulator decoupling pin, 1 $\mu$ F capacitor connected to DREG_RTN
DREG_RTN	5	P	Decoupling return pin
DVDD	12	P	I/O reference supply input: 100 $\Omega$ to DREG, decoupled to GND, 0.1 $\mu$ F capacitor connected to GND
GND	1, 3, 16, 18, 21, 27, 28, 34	P	Power ground, connected to system GND
GVDD	6	P	Local GVDD decoupling \pin
GVDD_A	19, 20	P	Gate drive input voltage
GVDD_B	35, 36	P	Gate drive input voltage
M1	10	I	Protection mode selection pin, connect to GND
M2	11	I	Protection mode selection pin, connect to DREG
M3	7	I	Output mode selection pin; connect to GND
OTW	15	O	Overtemperature warning output, open drain with internal pullup, active-low when temperature exceeds 115°C
OUT_A	25, 26	O	Output, half-bridge A
OUT_B	29, 30	O	Output, half-bridge B
PVDD_A	23, 24	P	Power supply input for half-bridge A
PVDD_B	31, 32	P	Power supply input for half-bridge B
PWM_AP	17	I	PWM input signal, half-bridge A
PWM_BP	2	I	PWM input signal, half-bridge B
RESET	4	I	Reset signal, active low
SD	13	O	Shutdown signal for half-bridges A and B (open drain with internal pullup)

(1) I = input, O = Output, P = Power

## BU2360FV (IC109: 1U-3808)

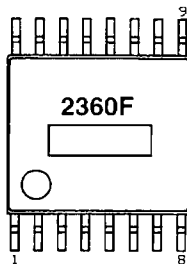

## ○ Pin Function

Pin No.	PIN NAME	Function
1	VDD2	Power supply for 27MHz
2	VSS2	GND for 27MHz
3	CLK27M1	27MHz Clock output terminal ( CL=40pF )
4	CLK27M2	27MHz Clock output terminal ( CL=25pF )
5	AVDD	Power supply for Analog block
6	AVSS	GND for Analog block
7	XTALIN	Crystal input terminal
8	XTALOUT	Crystal output terminal
9	CLK512FS2	512fs Clock output terminal 2 ( 22.5792 or 24.576MHz)
10	CLK512FS1	512fs Clock output terminal 1 ( 22.5792 or 24.576MHz)
11	DVSS	Power supply for Digital block
12	DVDD	GND for Digital block
13	CLK33M2	33.8688MHz Clock output terminal 2
14	FSEL	FS select ( L : 44.1kHz, OPEN : 48kHz ) : with pull-up
15	CLK33M1	33.8688MHz Clock output terminal 1
16	OE	Output enable ( L : disable, OPEN : enable ) : with pull-up

## BD7820 (IC511: 1U-3809)

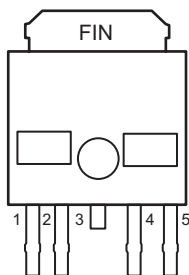

Pin No.	Pin Name
1	CTL
2	Vcc
3	N.C.
4	OUT
5	ADJ
FIN	GND

## BLOCK DIAGRAM

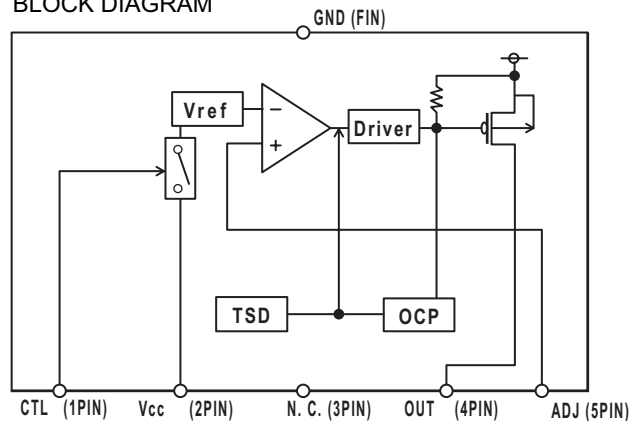







1U-3809 VIDEO P.W.B. UNIT (1/2)

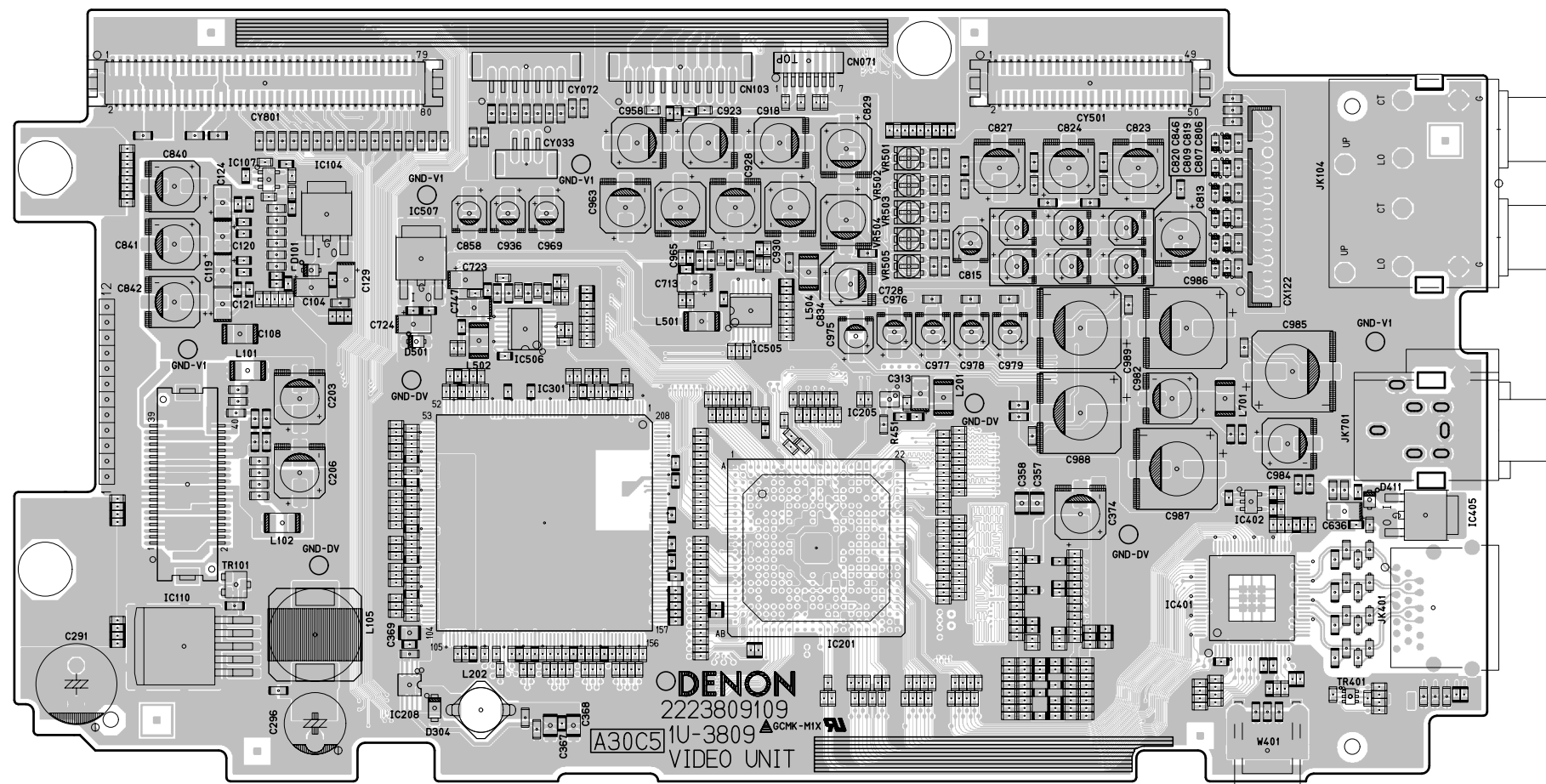
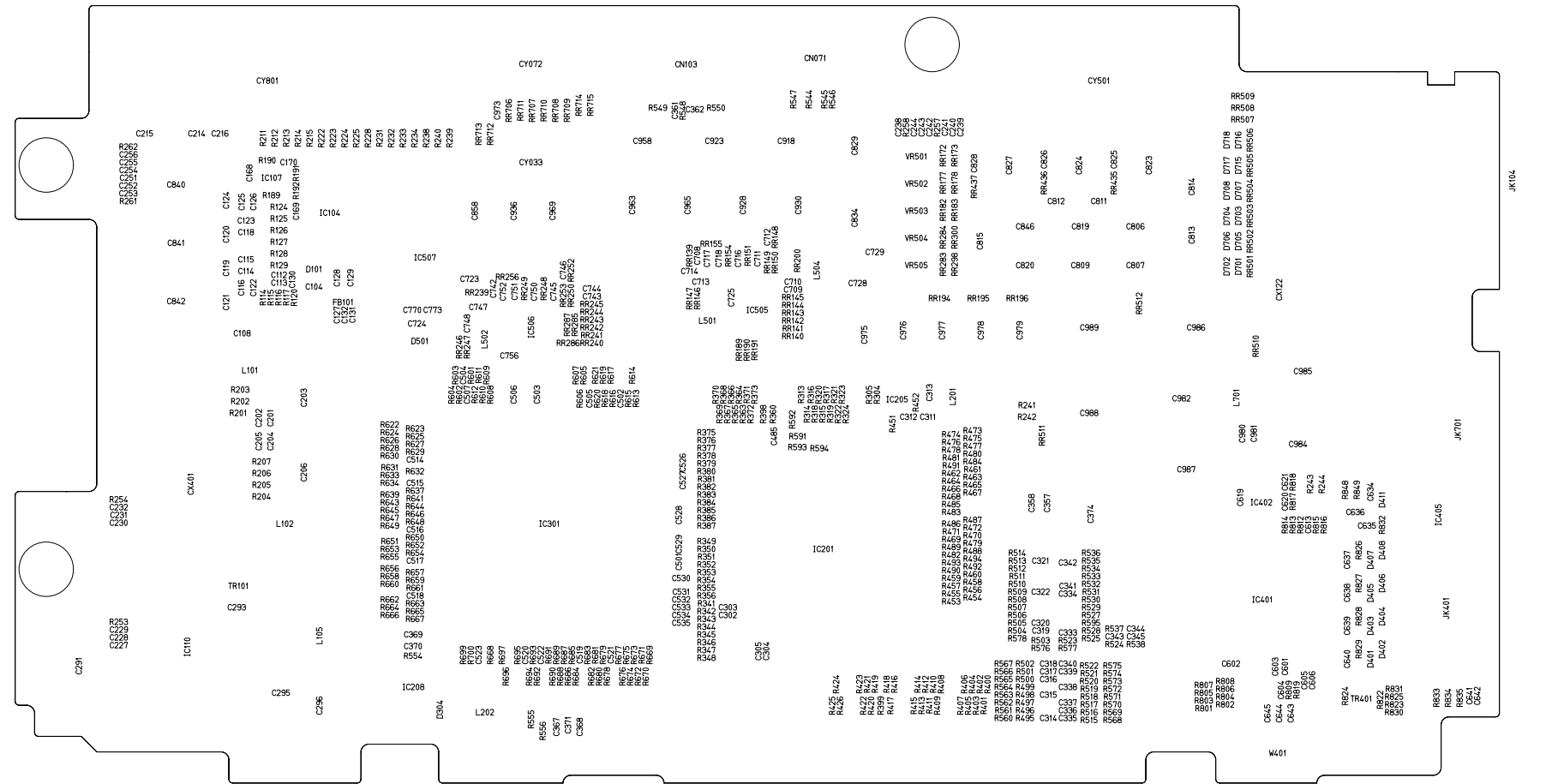

DENON  
 2223809109  
 A30C5 1U-3809 VIDEO UNIT  
 GCMK-MIX

COMPONENT SIDE





1U-3810 L.PWR/DISP P.W.B. UNIT (1/2)

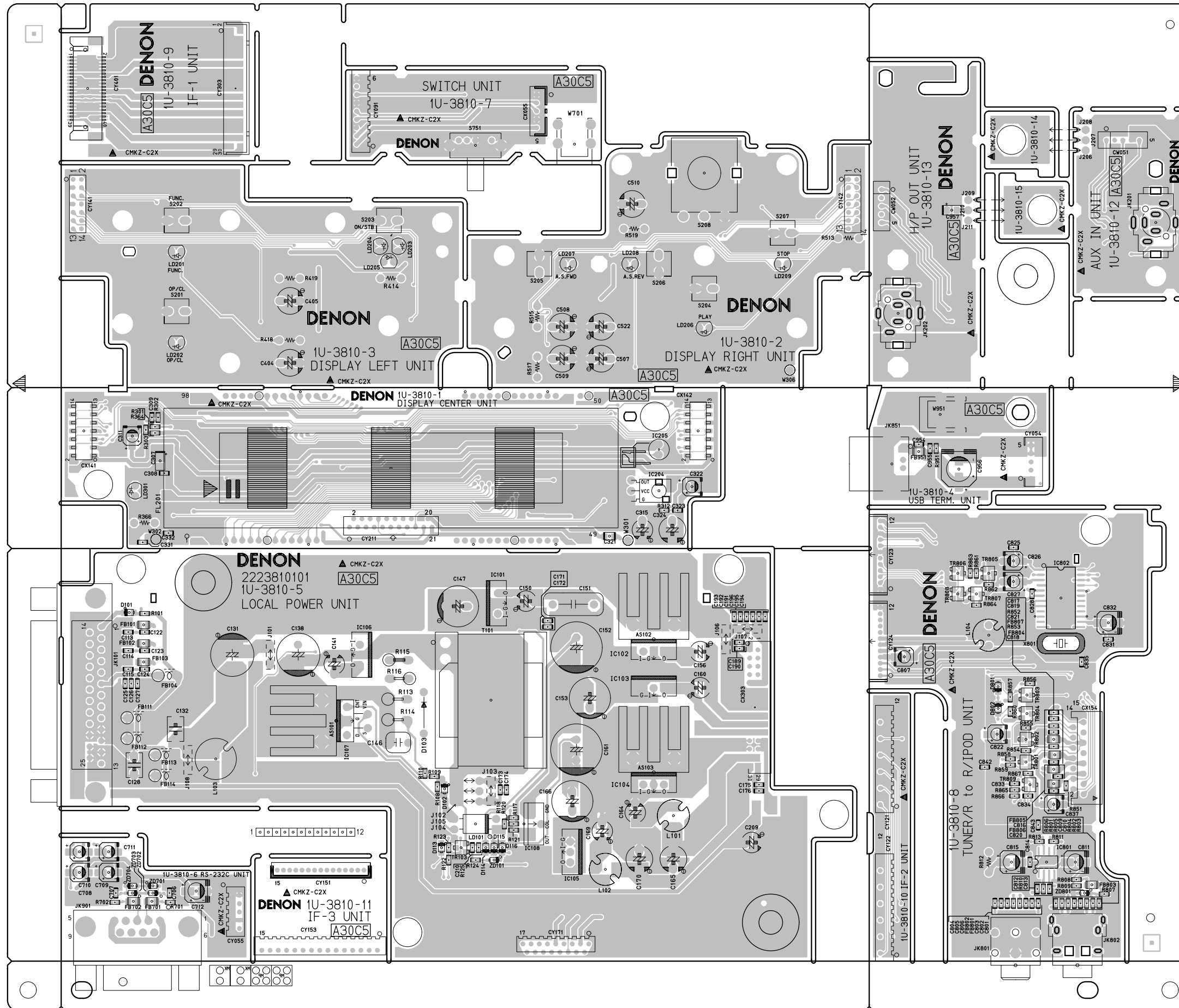



1U-3810 L.PWR/DISP P.W.B. UNIT (2/2)

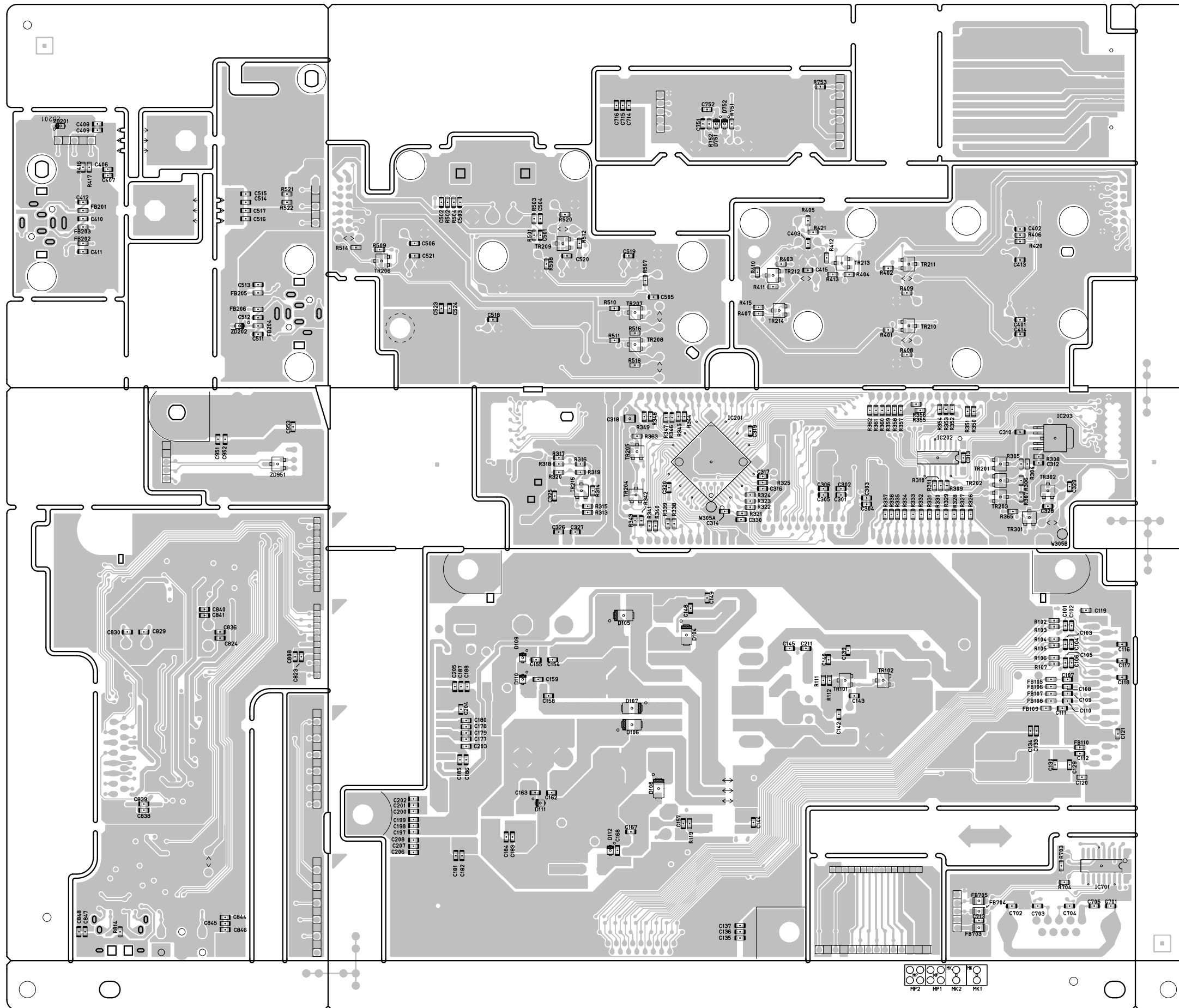

FOIL SIDE

1U-3811 D.AMP/SMPS P.W.B. UNIT (1/2)

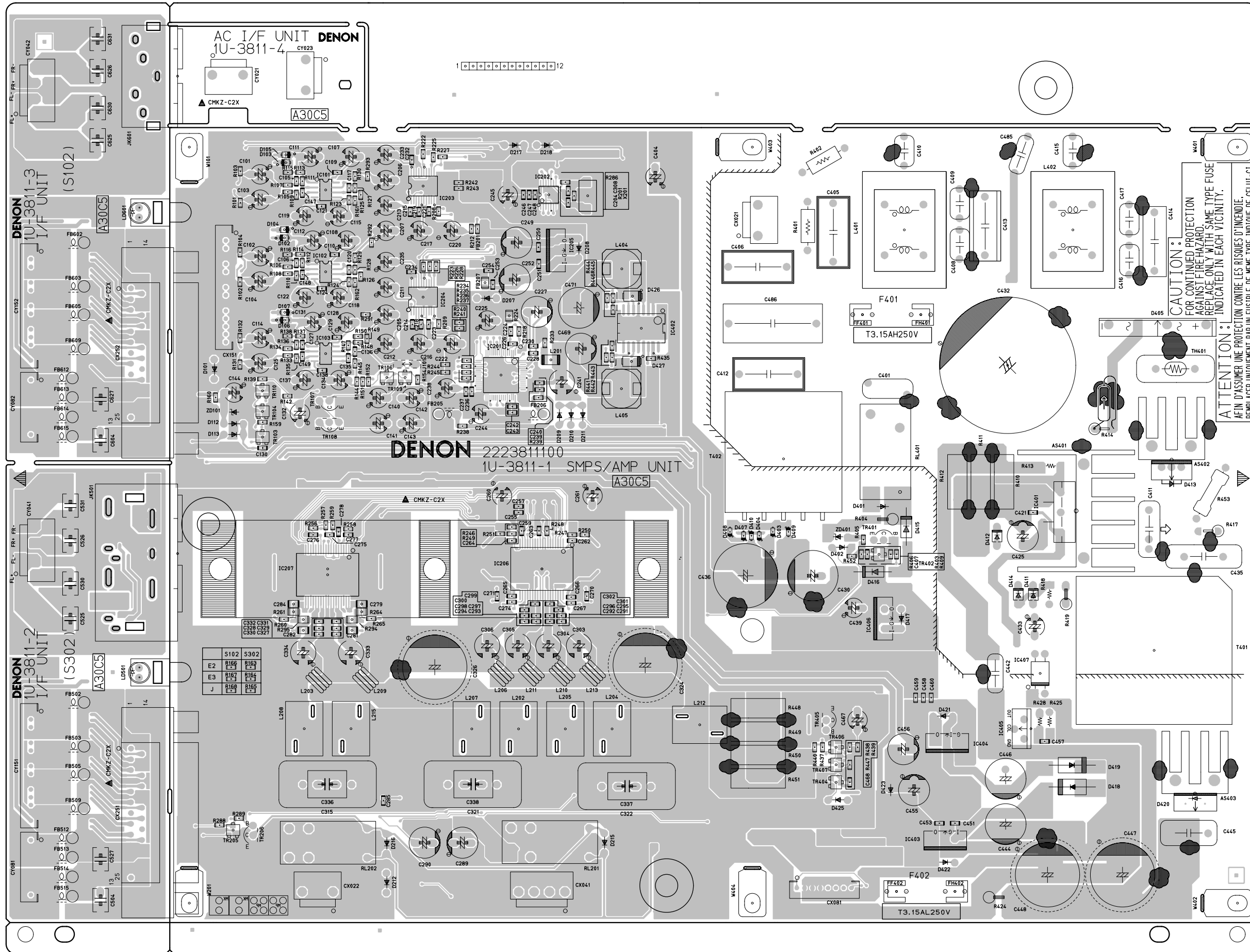

COMPONENT SIDE

1U-3811 D.AMP/SMPS P.W.B. UNIT (2/2)

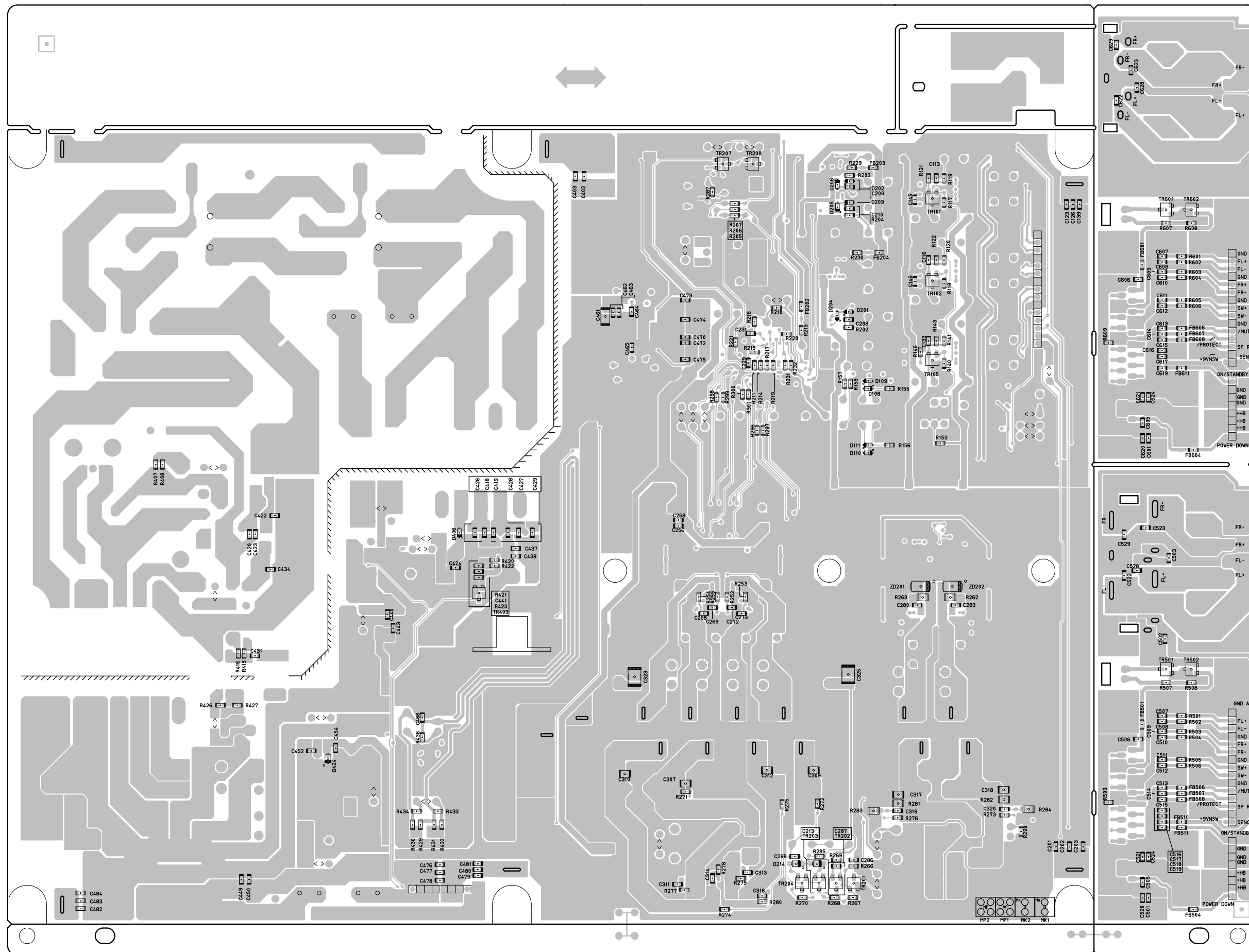

FOIL SIDE

1U-3777 ETHERNET P.W.B. UNIT

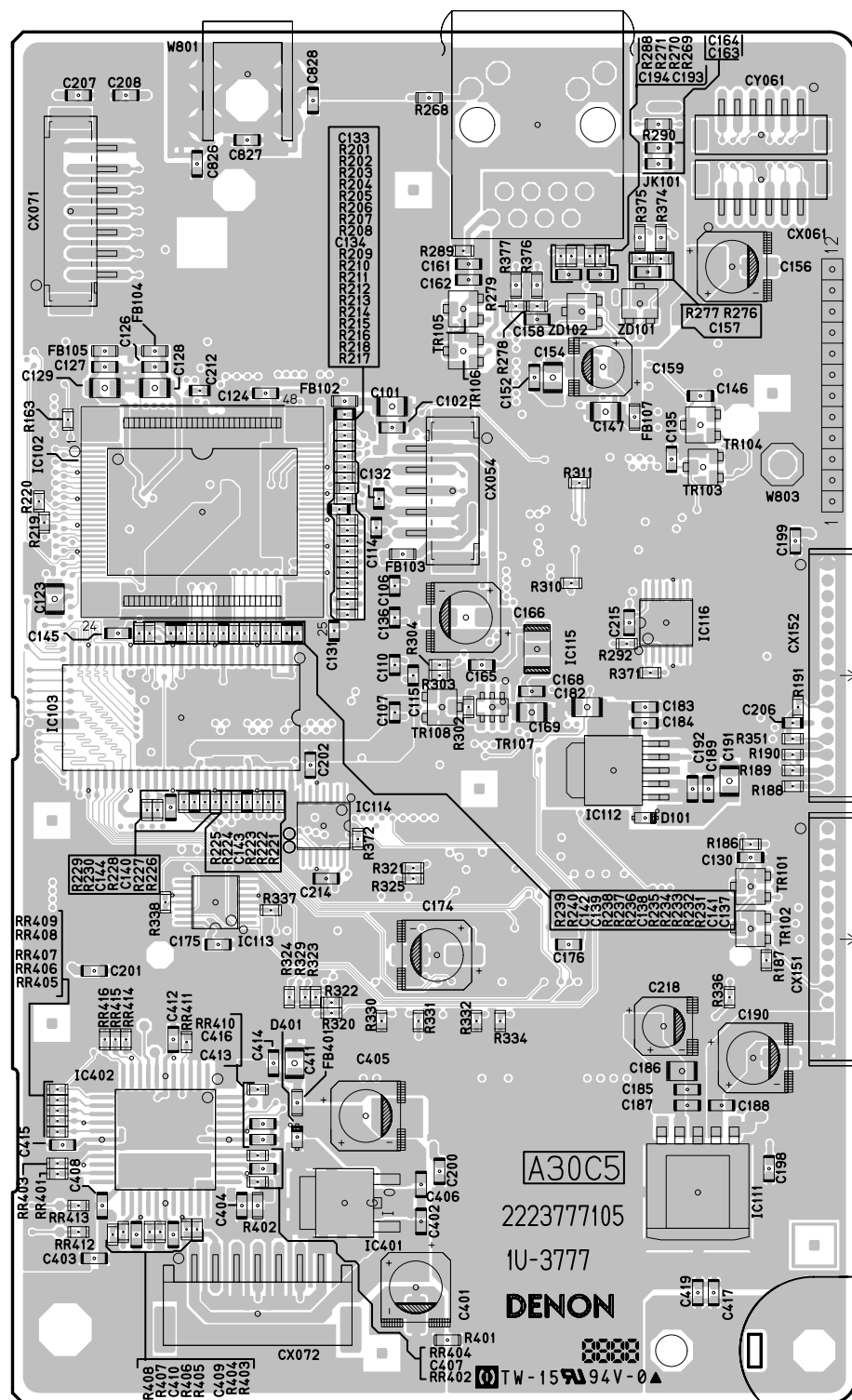

COMPONENT SIDE

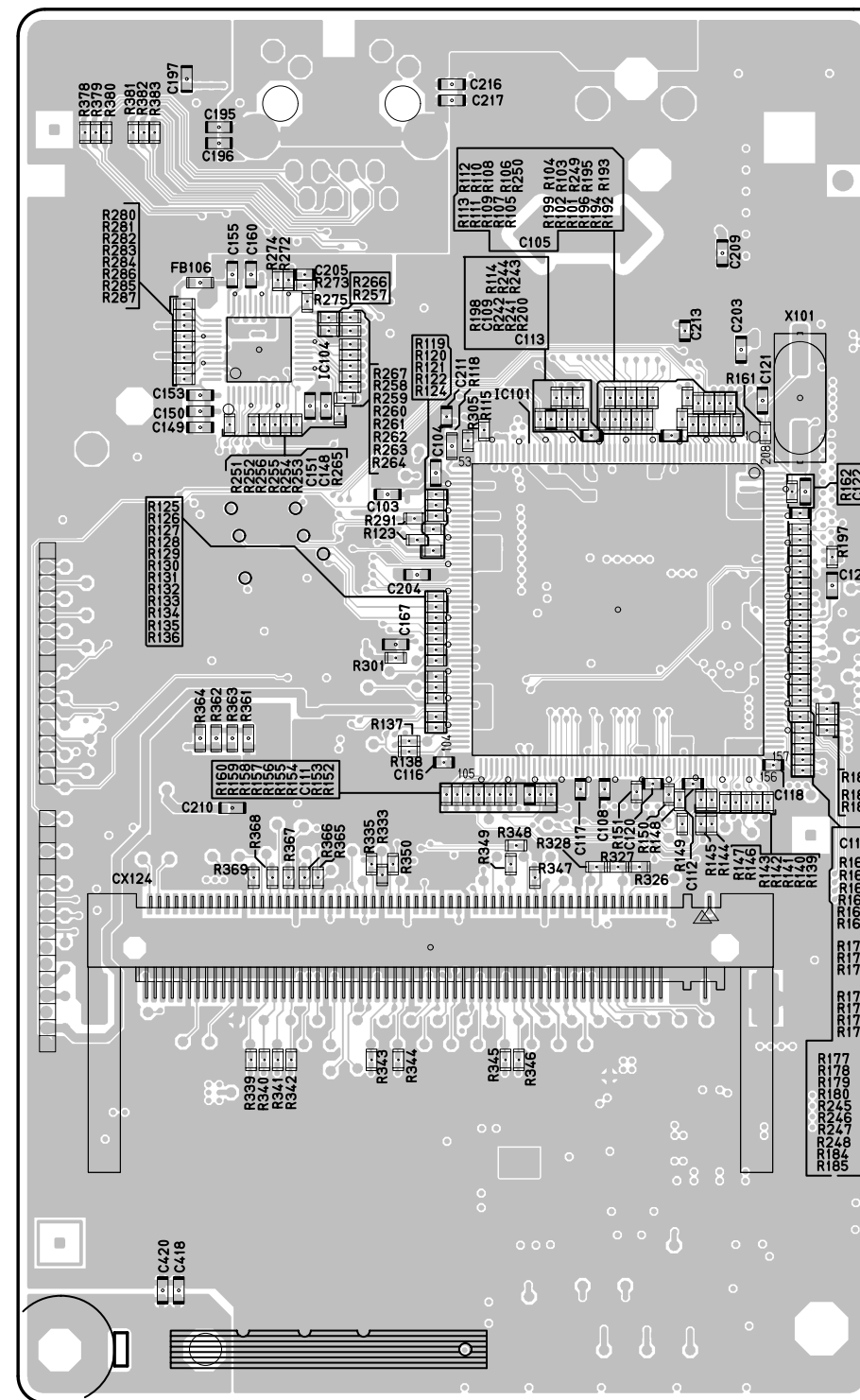

FOIL SIDE

1U-3807 FEP P.W.B. UNIT

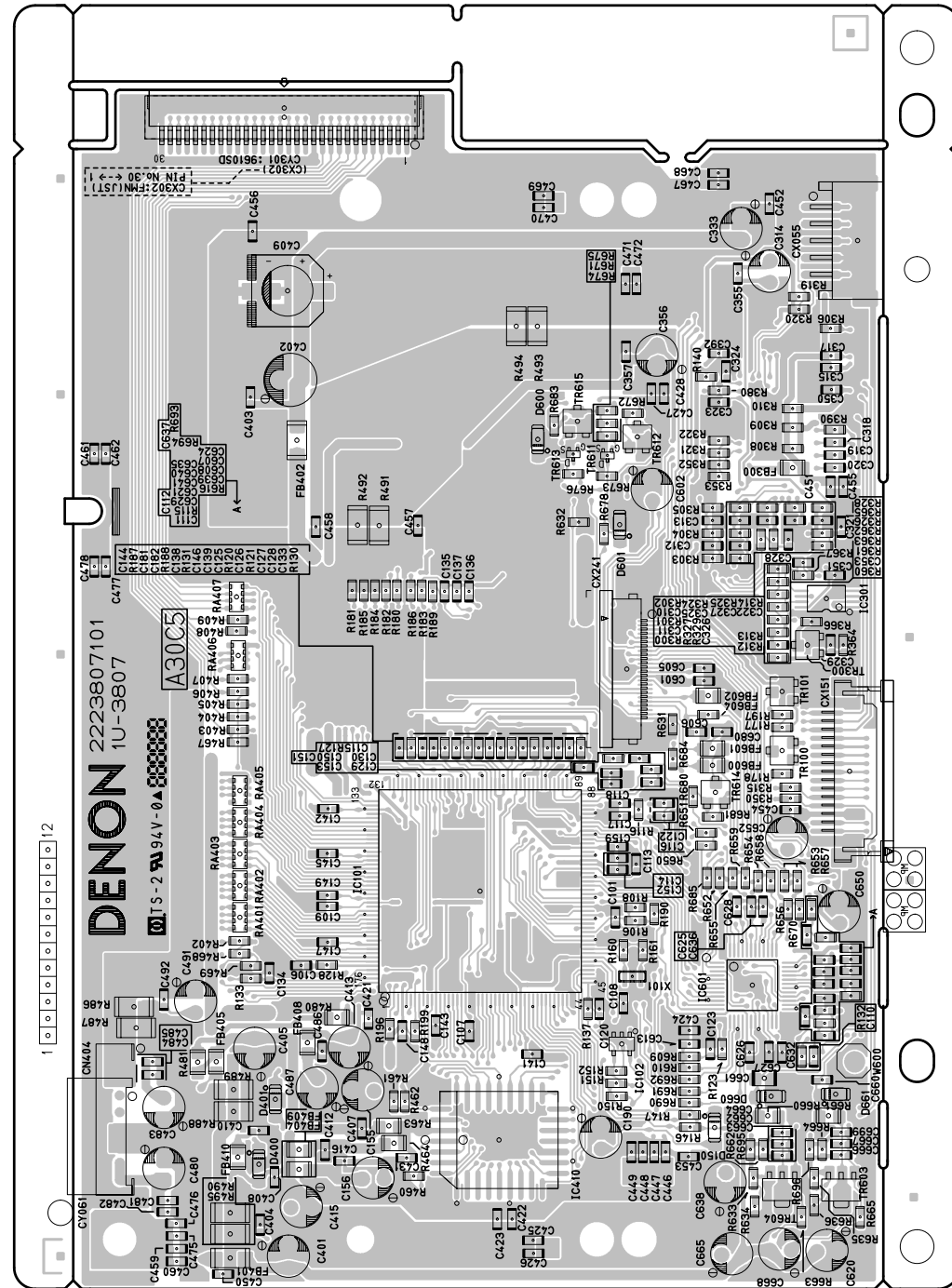

COMPONENT SIDE

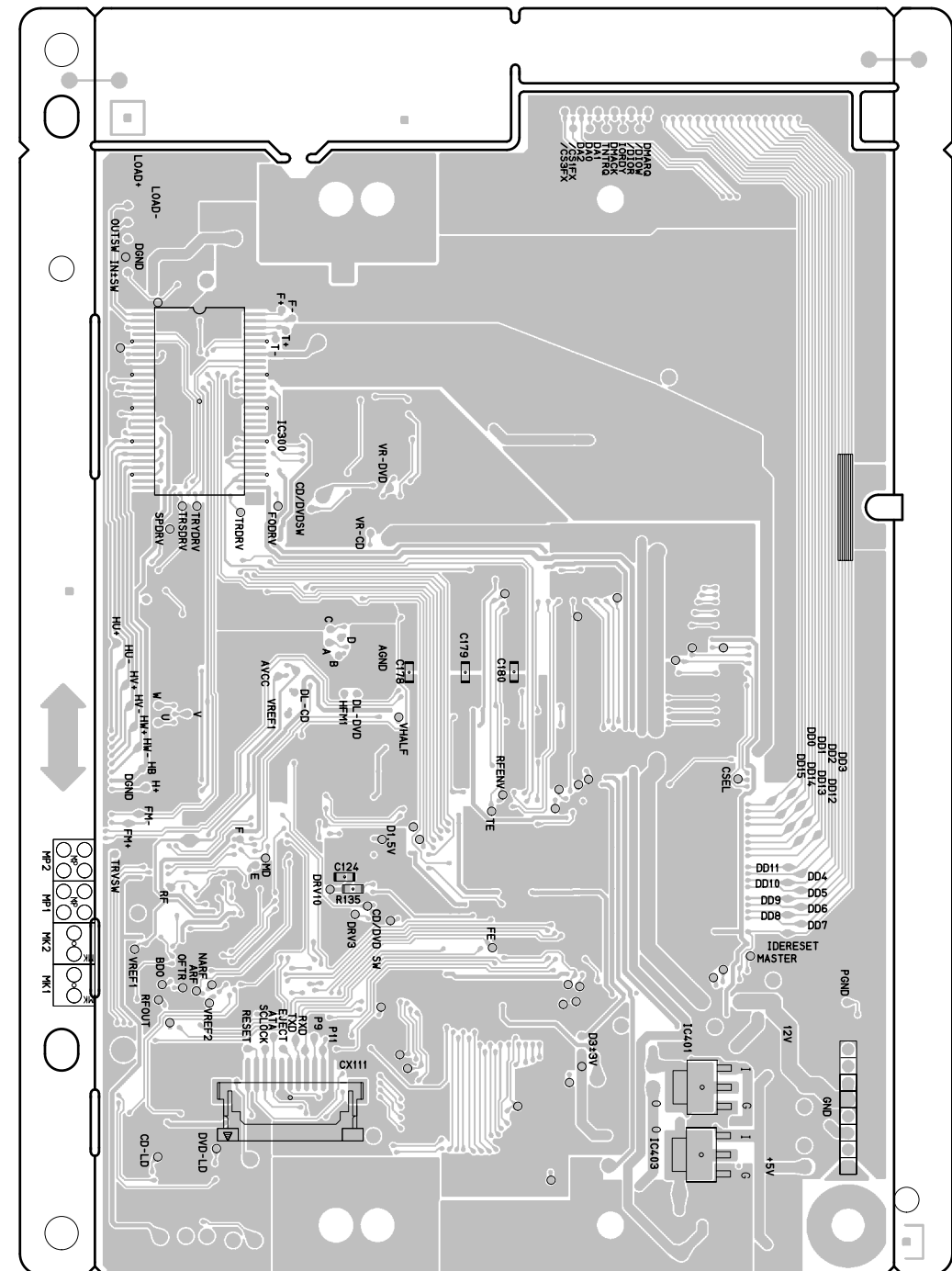

FOIL SIDE

# NOTE FOR PARTS LIST

- Parts for which "nsp" is indicated on this table cannot be supplied.
  - When ordering of part, clearly indicate "1" and "I" (i) to avoid mis-supplying.
  - Ordering part without stating its part number can not be supplied.
  - Part indicated with the mark "★" is not illustrated in the exploded view.
  - Not including General-purpose Carbon Film Resistor in the P.W.Board parts list. (Refer to the Schematic Diagram for those parts.)
  - Not including General-purpose Carbon Chip Resistor in the P.W.Board parts list. (Refer to the Schematic Diagram for those parts.)
- WARNING:**  
Parts marked with this symbol  $\triangle$  have critical characteristics. Use ONLY replacement parts recommended by the manufacturer.

## ● Resistors

Ex.: RN 14K 2E 182 G FR

Type	Shape and performance	Power	Resistance	Allowable error	Others
RD : Carbon RC : Composition RS : Metal oxide film RW : Winding RN : Metal film RK : Metal mixture	2B : 1/8W 2E : 1/4W 2H : 1/2W 3A : 1W 3D : 2W 3F : 3W 3H : 5W	F : ±1% G : ±2% J : ±5% K : ±10% M : ±20%	P : Pulse-resistant type NL : Low noise type NB : Non-burning type FR : Fuse-resistor F : Lead wire forming		

### \* Resistance

- 1 8 2 ⇒ 1800 ohm = 1.8 kohm  
Indicates number of zeros after effective number.  
2-digit effective number.
- Units: ohm
- 1 R 2 ⇒ 1.2 ohm  
1-digit effective number.  
2-digit effective number, decimal point indicated by R.
- Units: ohm

## ● Capacitors

Ex.: CE 04W 1H 2R2 M BP

Type	Shape and performance	Dielectric strength	Capacity	Allowable error	Others
CE : Aluminum foil electrolytic CA : Aluminum solid electrolytic CS : Tantalum electrolytic CQ : Film CK : Ceramic CC : Ceramic CP : Oil CM : Mica CF : Metallized CH : Metallized	0J : 6.3V 1A : 10V 1C : 16V 1E : 25V 1V : 35V 1H : 50V 2A : 100V 2B : 125V 2C : 160V 2D : 200V 2E : 250V 2H : 500V 2J : 630V	F : ±1% G : ±2% J : ±5% K : ±10% M : ±20% Z : +80% -20% P : +100% -0% C : ±0.25pF D : ±0.5pF = : Others	HS : High stability type BP : Non-polar type HR : Ripple-resistant type DL : For change and discharge HF : For assuring high frequency U : UL part C : CSA part W : UL-CSA type F : Lead wire forming		

### \* Capacity (electrolyte only)

- 2 2 2 ⇒ 2200μF  
Indicates number of zeros after effective number.  
2-digit effective number.
- Units: μF.
- 2 R 2 ⇒ 2.2μF  
1-digit effective number.  
2-digit effective number, decimal point indicated by R.
- Units: μF.
- \* Capacity (except electrolyte)
- 2 2 2 ⇒ 2200pF=0.0022μF  
(More than 2) — Indicates number of zeros after effective number.  
2-digit effective number.
- Units: pF.
- 2 2 1 ⇒ 220pF  
(0 or 1) — Indicates number of zeros after effective number.  
2-digit effective number.
- Units: pF.

When the dielectric strength is indicated in AC, "AC" is included after the dielectric strength value.

# 部品表について

- 部品表に "nsp" と記載されている部品は供給できません。
- 部品を発注する際は特に数字の "1" と英字の "I" との区別をはっきり記入してください。
- 部品番号を表示していない部品は供給できません。
- $\triangle$ 印の部品は安全上重要な部品です。交換するときは、安全および性能維持のため必ず指定の部品をご使用ください。
- ★印のついている部品は分解図中には記載していません。
- 汎用カーボン抵抗器は記載していません。定数は回路図を参照願います。
- 汎用カーボンチップ抵抗器は記載していません。定数は回路図を参照願います。
- 部品表の抵抗器、コンデンサの品名記号の読み方は表を参照してください。

## ● 抵抗器

例) RN 14K 2E 182 G FR

RN 種類	14K 形状特性	2E 電力	182 抵抗値	G 許容差	FR その他
RD : カーボン RC : 固定体 RS : 金属系皮膜 RW : 巻線 RN : 金属皮膜 RK : 金属混合体	2B : 1/8 W 2E : 1/4 W 2H : 1/2 W 3A : 1 W 3D : 2 W 3F : 3 W 3H : 5 W	F : ±1% G : ±2% J : ±5% K : ±10% M : ±20%	P : 耐パルス形 NL : 低雑音形 NB : 不燃形 FR : ヒューズ抵抗 F : リード線成形		

### \* 抵抗値

- 18 2 ⇒ 1800Ω=1.8kΩ  
有効数字につづく0の数を表わす。  
2桁の有効数字を表わす。
- 1R 2 ⇒ 1.2Ω  
1桁の有効数字を表わす。  
2桁の有効数字で小数点はRで表わす。
- 単位はΩ

## ● コンデンサ

例) CE 04W 1H 2R2 M BP

CE 種類	04W 形状特性	1H 耐圧	2R2 容量	M 許容差	BP その他
CE : アルミ箔電解 CA : アルミ固体電解 CS : タンタル電解 CQ : フィルム CK : セラミック CP : オイル CM : マイカ CF : メタライズド CH : メタライズド	0J : 6.3 V 1A : 10 V 1C : 16 V 1E : 25 V 1V : 35 V 1H : 50 V 2A : 100 V 2B : 125 V 2C : 160 V 2D : 200 V 2E : 250 V 2H : 500 V 2J : 630 V	F : ±1% G : ±2% J : ±5% K : ±10% M : ±20% Z : +80% -20% P : +100% -0% C : ±0.25pF D : ±0.5pF = : その他	HS : 高安定形 BP : 無極性形 HR : 耐リップル形 DL : 充放電対策用 HF : 高周波保証用 U : UL 部品 C : CSA 部品 W : UL-CSA 部品 F : リード線成形		

### \* 容量値

#### ● 電解コンデンサの場合

- 22 2 ⇒ 2200μF  
有効数字につづく0の数を表わす。  
2桁の有効数字を表わす。  
単位はμF
- 2R 2 ⇒ 2.2μF  
1桁の有効数字を表わす。  
2桁の有効数字で小数点はRで表わす。  
単位はμF

#### ● 電解コンデンサ以外の場合

- 22 2 ⇒ 2200pF=0.0022μF  
有効数字につづく0の数を表わす。  
(0の数が2以上の場合)  
2桁の有効数字を表わす。  
単位はpF
- 22 1 ⇒ 220pF  
有効数字につづく0の数を表わす。  
(0の数が0または1の場合)  
2桁の有効数字を表わす。  
単位はpF

#### ● 耐圧を交流で表示する場合は、耐圧表示の次に「AC」を表示します。

## PARTS LIST OF P.W.B. UNIT

\* 本表に "nsp" と記載されている部品は供給できません。

\* Parts for which "nsp" is indicated on this table cannot be supplied.

\* 本表に記載されている部品は、補修用部品のため製品に使用している部品とは一部、形状、寸法などが異なる場合があります。

\* The parts listed below are for maintenance only, might differ from the parts used in the unit in appearances or dimensions.

**Note:** The symbols in the column "Remarks" indicate the following destinations.

E3 : U.S.A. & Canada model

E2 : Europe model

JP : Japan model

### 1U-3777A ETHERNET P.W.B. UNIT ASS'Y

Ref. No.	Part No.	Part Name	Remarks	Q'ty	New
<b>SEMICONDUCTORS GROUP</b>					
IC101	nsp	BCOIC-DM850E-CQL			
IC102	00D GEN 8631	DM850 ROM ASSY	S29GL064A90TFIR40		*
IC103	00D 262 3685 004	W9812G6GH-6			
IC104	00D 262 3712 003	RTL8201CP			
IC105	00D 262 3522 905	MIC2025-1YM			
IC111	00D 263 1290 902	BA33DD0WHFP			*
IC112	00D 263 1110 901	PQ070XZ01ZP +C			
IC113	00D 262 2516 909	SN74LV32APW-EL2 +C			
IC114	00D 262 3412 905	TC74VHC14FT			
IC115	00D 279 0055 907	MICROSMD175F			
IC116	00D 262 2516 909	SN74LV32APW-EL2 +C			
IC402	00D 262 3711 004	SAA7121H			
TR101	00D 269 0193 901	KRC104S-RTK/P (47K-47K)			
TR102	00D 269 0184 907	KRA102S-RTK/P (10K-10K)			
TR105,106	00D 269 0192 902	KRC102S-RTK/P (10K-10K)			
TR107	00D 275 7001 907	FDC608PZ			
TR108	00D 269 0192 902	KRC102S-RTK/P (10K-10K)			
D401	00D 276 0750 902	RB521S-30TE61 +REF			
ZD101,102	00D 276 0837 906	NSAD500F-T1B-A			
<b>RESISTORS GROUP</b>					
R118	nsp	RM73B--6041DT(1608)			
R361	nsp	RM73B--511FT +1608			
R364	nsp	RM73B--102FT +1608			
<b>CAPACITORS GROUP</b>					
C101	00D 257 0039 907	CK73B0J106MT			
C102,103	nsp	CK73F1E104ZT +1608			
C104	nsp	CK73F1H103ZT +1608			
C105-108	nsp	CK73F1C104ZT +1005			
C109-112	nsp	CK73B1H102KT +1005			
C113-116	nsp	CK73B1A104KT +1005			
C117-120	nsp	CK73B1H102KT +1005			
C123	00D 257 0039 907	CK73B0J106MT			
C124	nsp	CK73B1H102KT +1608			
C125	nsp	CK73F1E104ZT +1608			
C126,127	nsp	CK73F1H103ZT +1608			
C128,129	00D 257 0039 907	CK73B0J106MT			
C130	nsp	CK73B1H102KT +1608			
C131,132	nsp	CK73F1C104ZT +1005			
C133,134	nsp	CK73B1H102KT +1005			
C135	nsp	CK73F1E104ZT +1608			

	Ref. No.	Part No.	Part Name	Remarks	Q'ty	New
	C136-141	nsp	CK73F1C104ZT +1005			
	C142,143	nsp	CK73B1H102KT +1005			
	C147	nsp	CK73B1E104KT +2125			
	C148-150	nsp	CK73F1E104ZT +1608			
	C151-153	nsp	CK73B1H102KT +1608			
	C154	00D 257 0039 907	CK73B0J106MT			
	C155	nsp	CK73F1E104ZT +1608			
	C156	00D 254 4738 904	CE67W0J101MT(GV)			
	C157,158	nsp	CK73F1E104ZT +1608			
	C159	00D 254 4740 905	CE67W1C220MT(GV)			
	C160	nsp	CK73F1E104ZT +1608			
	C161	nsp	CK73B1H102KT +1608			
	C162	nsp	CK73F1E104ZT +1608			
	C163	nsp	CK73B1H102KT +1608			
	C164,165	nsp	CK73F1E104ZT +1608			
	C166	00D 254 4738 904	CE67W0J101MT(GV)			
	C167,168	nsp	CK73F1E104ZT +1608			
	C169	00D 257 0039 907	CK73B0J106MT			
	C174	00D 254 4738 904	CE67W0J101MT(GV)			
	C175	nsp	CK73F1E104ZT +1608			
	C176	nsp	CK73B1H102KT +1608			
	C182	00D 257 0039 907	CK73B0J106MT			
	C183	nsp	CK73B1H102KT +1608			
	C184	nsp	CC73CH1H101JT +1608			
	C185	nsp	CK73B1H102KT +1608			
	C186	00D 257 0039 907	CK73B0J106MT			
	C187	nsp	CC73CH1H101JT +1608			
	C189	nsp	CK73B1H102KT +1608			
	C190	00D 254 4738 904	CE67W0J101MT(GV)			
	C191	00D 257 0039 907	CK73B0J106MT			
	C192	nsp	CC73CH1H101JT +1608			
	C193,194	nsp	CK73B1E104KT +1608			
	C195	nsp	CK73B1H102KT +1608			
	C196	nsp	CK73B1E104KT +1608			
	C197-204	nsp	CC73CH1H100DT +1608			
	C205,206	nsp	CC73CH1H100DT +1005			
	C207-210	nsp	CC73CH1H100DT +1608			
	C211-213	nsp	CC73CH1H100DT +1005			
	C214-216	nsp	CK73F1E104ZT +1608			
	C217	nsp	CK73F1H103ZT +1608			
	C218	00D 254 4740 905	CE67W1C220MT(GV)			
	C405	00D 254 4740 934	CE67W1C101MT(GV)			
	C406-410	nsp	CK73B1E104KT +1608			
	C411	00D 257 0039 907	CK73B0J106MT			
	C412-415	nsp	CK73B1E104KT +1608			
	C416	nsp	CK73B1H102KT +1608			
	C417	nsp	CK73F1E104ZT +1608			
	C418	nsp	CK73F1H103ZT +1608			
	C419	nsp	CK73B1H102KT +1608			
	C826	nsp	CK73F1E104ZT +1608			
	C827	nsp	CK73F1H103ZT +1608			
	C828	nsp	CK73B1H102KT +1608			



	Ref. No.	Part No.	Part Name	Remarks	Q'ty	New
<b>OTHERS PARTS GROUP</b>						
	CX054	nsp	5P PH CON BASE(TAPE) +REF			
	CX072	nsp	7P PH CON.BASE(L) +REF			
	CX124	00D 205 1434 005	MINI-PCI-CONNECTOR			
	CX151	nsp	15P SOCKET(9120)			
	FB102-107	nsp	CHIP EMIFIL(11A121) +1608			
	FB401	nsp	CHIP EMIFIL(11A121) +1608			
	JK101	00D 205 1333 009	8P MODULAR			
	W801	nsp	M3 SCREW TERMINAL			

## 1U-3808A/B/C MAIN P.W.B. UNIT ASS'Y

Ref. No.	Part No.	Part Name	Remarks	Q'ty	New
<b>SEMICONDUCTORS GROUP</b>					
IC101	00D 262 3708 004	ES6178FF			
IC102	00D GEN 8629	S302 B/E ROM ASSY	ES29LV160EB-70TGI		
IC103	00D 262 3759 008	K4S641632K-UC60			*
IC104	00D 262 3402 902	BR24L32F-WE2 +C			
IC105	00D 262 3242 900	SN74LV273APW-EL2 +REF			
IC108	00D 262 2516 909	SN74LV32APW-EL2 +C			
IC109	00D 262 3751 909	BU2360FV-FE2			*
IC110	00D 262 3046 902	TC7WH157FU +C			
IC111	00D 263 1110 901	PQ070XZ01ZP +C			
IC112	00D 262 2515 900	SN74LV04APW-EL2 +C			
IC201	00D GEN 8627	S302 SYSTEM ROM ASSY	M3087BFKBGP		
IC202	00D 262 3707 908	BR25L640F-WE2			
IC203	00D 262 3082 924	BD4730G-TR			
IC205	00D 262 2953 902	SN74HCT244APW +C			
IC209	00D 262 2517 908	SN74LV08APW-EL2 +REF			
IC210	00D 262 2813 903	SN74AHCT08PW-EL2 +C			
IC211	00D 262 2517 908	SN74LV08APW-EL2 +REF			
IC301	00D GEN 8628	S302 SUB ROM ASSY	M30627FHPPG		
IC302	00D 262 2745 903	BU2090F(E2) +C			
IC303	00D 263 1240 907	BA33B00FP-E2			
IC304	00D 263 1278 908	SI-8001FDE			*
IC305	00D 263 1279 907	SI-8008TM			*
IC306	00D 263 1278 908	SI-8001FDE			*
IC401	00D 262 3709 003	ADSP21367KSZ1A1138			
IC402	00D 262 3746 008	W9864G2GH-7			
IC403	00D GEN 8630	DSP ROM ASSY	ES29LV160EB-70TGI		*
IC404	00D 263 1281 908	BD9130NV-E2			*
IC501	00D 262 3757 000	ADAU1328BSTZ1138			*
IC502	00D 262 3449 004	LC89057W-VF4A			
IC503	00D 262 3750 007	LC4064V-75TN100C(S302)			*
IC504,505	00D 263 0934 900	BA4510F-E2 +C			
IC506,507	00D 263 0896 909	NJM2068MD-TE1 +C			
IC508	00D 262 2977 946	BA33BC0FP-E2 +REF			
IC509	00D 262 3077 900	TC74VHCU04FT +REF			
IC510	00D 269 0230 000	GP1FAV31TK0F			
IC511	00D 269 0231 009	GP1FAV31RK0F			
IC601	00D 263 1245 009	M61531FP			
IC602	00D 263 1232 902	NJM79L07UA-TE1			
IC603	00D 263 1231 903	NJM78L07UA-TE1			
IC604,605	00D 263 1292 900	UTC4558E			*
IC608	00D 263 0995 004	NJM4556AD +T			
IC609,610	00D 263 0615 902	BA15218F-DXE2 +C			
IC611-613	00D 263 1277 909	RC4580IDR			
TR201	00D 274 0188 905	2SD1858TV2(Q/R)			
TR202	00D 269 0184 907	KRA102S-RTK/P (10K-10K)			
TR204	00D 269 0192 902	KRC102S-RTK/P (10K-10K)			
TR205	00D 271 0238 908	2SA1037KT146S +C			
TR206	00D 269 0192 902	KRC102S-RTK/P (10K-10K)			
TR207,208	00D 275 0100 902	2SK771-5-TB			
TR209	00D 269 0184 907	KRA102S-RTK/P (10K-10K)			
TR210	00D 269 0192 902	KRC102S-RTK/P (10K-10K)			
TR211,212	00D 273 0488 000	2SC4614 (HFE S/T)			
TR213	00D 275 0117 908	RSQ035P03-TR			

	Ref. No.	Part No.	Part Name	Remarks	Q'ty	New
	TR214	00D 269 0192 902	KRC102S-RTK/P (10K-10K)			
	TR215	00D 273 0384 900	2SC2412KT96(S) +C			
	TR216	00D 269 0192 902	KRC102S-RTK/P (10K-10K)			
	TR301-303	00D 269 0192 902	KRC102S-RTK/P (10K-10K)			
	TR501-503	00D 273 0460 905	KTC2875-B-RTK/P			
	TR504	00D 269 0192 902	KRC102S-RTK/P (10K-10K)			
	TR505	00D 269 0184 907	KRA102S-RTK/P (10K-10K)			
	TR601-604	00D 273 0460 905	KTC2875-B-RTK/P			
	TR605	00D 273 0384 900	2SC2412KT96(S) +C			
	TR606,607	00D 269 0184 907	KRA102S-RTK/P (10K-10K)			
	TR608	00D 269 0192 902	KRC102S-RTK/P (10K-10K)			
	TR609	00D 273 0384 900	2SC2412KT96(S) +C			
	TR610,611	00D 269 0184 907	KRA102S-RTK/P (10K-10K)			
	TR612	00D 269 0192 902	KRC102S-RTK/P (10K-10K)			
	TR613-617	00D 273 0460 905	KTC2875-B-RTK/P			
	TR618	00D 269 0184 907	KRA102S-RTK/P (10K-10K)			
	TR619	00D 269 0192 902	KRC102S-RTK/P (10K-10K)			
	D101	00D 276 0794 900	KDS160-RTK/P			
	D201,202	00D 276 0794 900	KDS160-RTK/P			
	D204,205	00D 276 0794 900	KDS160-RTK/P			
	D206	00D 276 0560 901	DAN202KT146 +C			
	D207-209	00D 276 0750 902	RB521S-30TE61 +REF			
	D210-213	00D 276 0401 905	1SS133T77 (TAPE)			
	D214,215	00D 276 0750 902	RB521S-30TE61 +REF			
	D301	00D 276 0825 905	SFPB-74V			
	D302	00D 276 0824 906	SFPB-64V			
	D303	00D 276 0825 905	SFPB-74V			
	D401	00D 276 0750 902	RB521S-30TE61 +REF			
	D501,502	00D 276 0750 902	RB521S-30TE61 +REF			
	D506,507	00D 276 0794 900	KDS160-RTK/P			
	D601	00D 276 0750 902	RB521S-30TE61 +REF			
	D604	00D 276 0750 902	RB521S-30TE61 +REF			
	D609,610	00D 276 0560 901	DAN202KT146 +C			
	D613	00D 276 0560 901	DAN202KT146 +C			
	D614	00D 276 0559 909	DAP202KT146 +C			
	D615	00D 276 0560 901	DAN202KT146 +C			
	D616	00D 276 0559 909	DAP202KT146 +C			
	ZD201	00D 276 0683 914	UDZS9.1B-TE17 +C			
	ZD205	00D 276 0760 989	MTZJ7.5B T77			
<b>RESISTORS GROUP</b>						
	R219	nsp	RM73B--122FT +1608			
	R220	nsp	RM73B--102FT +1608			
	R221	nsp	RM73B--122FT +1608			
	R387,388	00D 244 2688 907	RS14B3A1R2JNBST(S)			
	R452,453	00D 241 2313 901	RD14B2E101GFRST			
	R846	00D 244 2051 974	RS14B3A102JNBST(S)			
<b>CAPACITORS GROUP</b>						
	C101,102	00D 257 2018 900	CS77B1A100MT(NOJ)			
	C103-105	nsp	CK73F1C104ZT +1005			
	C107	nsp	CK73F1H103ZT +1005			

	Ref. No.	Part No.	Part Name	Remarks	Q'ty	New
	C108	nsp	CK73F1C104ZT +1005			
	C110	00D 254 4739 916	CE67W1A470MT(GV)			
	C111	nsp	CK73F1C104ZT +1005			
	C112	00D 254 4739 916	CE67W1A470MT(GV)			
	C113-121	nsp	CK73F1C104ZT +1005			
	C122	00D 254 4739 916	CE67W1A470MT(GV)			
	C123-133	nsp	CK73F1C104ZT +1005			
	C134	nsp	CK73F1E104ZT +1608			
	C137	00D 254 4739 916	CE67W1A470MT(GV)			
	C138	nsp	CK73B1H102KT +1005			
	C139	nsp	CK73F1C104ZT +1005			
	C140	nsp	CK73F1H103ZT +1005			
	C141	00D 254 4739 916	CE67W1A470MT(GV)			
	C142-148	nsp	CK73F1C104ZT +1005			
	C149	nsp	CK73F1H103ZT +1608			
	C150	nsp	CK73F1E104ZT +1608			
	C151	nsp	CK73B1H102KT +1608			
	C153	nsp	CK73F1E104ZT +1608			
	C154	00D 254 4739 916	CE67W1A470MT(GV)			
	C155	nsp	CC73CH1H7R0DT +1608			
	C156	nsp	CK73F1E104ZT +1608			
	C157	nsp	CC73CH1H7R0DT +1608			
	C158	nsp	CK73F1H103ZT +1608			
	C159	nsp	CK73F1E104ZT +1608			
	C160	nsp	CK73B1H102KT +1608			
	C161	nsp	CK73F1H103ZT +1608			
	C162	nsp	CK73F1E104ZT +1608			
	C163	nsp	CK73B1H102KT +1608			
	C166	nsp	CK73F1E104ZT +1608			
	C167,168	nsp	CK73B1H102KT +1608			
	C169	nsp	CK73F1E104ZT +1608			
	C170	00D 254 4739 916	CE67W1A470MT(GV)			
	C171,172	nsp	CK73F1E104ZT +1608			
	C173	00D 254 4739 916	CE67W1A470MT(GV)			
	C180	nsp	CK73F1E104ZT +1608			
	C192	nsp	CK73F1E104ZT +1608			
	C193	nsp	CK73B1H102KT +1608			
	C194,195	nsp	CK73F1E104ZT +1608			
	C201	nsp	CK73F1E104ZT +1608			
	C207	nsp	CK73F1E104ZT +1608			
	C208	nsp	CK73B1H102KT +1608			
	C210	00D 254 4739 916	CE67W1A470MT(GV)			
	C211-215	nsp	CK73F1E104ZT +1608			
	C218,219	nsp	CK73F1E104ZT +1608			
	C220	00D 254 4739 916	CE67W1A470MT(GV)			
	C221	00D 254 4740 976	CE67W1C100MT(GV)			
	C222	nsp	CK73F1E104ZT +1608			
	C223	nsp	CK73B1H102KT +1608			
	C224	nsp	CK73F1E104ZT +1608			
	C226	nsp	CK73F1E104ZT +1608			
	C234	nsp	CK73F1E104ZT +1608			
	C237,238	nsp	CK73F1E104ZT +1608			
	C241-243	nsp	CK73F1E104ZT +1608			
	C246	nsp	CK73F1H103ZT +1608			
	C247,248	nsp	CK73F1E104ZT +1608			
	C249	nsp	CK73B1H102KT +1608			

	Ref. No.	Part No.	Part Name	Remarks	Q'ty	New
	C251	nsp	CK73F1E104ZT +1608			
	C252	nsp	CK73B1H102KT +1608			
	C254	nsp	CK73F1E104ZT +1608			
	C255	nsp	CK73B1H102KT +1608			
	C256,257	nsp	CK73F1E104ZT +1608			
	C260-262	nsp	CK73F1E104ZT +1608			
	C263	nsp	CK73F1H103ZT +1608			
	C264	nsp	CK73B1H102KT +1608			
	C265,266	nsp	CK73F1E104ZT +1608			
	C276	nsp	CK73F1E104ZT +1608			
	C277	nsp	CK73B1H102KT +1608			
	C278	00D 254 4740 934	CE67W1C101MT(GV)			
	C279	nsp	CK73F1E104ZT +1608			
	C281	nsp	CK73F1H103ZT +1608			
	C282	00D 254 4756 902	CE04W1H101MT HB5(KY)			
	C283	nsp	CK73F1E104ZT +1608			
	C284,285	nsp	CK73F1H473ZT +1608			
	C286	00D 255 1278 907	CQ93M2D562JT(B)			
	C287	00D 254 4713 916	CE04W1E470MT E11(KY)			
	C291	00D 254 4743 944	CE67W1H010MT(GV)			
	C292	nsp	CK73F1E104ZT +1608			
	C293	00D 254 4740 976	CE67W1C100MT(GV)			
	C294	nsp	CK73F1E104ZT +1608			
	C301	nsp	CK73F1E104ZT +1608			
	C302	nsp	CK73F1H103ZT +1608			
	C303	nsp	CK73F1E104ZT +1608			
	C304	00D 254 4740 921	CE67W1C470MT(GV)			
	C305	nsp	CK73F1E104ZT +1608			
	C306	nsp	CK73B1H102KT +1608			
	C307	00D 254 4740 921	CE67W1C470MT(GV)			
	C308	nsp	CK73F1E104ZT +1608			
	C311	nsp	CK73F1E104ZT +1608			
	C312	nsp	CK73B1H102KT +1608			
	C313-317	nsp	CK73F1E104ZT +1608			
	C318,319	nsp	CK73F1H103ZT +1608			
	C320	nsp	CK73F1E104ZT +1608			
	C321-323	nsp	CK73F1H103ZT +1608			
	C324,325	00D 254 4740 976	CE67W1C100MT(GV)			
	C326	00D 254 4739 916	CE67W1A470MT(GV)			
	C327	nsp	CK73F1H103ZT +1608			
	C328	00D 254 4739 916	CE67W1A470MT(GV)			
	C329,330	nsp	CK73F1H103ZT +1608			
	C331	00D 254 4740 921	CE67W1C470MT(GV)			
	C332	00D 254 4740 976	CE67W1C100MT(GV)			
	C333	00D 254 4743 986	CE67W1H100MT(GV)			
	C361	00D 254 4709 700	CE04W1V221MC JC5(KY)			
	C362	00D 257 1020 915	CK73B1H225KT			
	C363	nsp	CK73B1E104KT +1608			
	C365	nsp	CK73F1E104ZT +1608			
	C366	00D 254 4711 905	CE04W1A471MT HB5(KY)			
	C367	00D 254 4709 700	CE04W1V221MC JC5(KY)			
	C368	00D 257 1020 915	CK73B1H225KT			
	C369	nsp	CK73B1E104KT +1608			
	C371	nsp	CK73F1E104ZT +1608			
	C372	00D 254 4711 905	CE04W1A471MT HB5(KY)			
	C373	00D 254 4709 700	CE04W1V221MC JC5(KY)			

	Ref. No.	Part No.	Part Name	Remarks	Q'ty	New
	C374	00D 257 1020 915	CK73B1H225KT			
	C375	nsp	CK73B1E104KT +1608			
	C377	nsp	CK73F1E104ZT +1608			
	C378	00D 254 4712 700	CE04W1C471MC JC5(KY)			
	C379	nsp	CK73F1E104ZT +1608			
	C380	nsp	CK73B1H102KT +1608			
	C401	nsp	CK73F1C104ZT +1005			
	C402-409	nsp	CK73F1H103ZT +1005			
	C410-415	nsp	CC73CH1H101JT +1005			
	C416-420	nsp	CK73B1H102KT +1005			
	C421	00D 257 2018 900	CS77B1A100MT(NOJ)			
	C422	nsp	CC73CH1H101JT +1005			
	C423	nsp	CK73F1H103ZT +1005			
	C424	nsp	CK73B1H102KT +1005			
	C425,426	nsp	CK73F1C104ZT +1005			
	C427	00D 257 2018 900	CS77B1A100MT(NOJ)			
	C428	nsp	CK73B1H102KT +1005			
	C429	nsp	CK73F1C104ZT +1005			
	C430	nsp	CK73B1H102KT +1005			
	C431	nsp	CK73F1C104ZT +1005			
	C432	00D 257 0039 910	CK73B0J226MT			
	C433	nsp	CK73B1H102KT +1608			
	C434	nsp	CK73B1A106KT +2125			
	C435	nsp	CK73F1C104ZT +1005			
	C436-446	nsp	CK73F1H103ZT +1005			
	C447,448	nsp	CK73F1C104ZT +1005			
	C449,450	nsp	CC73CH1H8R0DT +1608			
	C451,452	nsp	CK73F1C104ZT +1005			
	C453,454	00D 257 2018 900	CS77B1A100MT(NOJ)			
	C501	nsp	CK73F1E104ZT +1608			
	C502	nsp	CK73B1H102KT +1608			
	C503	nsp	CK73B1E223KT +1608			
	C504	00D 254 4740 921	CE67W1C470MT(GV)			
	C505	nsp	CK73F1E104ZT +1608			
	C506,507	nsp	CK73F1H103ZT +1608			
	C508	nsp	CK73F1E104ZT +1608			
	C509	00D 254 4740 976	CE67W1C100MT(GV)			
	C510	00D 254 4742 916	CE67W1V100MT(GV)			
	C511,512	nsp	CK73F1E104ZT +1608			
	C513	00D 254 4740 976	CE67W1C100MT(GV)			
	C514,515	nsp	CK73F1H103ZT +1608			
	C517	00D 254 4740 921	CE67W1C470MT(GV)			
	C518	nsp	CK73F1E104ZT +1608			
	C520	nsp	CK73B1H562KT +1608			
	C521	nsp	CC73CH1H391JT +1608			
	C523	00D 254 4740 921	CE67W1C470MT(GV)			
	C524	nsp	CK73F1H103ZT +1608			
	C525	nsp	CK73F1E104ZT +1608			
	C526	nsp	CK73B1H102KT +1005			
	C527	nsp	CK73F1E104ZT +1608			
	C528	nsp	CC73CH1H121JT +1608			
	C529	00D 254 4740 976	CE67W1C100MT(GV)			
	C530	nsp	CC73CH1H101JT +1608			
	C531	00D 254 4740 921	CE67W1C470MT(GV)			
	C532	nsp	CC73CH1H101JT +1608			
	C533	nsp	CK73B1H102KT +1005			

	Ref. No.	Part No.	Part Name	Remarks	Q'ty	New
	C534	nsp	CK73F1E104ZT +1608			
	C535	nsp	CC73CH1H121JT +1608			
	C536	00D 254 4740 976	CE67W1C100MT(GV)			
	C537	nsp	CC73CH1H101JT +1608			
	C538	00D 254 4740 921	CE67W1C470MT(GV)			
	C539	nsp	CC73CH1H101JT +1608			
	C541,542	nsp	CC73CH1E681JT +1608			
	C543	00D 254 4742 916	CE67W1V100MT(GV)			
	C544	nsp	CK73B1H332KT +1608			
	C545,546	nsp	CK73F1E104ZT +1608			
	C547,548	00D 254 4740 934	CE67W1C101MT(GV)			
	C550,551	nsp	CC73CH1E681JT +1608			
	C552	00D 254 4742 916	CE67W1V100MT(GV)			
	C553	nsp	CK73B1H332KT +1608			
	C554	nsp	CK73F1E104ZT +1608			
	C556,557	nsp	CC73CH1E681JT +1608			
	C558	00D 254 4742 916	CE67W1V100MT(GV)			
	C559	nsp	CK73B1H332KT +1608			
	C560	nsp	CK73F1E104ZT +1608			
	C561	nsp	CK73F1H103ZT +1608			
	C563	00D 254 4743 902	CE67W1H0R1MT(GV)			
	C564	00D 254 4740 921	CE67W1C470MT(GV)			
	C565	nsp	CK73F1E104ZT +1608			
	C566	nsp	CK73B1H102KT +1608			
	C567,568	nsp	CK73F1E104ZT +1608			
	C569	00D 256 1058 971	CF93A1H104JT (JL)			
	C570,571	nsp	CK73F1E104ZT +1608			
	C572	00D 255 1265 978	CQ93M1H223JT(B)			
	C573	nsp	CC73CH1H100DT +1608			
	C574	nsp	CC73CH1H120JT +1608			
	C575	nsp	CK73B1H102KT +1608			
	C576	nsp	CK73F1E104ZT +1608			
	C577	nsp	CK73F1H103ZT +1608			
	C578	nsp	CK73F1E104ZT +1608			
	C579	nsp	CK73F1H103ZT +1608			
	C580	nsp	CK73F1E104ZT +1608			
	C581	nsp	CC73CH1H220JT +1608			
	C583	nsp	CK73F1E104ZT +1608			
	C584	nsp	CC73CH1H220JT +1608			
	C586	00D 254 4743 902	CE67W1H0R1MT(GV)			
	C587	nsp	CK73F1H103ZT +1608			
	C588	nsp	CC73CH1H220JT +1608			
	C589-591	nsp	RM73B--0R0KT +1608			
	C592	nsp	CK73B1H102KT +1608			
	C593	nsp	CK73F1E104ZT +1608			
	C601	nsp	CK73B1H102KT +1608			
	C602	nsp	CK73F1H103ZT +1608			
	C603	nsp	CK73F1E104ZT +1608			
	C604	00D 254 4740 921	CE67W1C470MT(GV)			
	C605-613	nsp	CK73F1E104ZT +1608			
	C702,703	00D 254 4742 916	CE67W1V100MT(GV)			
	C704,705	nsp	CK73B1E473KT +1608			
	C706	00D 254 4740 934	CE67W1C101MT(GV)			
	C707	nsp	CK73F1H103ZT +1608			
	C708	00D 254 4740 921	CE67W1C470MT(GV)			
	C709	nsp	CK73F1H103ZT +1608			

	Ref. No.	Part No.	Part Name	Remarks	Q'ty	New
	C710	00D 254 4742 916	CE67W1V100MT(GV)			
	C711	nsp	CK73F1H103ZT +1608			
	C712	nsp	CK73F1E104ZT +1608			
	C714	nsp	CK73B1H222KT +1608			
	C715	nsp	CK73B1E473KT +1608			
	C716,717	nsp	CK73B1A224KT +1608			
	C718	nsp	CK73B1E473KT +1608			
	C719	nsp	CK73B1H222KT +1608			
	C720,721	nsp	CK73F1E104ZT +1608			
	C724,725	00D 254 4742 903	CE67W1V4R7MT(GV)			
	C726	00D 254 4740 921	CE67W1C470MT(GV)			
	C727,728	nsp	CK73F1H103ZT +1608			
	C729	nsp	CK73F1E104ZT +1608			
	C731	nsp	CK73F1E104ZT +1608			
	C732-739	00D 254 4742 916	CE67W1V100MT(GV)			
	C740	nsp	CK73F1E104ZT +1608			
	C741	00D 254 4740 934	CE67W1C101MT(GV)			
	C742,743	nsp	CC73CH1H101JT +1608			
	C744	nsp	CK73F1E104ZT +1608			
	C745	00D 254 4740 934	CE67W1C101MT(GV)			
	C746	nsp	CK73F1H103ZT +1608			
	C749	00D 254 4742 916	CE67W1V100MT(GV)			
	C751	nsp	CC73CH1H101JT +1608			
	C752	00D 254 4740 976	CE67W1C100MT(GV)			
	C753-755	nsp	CK73F1E104ZT +1608			
	C758	00D 254 4742 929	CE67W1V220MT(GV)			
	C759	nsp	CK73F1E104ZT +1608			
	C760	00D 254 4742 916	CE67W1V100MT(GV)			
	C762	nsp	CC73CH1H470JT +1608			
	C763	00D 254 4742 929	CE67W1V220MT(GV)			
	C764	nsp	CK73F1E104ZT +1608			
	C765	00D 254 4742 916	CE67W1V100MT(GV)			
	C767	00D 254 4742 916	CE67W1V100MT(GV)			
	C769	nsp	CC73CH1H101JT +1608			
	C770	00D 254 4740 976	CE67W1C100MT(GV)			
	C771	nsp	CK73F1H103ZT +1608			
	C774	00D 254 4742 929	CE67W1V220MT(GV)			
	C775	nsp	CK73F1E104ZT +1608			
	C777	nsp	CC73CH1H470JT +1608			
	C778	00D 254 4742 929	CE67W1V220MT(GV)			
	C779	nsp	CK73F1E104ZT +1608			
	C781	00D 254 4742 916	CE67W1V100MT(GV)			
	C783	nsp	CC73CH1H221JT +1608			
	C784	00D 254 4740 976	CE67W1C100MT(GV)			
	C785,786	nsp	CK73F1E104ZT +1608			
	C790	00D 254 4742 929	CE67W1V220MT(GV)			
	C791	nsp	CK73F1E104ZT +1608			
	C793	nsp	CC73CH1H470JT +1608			
	C794	00D 254 4742 929	CE67W1V220MT(GV)			
	C795	nsp	CK73F1E104ZT +1608			
	C796	00D 254 4742 916	CE67W1V100MT(GV)			
	C798	nsp	CC73CH1H470JT +1608			
	C799	nsp	CK73F1E104ZT +1608			
	C800	00D 254 4742 916	CE67W1V100MT(GV)			
	C802	nsp	CC73CH1H470JT +1608			
	C803	nsp	CK73F1E104ZT +1608			



	Ref. No.	Part No.	Part Name	Remarks	Q'ty	New
	C804,805	00D 254 4740 976	CE67W1C100MT(GV)			
	C806,807	nsp	CK73B1H102KT +1608			
	C808	nsp	CC73CH1H121JT +1608			
	C810	nsp	CC73CH1H121JT +1608			
	C811	nsp	CK73F1E104ZT +1608			
	C812-814	00D 254 4740 976	CE67W1C100MT(GV)			
	C815,816	nsp	CK73B1H102KT +1608			
	C817	nsp	CC73CH1H121JT +1608			
	C819	nsp	CC73CH1H121JT +1608			
	C820	nsp	CK73F1E104ZT +1608			
	C821	00D 254 4740 976	CE67W1C100MT(GV)			
	C841-846	nsp	CC73CH1H221JT +1608			
	CC901	nsp	CK73F1E104ZT +1608			
	CC902	nsp	CK73F1H103ZT +1608			
	CC903	nsp	CK73B1H102KT +1608			
	CC904	nsp	CK73F1E104ZT +1608			
	CC905	nsp	CK73F1H103ZT +1608			
	CC906	nsp	CK73B1H102KT +1608			
	CC907	nsp	CK73F1E104ZT +1608			
	CC908	nsp	CK73F1H103ZT +1608			
	CC909	nsp	CK73B1H102KT +1608			
	CC910	nsp	CK73F1E104ZT +1608			
	CC911	nsp	CK73F1H103ZT +1608			
	CC912	nsp	CK73B1H102KT +1608			
	CC913	nsp	CK73F1E104ZT +1608			
	CC914	nsp	CK73F1H103ZT +1608			
	CC915	nsp	CK73B1H102KT +1608			
	CC916	nsp	CK73F1E104ZT +1608			
	CC917	nsp	CK73F1H103ZT +1608			
	CC918	nsp	CK73B1H102KT +1608			
	CC919	nsp	CK73F1E104ZT +1608			
	CC920	nsp	CK73F1H103ZT +1608			
	CC921	nsp	CK73B1H102KT +1608			
	CC922	nsp	CK73F1E104ZT +1608			
	CC923	nsp	CK73F1H103ZT +1608			
	CC924	nsp	CK73B1H102KT +1608			
	CC925	nsp	CK73F1E104ZT +1608			
	CC926	nsp	CK73F1H103ZT +1608			
	CC927	nsp	CK73B1H102KT +1608			
	CC928	nsp	CK73F1E104ZT +1608			
	CC929	nsp	CK73F1H103ZT +1608			
	CC930	nsp	CK73B1H102KT +1608			
	CC931	nsp	CK73F1E104ZT +1608			
	CC932	nsp	CK73F1H103ZT +1608			
	CC933	nsp	CK73B1H102KT +1608			
	CC934	nsp	CK73F1E104ZT +1608			
	CC935	nsp	CK73F1H103ZT +1608			
	CC936	nsp	CK73B1H102KT +1608			
	CC939	nsp	CK73F1E104ZT +1608			
	CC940	nsp	CK73F1H103ZT +1608			
	CC941	nsp	CK73B1H102KT +1608			
	CC942-944	nsp	CK73F1E104ZT +1608			
	CC945	nsp	CK73B1H103KT (1608) +1608			
	CC946	nsp	CK73F1H103ZT +1608			
	CC947	nsp	CK73B1H102KT +1608			

	Ref. No.	Part No.	Part Name	Remarks	Q'ty	New
<b>OTHERS PARTS GROUP</b>						
	CX031	nsp	3P PH CON.BASE(TAPE) +REF			
	CX033	nsp	3P ZH-ZR CON.BASE-T			
	CX051	nsp	5P CONN.BASE(KR-PH)			
	CX052	nsp	5P ZH-ZR CON.BASE-T			
	CX061	nsp	6P PH CON.BASE +REF			
	CX091	nsp	9P CON.BASE TUC-P			
	CX121	nsp	12P CON.BASE TUC-P			
	CX123,124	nsp	12P PIN HEADER(9120)			
	CX153	nsp	15P CON.BASE TUC-P			
	CX171	00D 205 1343 989	17P FFC BASE(9610SC)			
	CX211	00D 205 1343 947	21P FFC BASE(9610SC)			
	CX301	00D 205 1401 902	30P-FFC-BASE(9610SC)			
	CX501	00D 205 1428 901	50P SOCKET (377)			
	CX501	00D 205 1429 007	50P PLUG (377)			
	CX801	00D 205 1430 902	80P SOCKET (377)			
	CX801	00D 205 1431 008	80P PLUG (377)			
	FB101	nsp	FBMJ1608HS280NT +1608			
	FB204,205	nsp	CHIP EMIFIL(11A121) +1608			
	FB501	nsp	CHIP EMIFIL(11A121) +1608			
	JK181	00D 205 1369 905	I-POD_CONNECTOR			
	JK301	00D 204 8713 001	2P/S-TERM(SYK22)			
	JK501	00D 204 8593 001	1P PIN JACK(OR,NI)			*
	JK601	00D 204 8749 004	6P PIN JACK(FGND NI)			
	L201	00D 235 0166 003	INDUCTOR 100UH(7208M)			
	L301	00D 235 0186 902	INDUCTOR 47UH(7B12N)			
	L302	00D 235 0185 903	INDUCTOR 47UH(7E10H)			
	L303	00D 235 0186 902	INDUCTOR 47UH(7B12N)			
	L401	00D 235 0183 905	INDUCTOR 2.2UH(7E06N)			
	L503	00D 235 0060 905	INDUCTOR(2R2)ST			
	S201	00D 279 0051 008	NTSA0WB203EE1B0			
	ST101-103	nsp	STYLE PIN			
	ST105,106	nsp	STYLE PIN			
△	T201	00D 231 8087 001	D/D TRANS(060478026)			*
	W801	nsp	M3 SCREW TERMINAL			
	X101	00D 399 0619 906	XTAL(27MHZ) +REF			
	X201	00D 399 1090 906	CSTCW24M0X51R-R0			
	X301	00D 399 1104 902	CSTCE12M0G52-R0			*
	X401	00D 399 1113 906	X-TAL(L5030-16.660)			*
	X501	00D 399 1116 903	X-TAL(S-24.576)			*

## 1U-3809A VIDEO P.W.B. UNIT ASS'Y

Ref. No.	Part No.	Part Name	Remarks	Q'ty	New
<b>SEMICONDUCTORS GROUP</b>					
IC101	00D 262 3495 003	ADV7403BSTZ-110			*
IC104,105	00D 263 1295 907	TA48018BF(T6L1,NQ)			*
IC106	00D 263 1297 905	TA48033BF(T6L1,NQ)			*
IC110	00D 263 1278 908	SI-8001FDE			
IC201	nsp	EP2C35F484C8N			
IC202	00D 262 3718 007	NT5DS16M16CS-6K			
IC203	00D 262 3715 929	M25P64-VMF6TG(EE5B)			
IC204	00D 262 3767 906	EPCS16S116N/PT(GUI)			*
IC205	00D 262 3714 904	FCXO-05(48.0MHZ)			*
IC206	00D 262 3473 902	LP2995M			
IC207	00D 263 1296 906	TA48025BF(T6L1,NQ)			
IC208	00D 263 1272 904	LM2832XMY			
IC209	00D 262 3754 906	CDCVF2505PWR			
IC301	nsp	FLI2310-LF-CF			
IC302	00D 262 3598 007	K4S643232H-UC60			
IC401	00D 262 3364 011	SII9030CTU-7			
IC501,502	00D 262 3478 004	ADV7320			
IC505	00D 262 3277 904	SN74LVC157APW-EL2 +C			
IC507	00D 262 2977 917	BA25BC0FP-E2			
IC509	00D 262 2977 917	BA25BC0FP-E2			
IC510	00D 263 1296 906	TA48025BF(T6L1,NQ)			*
IC511	00D 263 1282 907	BD7820FP-E2			*
IC601	00D 262 3551 002	NJW1321FP1			
IC602	00D 263 1225 906	NJM2581M-TE1			
IC604	00D 263 1295 907	TA48018BF(T6L1,NQ)			
IC701,702	00D 262 3445 901	TC4051BFT			
IC703	00D 262 3446 900	TC4052BFT			
IC704	00D 262 3445 901	TC4051BFT			
IC706	00D 263 1082 903	TK15420MTL +C			
IC707	00D 263 1273 903	NJM2566AV			
IC708	00D 263 1082 903	TK15420MTL +C			
TR101	00D 269 0192 902	KRC102S-RTK/P (10K-10K)			
TR401	00D 275 0110 905	HN1K02FU-TE85L			
TR501-505	00D 271 0293 901	2SA1022-B +C			
TR601	00D 275 0110 905	HN1K02FU-TE85L			
TR602	00D 271 0312 905	KTA1504S-GR-RTK/P			
TR603	00D 269 0144 905	DTC114YKA-T146 +C			
TR604	00D 269 0192 902	KRC102S-RTK/P (10K-10K)			
TR701,702	00D 269 0192 902	KRC102S-RTK/P (10K-10K)			
TR703	00D 271 0312 905	KTA1504S-GR-RTK/P			
TR704,705	00D 269 0192 902	KRC102S-RTK/P (10K-10K)			
TR706	00D 271 0312 905	KTA1504S-GR-RTK/P			
D101	00D 276 0794 900	KDS160-RTK/P			
D103,104	00D 276 0794 900	KDS160-RTK/P			
D105	00D 276 0827 903	SPB-G54SVR			
D201	00D 276 0794 900	KDS160-RTK/P			
D304	00D 276 0846 900	RB060M-30			
D401-408	00D 276 0833 900	ESD PROTECTOR(6802)			
D501	00D 276 0794 900	KDS160-RTK/P			
D503	00D 276 0794 900	KDS160-RTK/P			
D511,512	00D 276 0794 900	KDS160-RTK/P			
D604	00D 276 0773 905	RB501V-40 +2125			

	Ref. No.	Part No.	Part Name	Remarks	Q'ty	New
	D608-610	00D 276 0794 900	KDS160-RTK/P			
	D713,714	00D 276 0794 900	KDS160-RTK/P			
	D721,722	00D 276 0794 900	KDS160-RTK/P			
	ZD801	00D 276 0683 930	UDZS5.1B-TE17 +C			
<b>RESISTORS GROUP</b>						
	R241	nsp	CK73F1E104ZT +1608			
	R242	nsp	CK73B1H102KT +1608			
	R243	nsp	CK73F1E104ZT +1608			
	R244	nsp	CK73B1H102KT +1608			
	R245	nsp	CK73F1E104ZT +1608			
	R246	nsp	CK73B1H102KT +1608			
	R247	nsp	CK73F1E104ZT +1608			
	R248	nsp	CK73B1H102KT +1608			
	VR501-505	00D 211 6148 906	V03PB471MT(RH03ADCS) +REF			
<b>CAPACITORS GROUP</b>						
	C101-103	nsp	CK73F1C104ZT +1005			
	C104	00D 257 2018 900	CS77B1A100MT(NOJ)			
	C105,106	nsp	CC73CH1H6R0DT +1608			
	C107	00D 257 3023 949	CF73=1C103JT(ECHUX)			
	C108	00D 257 3024 951	CF73=1C823JT(ECHUX)			
	C109	nsp	CK73F1C104ZT +1005			
	C110	nsp	CK73B1H102KT +1005			
	C111	nsp	CK73F1C104ZT +1005			
	C114,115	nsp	CK73F1C104ZT +1005			
	C116	nsp	CK73F1H103ZT +1005			
	C117,118	nsp	CK73F1C104ZT +1005			
	C119-121	00D 257 2018 900	CS77B1A100MT(NOJ)			
	C122,123	nsp	CK73F1C104ZT +1005			
	C124	00D 257 2018 900	CS77B1A100MT(NOJ)			
	C125	nsp	CK73F1C104ZT +1005			
	C126	nsp	CK73F1H103ZT +1005			
	C127,128	nsp	CK73B1H102KT +1005			
	C129	00D 257 2018 900	CS77B1A100MT(NOJ)			
	C130	nsp	CC73CH1H100DT +1005			
	C131,132	nsp	CK73B1H102KT +1005			
	C134,135	nsp	CK73B1H102KT +1005			
	C136	00D 257 2018 900	CS77B1A100MT(NOJ)			
	C138,139	nsp	CK73B1H102KT +1005			
	C140	00D 257 2018 900	CS77B1A100MT(NOJ)			
	C146	nsp	CK73B1E104KT +1608			
	C152	nsp	CK73B1E104KT +1608			
	C154	nsp	CK73B1E104KT +1608			
	C156	nsp	CK73B1E104KT +1608			
	C157	nsp	CK73B1H102KT +1005			
	C159	nsp	CK73B1E104KT +1608			
	C161	nsp	CK73B1E104KT +1608			
	C171	nsp	CK73F1H103ZT +1005			
	C172	nsp	CK73F1C104ZT +1005			
	C201	nsp	CK73F1E104ZT +1608			
	C202	nsp	CK73F1H103ZT +1608			

	Ref. No.	Part No.	Part Name	Remarks	Q'ty	New
	C203	00D 254 4740 934	CE67W1C101MT(GV)			
	C204	nsp	CK73F1E104ZT +1608			
	C205	nsp	CK73F1H103ZT +1608			
	C206	00D 254 4740 934	CE67W1C101MT(GV)			
	C214	nsp	CK73F1E104ZT +1608			
	C215	nsp	CK73F1H103ZT +1608			
	C216-220	nsp	CK73F1E104ZT +1608			
	C221	nsp	CK73F1C104ZT +1005			
	C222	nsp	CK73F1H103ZT +1005			
	C223	nsp	CK73B1H102KT +1005			
	C224	nsp	CK73F1C104ZT +1005			
	C225	nsp	CK73F1H103ZT +1005			
	C226	nsp	CK73B1H102KT +1005			
	C227	nsp	CK73F1C104ZT +1005			
	C228	nsp	CK73F1H103ZT +1005			
	C229	nsp	CK73B1H102KT +1005			
	C230	nsp	CK73F1C104ZT +1005			
	C231	nsp	CK73F1H103ZT +1005			
	C232	nsp	CK73B1H102KT +1005			
	C233	nsp	CK73F1C104ZT +1005			
	C234	nsp	CK73F1H103ZT +1005			
	C235	nsp	CK73B1H102KT +1005			
	C238	nsp	CK73B1H102KT +1005			
	C239	nsp	CK73F1C104ZT +1005			
	C240	nsp	CK73F1H103ZT +1005			
	C241	nsp	CK73B1H102KT +1005			
	C242	nsp	CK73F1C104ZT +1005			
	C243	nsp	CK73F1H103ZT +1005			
	C244	nsp	CK73B1H102KT +1005			
	C245	nsp	CK73F1C104ZT +1005			
	C246	nsp	CK73F1H103ZT +1005			
	C247	nsp	CK73B1H102KT +1005			
	C248	nsp	CK73F1C104ZT +1005			
	C249	nsp	CK73F1H103ZT +1005			
	C250	nsp	CK73B1H102KT +1005			
	C251	nsp	CK73F1C104ZT +1005			
	C252	nsp	CK73F1H103ZT +1005			
	C253	nsp	CK73B1H102KT +1005			
	C254	nsp	CK73F1C104ZT +1005			
	C255	nsp	CK73F1H103ZT +1005			
	C256	nsp	CK73B1H102KT +1005			
	C291	00D 254 4709 700	CE04W1V221MC JC5(KY)			
	C292	00D 257 1020 915	CK73B1H225KT			
	C293	nsp	CK73B1E104KT +1608			
	C295	nsp	CK73F1E104ZT +1608			
	C296	00D 254 4711 905	CE04W1A471MT HB5(KY)			
	C301-305	nsp	CK73F1C104ZT +1005			
	C306	00D 257 2018 900	CS77B1A100MT(NOJ)			
	C307	nsp	CK73F1C104ZT +1005			
	C308	00D 257 2018 900	CS77B1A100MT(NOJ)			
	C309	nsp	CK73F1C104ZT +1005			
	C310	nsp	CK73B1H102KT +1005			
	C311	nsp	CK73F1H103ZT +1005			
	C312	nsp	CC73CH1H101JT +1005			
	C313	00D 257 2018 900	CS77B1A100MT(NOJ)			
	C314-323	nsp	CK73F1C104ZT +1005			

	Ref. No.	Part No.	Part Name	Remarks	Q'ty	New
	C324	nsp	CK73B1H102KT +1005			
	C325	nsp	CK73F1C104ZT +1005			
	C326	nsp	CK73B1H102KT +1005			
	C327,328	nsp	CK73F1C104ZT +1005			
	C329	nsp	CK73B1H102KT +1005			
	C330	00D 257 2018 900	CS77B1A100MT(NOJ)			
	C331	nsp	CK73F1C104ZT +1005			
	C332	nsp	CK73B1H102KT +1005			
	C333-342	nsp	CK73F1C104ZT +1005			
	C344	nsp	CK73F1C104ZT +1005			
	C345-349	nsp	CK73B1H102KT +1005			
	C350-353	nsp	CK73F1C104ZT +1005			
	C355	nsp	CK73F1C104ZT +1005			
	C356	00D 257 2018 900	CS77B1A100MT(NOJ)			
	C357,358	00D 257 0039 910	CK73B0J226MT			
	C359	nsp	CK73F1C104ZT +1005			
	C364,365	nsp	CK73B1H102KT +1005			
	C366	00D 257 2018 900	CS77B1A100MT(NOJ)			
	C367-369	00D 257 0039 910	CK73B0J226MT			
	C370	nsp	CK73B1H102KT +1005			
	C372	nsp	CK73B1H102KT +1005			
	C373	00D 257 2018 900	CS77B1A100MT(NOJ)			
	C374	00D 254 4570 939	CE67C1C221MT(MVY) +REF			
	C381-390	nsp	CK73B1H102KT +1005			
	C391-400	nsp	CK73F1C104ZT +1005			
	C401	00D 257 2018 900	CS77B1A100MT(NOJ)			
	C402-411	nsp	CK73B1H102KT +1005			
	C412-421	nsp	CK73F1C104ZT +1005			
	C422	00D 257 2018 900	CS77B1A100MT(NOJ)			
	C423-432	nsp	CK73B1H102KT +1005			
	C433-442	nsp	CK73F1C104ZT +1005			
	C443	00D 257 2018 900	CS77B1A100MT(NOJ)			
	C444	nsp	CK73B1H102KT +1005			
	C445	nsp	CK73F1C104ZT +1005			
	C446	00D 257 2018 900	CS77B1A100MT(NOJ)			
	C447,448	nsp	CK73B1H102KT +1005			
	C449,450	nsp	CK73F1C104ZT +1005			
	C451,452	00D 257 2018 900	CS77B1A100MT(NOJ)			
	C453	nsp	CK73B1H102KT +1005			
	C454	nsp	CK73F1C104ZT +1005			
	C455	00D 257 2018 900	CS77B1A100MT(NOJ)			
	C456	nsp	CK73B1H102KT +1005			
	C457	nsp	CK73F1C104ZT +1005			
	C458	00D 257 2018 900	CS77B1A100MT(NOJ)			
	C459,460	nsp	CK73B1H102KT +1005			
	C461,462	nsp	CK73F1C104ZT +1005			
	C463,464	00D 257 2018 900	CS77B1A100MT(NOJ)			
	C465	nsp	CK73B1H102KT +1005			
	C466	nsp	CK73F1C104ZT +1005			
	C467	00D 257 2018 900	CS77B1A100MT(NOJ)			
	C471	00D 257 2018 900	CS77B1A100MT(NOJ)			
	C472	nsp	CK73F1C104ZT +1005			
	C473	nsp	CK73F1H103ZT +1005			
	C474	nsp	CK73B1H102KT +1005			
	C475	nsp	CC73CH1H101JT +1005			
	C476	nsp	CC73CH1H200JT +1005			

	Ref. No.	Part No.	Part Name	Remarks	Q'ty	New
	C477,478 C479	00D 257 5003 983 00D 257 2018 900	CC73CH1H470JT CS77B1A100MT(NOJ)			
	C481,482 C486,487 C501 C502,503 C504	nsp nsp nsp nsp nsp	CC73CH1H101JT +1005 CC73CH1H100DT +1005 CK73F1H103ZT +1005 CK73F1C104ZT +1005 CK73F1H103ZT +1005			
	C505-508 C509 C510 C511 C512	nsp nsp 00D 257 2018 900 nsp nsp	CK73F1C104ZT +1005 CK73F1H103ZT +1005 CS77B1A100MT(NOJ) CK73F1H103ZT +1005 CK73F1C104ZT +1005			
	C513 C514-523 C524,525 C526-531 C532	00D 257 2018 900 nsp nsp nsp nsp	CS77B1A100MT(NOJ) CK73F1C104ZT +1005 CC73CH1H180JT +1608 CK73F1C104ZT +1005 CK73F1H103ZT +1005			
	C533 C534 C535 C536 C537-548	nsp nsp nsp 00D 257 2018 900 nsp	CK73B1H102KT +1005 CK73F1H103ZT +1005 CK73F1C104ZT +1005 CS77B1A100MT(NOJ) CK73F1C104ZT +1005			
	C549,550 C551 C552 C553 C554	nsp nsp nsp nsp nsp	CK73B1H102KT +1005 CK73F1C104ZT +1005 CK73B1E104KT +1608 CK73F1C104ZT +1005 CK73F1H103ZT +1608			
	C555 C556 C557 C559 C601-604	nsp 00D 257 2018 900 nsp 00D 257 2018 900 nsp	CK73F1C104ZT +1005 CS77B1A100MT(NOJ) CK73F1C104ZT +1005 CS77B1A100MT(NOJ) CK73F1C104ZT +1005			
	C607 C608,609 C610 C611 C612	00D 257 2018 900 nsp 00D 257 2018 900 nsp 00D 257 2018 900	CS77B1A100MT(NOJ) CK73B1H102KT +1005 CS77B1A100MT(NOJ) CK73B1H102KT +1005 CS77B1A100MT(NOJ)			
	C613 C614 C615,616 C617 C618	nsp 00D 257 2018 900 nsp nsp nsp	CK73F1C104ZT +1005 CS77B1A100MT(NOJ) CK73B1H102KT +1005 CK73F1C104ZT +1005 CK73B1H102KT +1005			
	C620,621 C622,623 C624 C625,626 C627	00D 257 5003 983 nsp nsp nsp nsp	CC73CH1H470JT CK73F1C104ZT +1005 CK73B1H102KT +1005 CK73F1C104ZT +1005 CK73B1H102KT +1005			
	C628 C629,630 C635 C636 C637-640	00D 257 2018 900 nsp nsp 00D 257 2018 900 nsp	CS77B1A100MT(NOJ) CK73B1E104KT +1608 CK73B1H102KT +1005 CS77B1A100MT(NOJ) CK73B1E104KT +1608			
	C641 C642 C643 C644	nsp nsp nsp nsp	CK73F1C104ZT +1005 CK73F1H103ZT +1005 CK73F1E104ZT +1608 CK73F1H103ZT +1608			

Ref. No.	Part No.	Part Name	Remarks	Q'ty	New
C645	nsp	CK73B1H102KT +1608			
C701,702	00D 257 2018 900	CS77B1A100MT(NOJ)			
C703-705	nsp	CK73F1C104ZT +1005			
C708	nsp	CK73F1H103ZT +1005			
C711	nsp	CK73F1E104ZT +1608			
C713	00D 257 2018 900	CS77B1A100MT(NOJ)			
C714,715	nsp	CK73F1C104ZT +1005			
C716	nsp	CK73F1E104ZT +1608			
C717	nsp	CK73B1H821KT +1608			
C718	nsp	CK73B1H392KT +1608			
C719	nsp	CK73B1H102KT +1005			
C720-722	nsp	CK73F1E104ZT +1608			
C723	00D 257 2018 900	CS77B1A100MT(NOJ)			
C725	nsp	CK73F1C104ZT +1005			
C727	00D 257 2018 900	CS77B1A100MT(NOJ)			
C728	00D 254 4740 918	CE67W1C330MT(GV)			
C729	nsp	CK73F1E104ZT +1608			
C735	00D 257 2018 900	CS77B1A100MT(NOJ)			
C736	nsp	CK73F1C104ZT +1005			
C737	00D 257 2018 900	CS77B1A100MT(NOJ)			
C738,739	nsp	CK73F1C104ZT +1005			
C742	nsp	CK73F1H103ZT +1005			
C745	nsp	CK73F1E104ZT +1608			
C747	00D 257 2018 900	CS77B1A100MT(NOJ)			
C748,749	nsp	CK73F1C104ZT +1005			
C750	nsp	CK73F1E104ZT +1608			
C751	nsp	CK73B1H821KT +1608			
C752	nsp	CK73B1H392KT +1608			
C753,754	nsp	CK73F1E104ZT +1608			
C755	nsp	CK73B1H102KT +1005			
C756	nsp	CK73F1C104ZT +1005			
C770	nsp	CK73F1C104ZT +1005			
C773	nsp	CK73F1C104ZT +1005			
C775,776	nsp	CK73B1H102KT +1005			
C778,779	nsp	CK73B1H102KT +1005			
C801-803	nsp	CC73CH1H470JT +1608			
C804,805	nsp	CK73B1E104KT +1608			
C806,807	00D 254 4740 976	CE67W1C100MT(GV)			
C808	nsp	CK73B1E104KT +1608			
C809	00D 254 4740 976	CE67W1C100MT(GV)			
C810-812	nsp	CK73F1E104ZT +1608			
C813	00D 254 4740 934	CE67W1C101MT(GV)			
C814	nsp	CK73F1E104ZT +1608			
C815	00D 254 4743 944	CE67W1H010MT(GV)			
C816-818	nsp	CK73F1E104ZT +1608			
C819,820	00D 254 4740 976	CE67W1C100MT(GV)			
C821,822	nsp	CK73F1E104ZT +1608			
C823,824	00D 254 4740 934	CE67W1C101MT(GV)			
C825,826	nsp	CK73B1H103KT (1608) +1608			
C827	00D 254 4740 934	CE67W1C101MT(GV)			
C828	nsp	CK73B1H103KT (1608) +1608			
C829	00D 254 4740 934	CE67W1C101MT(GV)			
C830-833	nsp	CK73F1H103ZT +1608			
C834	00D 254 4740 934	CE67W1C101MT(GV)			
C835,836	nsp	CK73F1H103ZT +1608			
C837-839	nsp	CC73CH1H470JT +1608			



	Ref. No.	Part No.	Part Name	Remarks	Q'ty	New
	C840-842	00D 254 4740 934	CE67W1C101MT(GV)			
	C843-845	nsp	CK73B1H103KT (1608) +1608			
	C846	00D 254 4740 976	CE67W1C100MT(GV)			
	C854	nsp	CK73B1E473KT +1608			
	C855	nsp	CC73CH1H221JT +1608			
	C856	nsp	CK73B1H103KT (1608) +1608			
	C857	nsp	CK73B1E473KT +1608			
	C858	00D 254 4743 944	CE67W1H010MT(GV)			
	C859	nsp	CK73B1E473KT +1608			
	C911,912	nsp	CK73F1E104ZT +1608			
	C915,916	nsp	CK73F1E104ZT +1608			
	C918	00D 254 4740 934	CE67W1C101MT(GV)			
	C920	nsp	CK73F1E104ZT +1608			
	C922	nsp	CK73F1E104ZT +1608			
	C923	00D 254 4740 934	CE67W1C101MT(GV)			
	C925,926	nsp	CK73F1E104ZT +1608			
	C928	00D 254 4740 934	CE67W1C101MT(GV)			
	C930	00D 254 4740 934	CE67W1C101MT(GV)			
	C935	nsp	CK73B1E473KT +1608			
	C936	00D 254 4743 944	CE67W1H010MT(GV)			
	C937	nsp	CK73B1E104KT +1608			
	C938,939	nsp	CK73B1E473KT +1608			
	C955,956	nsp	CK73F1E104ZT +1608			
	C958	00D 254 4740 934	CE67W1C101MT(GV)			
	C963	00D 254 4740 934	CE67W1C101MT(GV)			
	C964	nsp	CK73F1E104ZT +1608			
	C965	00D 254 4740 934	CE67W1C101MT(GV)			
	C966	nsp	CK73F1E104ZT +1608			
	C968	nsp	CK73B1E473KT +1608			
	C969	00D 254 4743 944	CE67W1H010MT(GV)			
	C970	nsp	CK73B1E104KT +1608			
	C971,972	nsp	CK73B1E473KT +1608			
	C974	nsp	CK73B1E104KT +1608			
	C975-979	00D 254 4740 976	CE67W1C100MT(GV)			
	C980	nsp	CK73F1E104ZT +1608			
	C981	nsp	CK73F1H103ZT +1608			
	C982	00D 254 4740 934	CE67W1C101MT(GV)			
	C983	nsp	CK73B1E104KT +1608			
	C984	00D 254 4740 934	CE67W1C101MT(GV)			
	C985-989	00D 254 4738 946	CE67W0J102MT(GV)			
	C990-993	nsp	CK73B1E104KT +1608			
<b>OTHERS PARTS GROUP</b>						
	CN071	nsp	7P FFC BASE(9610SC)			
	CX122	nsp	12P CON.BASE TUC-P			
	CX401	nsp	40P CON.SOCKET 9828S			
	CY033	nsp	3P ZH-ZR CON.BASE-T			
	CY072	nsp	7P ZH-ZR CON.BASE-T			
	CY501	00D 205 1428 901	50P SOCKET (377)			
	CY801	00D 205 1430 902	80P SOCKET (377)			
	FB101	nsp	FBMJ1608HS280NT +1608			
	FB201-214	nsp	FBMJ1608HS280NT +1608			

Ref. No.	Part No.	Part Name	Remarks	Q'ty	New
FB301,302 FB501 FB614	nsp nsp nsp	FBMJ1608HS280NT +1608 FBMJ1608HS280NT +1608 FBMJ1608HS280NT +1608			
JK104 JK401 JK701  L105	00D 204 8733 007 00D 204 8719 005 00D 204 8711 003  00D 235 0187 901	6P PIN JACK(FG GBR) 19P HDMI CONNECTOR 1P/S-TERM(SYK22)  INDUCTOR 22UH(7B12H)			
L201 L202 L401-403 L504 L701	00D 235 0125 905 00D 235 0183 905 00D 235 0125 905 00D 235 0125 905 00D 235 0125 905	INDUCTOR(FLC32C220K)+3216 INDUCTOR 2.2UH(7E06N) INDUCTOR(FLC32C220K)+3216 INDUCTOR(FLC32C220K)+3216 INDUCTOR(FLC32C220K)+3216			
W401  X101 X301	nsp  00D 399 1000 909 00D 399 0864 900	M3 SCREW TERMINAL  FCX-03(28.63636MHZ) XTAL(13.5MHZ) +REF			

## 1U-3810A/B L.PWR/DISP P.W.B. UNIT ASS'Y

Ref. No.	Part No.	Part Name	Remarks	Q'ty	New
<b>SEMICONDUCTORS GROUP</b>					
IC101	00D 263 1100 063	KIA7809API-U/P			
IC102	00D 263 1259 008	BA12T			
IC103	00D 263 1260 000	KIA79M12PI-U/P			
IC104	00D 263 1227 001	BA50BC0T			
IC105	00D 263 1268 002	KIA79M05PI-U/P			
IC106	00D 263 1269 904	BA178M18CP-E2			
IC107	00D 265 0130 001	STR-G7421(LF1129)			
IC108	00D 263 1155 005	SE-B2(LF12)			
IC201	00D 262 3228 005	M66005-0001AHP			
IC202	00D 262 2745 903	BU2090F(E2) +C			
IC203	00D 263 1236 908	BA00BCOWFP			
IC204	00D 262 3602 003	GP1UE271XKVF			
IC205	00D 262 3511 000	S9648			
IC701	00D 262 3571 901	HIN202EIBNZ-T			
IC801	00D 262 2580 906	CXA1511M +C			
IC802	00D 262 3360 905	LC72722PM-TLM	for E2		
TR101	00D 269 0184 907	KRA102S-RTK/P (10K-10K)			
TR102	00D 269 0192 902	KRC102S-RTK/P (10K-10K)			
TR103	00D 273 0464 901	KTC3875S-GR-RTK/P			
TR201-203	00D 269 0192 902	KRC102S-RTK/P (10K-10K)			
TR206-214	00D 269 0184 907	KRA102S-RTK/P (10K-10K)			
TR301,302	00D 269 0192 902	KRC102S-RTK/P (10K-10K)			
TR801,802	00D 273 0486 905	KRC231S-RTK(2.2K)			
TR803	00D 269 0192 902	KRC102S-RTK/P (10K-10K)			
TR804	00D 269 0184 907	KRA102S-RTK/P (10K-10K)			
TR805	00D 271 0331 902	2SA2092QTL			
TR806	00D 269 0192 902	KRC102S-RTK/P (10K-10K)			
TR807	00D 269 0184 907	KRA102S-RTK/P (10K-10K)			
TR808	00D 269 0192 902	KRC102S-RTK/P (10K-10K)			
TR809	00D 273 0464 901	KTC3875S-GR-RTK/P	for E2		
D101	00D 276 0794 900	KDS160-RTK/P			
D103	00D 276 0724 912	SARS01T (V0)			
D104-108	00D 276 0780 901	SFPX-62 +C			
D109-112	00D 276 0773 905	RB501V-40 +2125			
D113-116	00D 276 0794 900	KDS160-RTK/P			
D751,752	00D 276 0794 900	KDS160-RTK/P			
D801,802	00D 276 0794 900	KDS160-RTK/P			
ZD101	00D 276 0848 908	UDZS22B-TE17			
ZD201	ZD2 01				
ZD801	00D 276 0683 901	UDZS5.6B-TE17 +C			
ZD951	00D 276 0837 906	NSAD500F-T1B-A			
LD101	00D 262 3047 008	PC123Y22			
LD201,202	00D 393 9668 002	SLR343BCT3F			
LD203	00D 393 9654 003	SLI343YY3F (YEL)			
LD204	00D 393 9655 002	SLI343UR3F (RED)			
LD205-209	00D 393 9668 002	SLR343BCT3F			
LD301	00D 393 9668 002	SLR343BCT3F			
FL201	00D 393 8084 001	VFD (15-BT-102GN)			

Ref. No.	Part No.	Part Name	Remarks	Q'ty	New
<b>RESISTORS GROUP</b>					
R113,114	00D 244 2671 927	RS14B3D0R1JNBST(S)			
R115	00D 244 2043 953	RS14B3A471JNBST(S)			
R116	00D 244 2051 987	RS14B3A4R7JNBST(S)			
<b>CAPACITORS GROUP</b>					
C101-104	nsp	CK73F1H103ZT +1608			
C107-114	nsp	CK73F1H103ZT +1608			
C115	nsp	RM73B--0R0KT +1608			
C119-121	nsp	RM73B--0R0KT +1608			
C122-124	nsp	CK73F1H103ZT +1608			
C125	nsp	CK73F1E104ZT +1608			
C126	nsp	CK73F1H103ZT +1608			
C127	nsp	CK73B1H102KT +1608			
C128	00D 253 1210 901	CK45B1H104KT(RPER)			
C129	nsp	CK73F1H103ZT +1608			
C130	nsp	CK73B1H102KT +1608			
C131	00D 254 4709 700	CE04W1V221MC JC5(KY)			
C132	00D 253 1210 901	CK45B1H104KT(RPER)			
C133	nsp	CK73F1H103ZT +1608			
C134	nsp	CK73B1H102KT +1608			
C135	nsp	CK73F1E104ZT +1608			
C136	nsp	CK73F1H103ZT +1608			
C137	nsp	CK73B1H102KT +1608			
C138	00D 254 4709 700	CE04W1V221MC JC5(KY)			
C140	nsp	CK73F1E104ZT +1608			
C141	00D 254 4721 911	CE04W1V100MT(GR)			
C142	nsp	CK73F1E104ZT +1608			
C143	nsp	CC73CH1H471JT +1608			
C145	nsp	CK73F1H223ZT +1608			
C146	00D 253 8033 709	CK45B3D470KC(DEA)			
C147	00D 254 4713 903	CE04W1E331MT JC5(KY)			
C148,149	nsp	CK73F1E104ZT +1608			
C150	00D 254 4718 940	CE04W1C101MT(GR)			
C151	00D 255 4261 704	CQ93P2J222KC(ECQP)			
C152	00D 254 4807 709	CE04W1E102MC K20(KY)			*
C153	00D 254 4713 903	CE04W1E331MT JC5(KY)			
C154,155	nsp	CK73F1E104ZT +1608			
C156	00D 254 4718 940	CE04W1C101MT(GR)			
C157	nsp	CK73B1H102KT +1608			
C158,159	nsp	CK73F1E104ZT +1608			
C160	00D 254 4718 940	CE04W1C101MT(GR)			
C161	00D 254 4806 700	CE04W1C222MC K25(KY)			*
C162,163	nsp	CK73F1E104ZT +1608			
C164	00D 254 4718 940	CE04W1C101MT(GR)			
C165	00D 254 4711 918	CE04W1A221MT F11(KY)			
C166	00D 254 4713 903	CE04W1E331MT JC5(KY)			
C167,168	nsp	CK73F1E104ZT +1608			
C169	00D 254 4718 940	CE04W1C101MT(GR)			
C170	00D 254 4711 918	CE04W1A221MT F11(KY)			
C171	nsp	CK73F1E104ZT +1608			
C172	nsp	CK73F1H103ZT +1608			
C175	nsp	CK73F1E104ZT +1608			
C176	nsp	CK73F1H103ZT +1608			
C177,178	nsp	CK73F1E104ZT +1608			
C179,180	nsp	CK73F1H103ZT +1608			
C181	nsp	CK73B1H102KT +1608			

	Ref. No.	Part No.	Part Name	Remarks	Q'ty	New
	C182,183	nsp	CK73F1E104ZT +1608			
	C184	nsp	CK73F1H103ZT +1608			
	C185	nsp	CK73F1E104ZT +1608			
	C186	nsp	CK73F1H103ZT +1608			
	C189	nsp	CK73F1E104ZT +1608			
	C190	nsp	CK73F1H103ZT +1608			
	C191	nsp	CK73F1E104ZT +1608			
	C192	nsp	CK73F1H103ZT +1608			
	C193	nsp	CK73B1H102KT +1608			
	C194	nsp	CK73F1E104ZT +1608			
	C195	nsp	CK73F1H103ZT +1608			
	C196	nsp	CK73B1H102KT +1608			
	C197	nsp	CK73F1E104ZT +1608			
	C198	nsp	CK73F1H103ZT +1608			
	C199	nsp	CK73B1H102KT +1608			
	C200	nsp	CK73F1E104ZT +1608			
	C201	nsp	CK73F1H103ZT +1608			
	C202	nsp	CK73B1H102KT +1608			
	C203-205	nsp	CK73F1H103ZT +1608			
	C206	nsp	CK73B1H102KT +1608			
	C207	nsp	CK73F1H103ZT +1608			
	C208	nsp	CK73F1E104ZT +1608			
	C209	00D 254 4722 981	CE04W1H100MT(GR)			
	C210	nsp	CK73B1E104KT +1608			
	C211	nsp	CK73F1H223ZT +1608			
	C301	nsp	CK73F1E104ZT +1608			
	C302	nsp	CK73B1H102KT +1608			
	C303	nsp	CK73F1E104ZT +1608			
	C304	nsp	CK73B1H102KT +1608			
	C305	nsp	CK73F1E104ZT +1608			
	C306	nsp	CK73B1H102KT +1608			
	C307	00D 257 2018 900	CS77B1A100MT(NOJ)			
	C308	nsp	CK73F1E104ZT +1608			
	C309	nsp	CK73F1H103ZT +1608			
	C310	nsp	CK73F1E104ZT +1608			
	C311	00D 254 4740 976	CE67W1C100MT(GV)			
	C313,314	nsp	CK73F1E104ZT +1608			
	C315	00D 254 4737 947	CE04W1H010MT(SF)			
	C316	nsp	CK73F1E104ZT +1608			
	C317	00D 257 0506 922	CC73CH1H750JT +1608			
	C319,320	nsp	CK73F1H103ZT +1608			
	C322	00D 254 4740 976	CE67W1C100MT(GV)			
	C323	nsp	CK73B1H102KT +1608			
	C324	00D 254 4732 955	CE04W0J221MT(SF)			
	C325	nsp	CK73F1H103ZT +1608			
	C326	nsp	CK73F1E104ZT +1608			
	C327	nsp	CK73F1H103ZT +1608			
	C328	nsp	CK73B1E104KT +1608			
	C329	nsp	CK73F1H103ZT +1608			
	C331	nsp	CK73F1E104ZT +1608			
	C332	nsp	CK73F1H103ZT +1608			
	C401	nsp	CK73B1H102KT +1608			
	C403	nsp	CK73B1H102KT +1608			
	C404,405	00D 254 4734 953	CE04W1C101MT(SF)			
	C406-409	nsp	CK73F1E104ZT +1608			
	C410,411	nsp	CK73B1H222KT +1608			
	C412	nsp	CK73B1E104KT +1608			
	C413-415	nsp	CK73F1H103ZT +1608			

Ref. No.	Part No.	Part Name	Remarks	Q'ty	New
C501-504	nsp	CK73F1H103ZT +1608			
C505,506	nsp	CK73B1H102KT +1608			
C507-510	00D 254 4734 953	CE04W1C101MT(SF)			
C511-513	nsp	CK73F1H103ZT +1608			
C514-516	nsp	CK73F1E104ZT +1608			
C517	nsp	CK73B1E104KT +1608			
C518-521	nsp	CK73F1H103ZT +1608			
C522	00D 254 4734 953	CE04W1C101MT(SF)			
C701,702	nsp	CK73F1H103ZT +1608			
C703-705	nsp	CC73CH1H101JT +1608			
C708-711	00D 254 4743 902	CE67W1H0R1MT(GV)			
C712	00D 254 4739 916	CE67W1A470MT(GV)			
C713	nsp	CK73F1E104ZT +1608			
C714	nsp	CK73B1H102KT +1608			
C715	nsp	CK73F1H103ZT +1608			
C716	nsp	CK73F1E104ZT +1608			
C751,752	nsp	CK73F1H103ZT +1608			
C803	nsp	CC73CH1H101JT +1608			
C806	nsp	CC73CH1H101JT +1608			
C807	00D 254 4740 976	CE67W1C100MT(GV)			
C808,809	nsp	CK73F1E104ZT +1608			
C810	nsp	CK73B1H102KT +1608			
C811	00D 254 4740 918	CE67W1C330MT(GV)			
C812	nsp	CC73CH1H101JT +1608			
C813,814	nsp	CK73F1H103ZT +1608			
C815	00D 254 4739 916	CE67W1A470MT(GV)			
C816-819	nsp	CK73F1H103ZT +1608			
C820,821	nsp	CK73F1E104ZT +1608			
C822	00D 254 4740 976	CE67W1C100MT(GV)			
C823	nsp	CK73B1H102KT +1608			
C824	nsp	CK73F1E104ZT +1608			
C825	nsp	CK73F1H103ZT +1608	for E2		
C826,827	00D 254 4740 976	CE67W1C100MT(GV)	for E2		
C828	nsp	CC73CH1H561JT +1608	for E2		
C829,830	nsp	CC73CH1H220JT +1608	for E2		
C831	nsp	CK73F1H103ZT +1608	for E2		
C832	00D 254 4739 916	CE67W1A470MT(GV)	for E2		
C833	nsp	CC73CH1H331JT +1608	for E2		
C834	nsp	CK73F1H103ZT +1608	for E2		
C835	nsp	CK73F1H103ZT +1608			
C836	nsp	CK73B1H102KT +1608			
C837	00D 254 4740 976	CE67W1C100MT(GV)			
C838	nsp	CK73F1E104ZT +1608			
C839	nsp	CK73F1H103ZT +1608			
C840	nsp	CK73B1E104KT +1608			
C841	nsp	CK73B1H103KT (1608) +1608			
C842,843	nsp	CK73F1H103ZT +1608			
C844	nsp	CK73F1E104ZT +1608			
C845	nsp	CK73F1H103ZT +1608			
C846	nsp	CK73B1H102KT +1608			
C847	nsp	CK73F1E104ZT +1608			
C848	nsp	CK73F1H103ZT +1608			
C951	nsp	CK73B1H102KT +1608			
C952	nsp	CK73F1H103ZT +1608			
C953-955	nsp	CK73F1E104ZT +1608			
C956	00D 254 4738 917	CE67W0J221MT(GV)			
C957	00D 257 2018 900	CS77B1A100MT(NOJ)			

	Ref. No.	Part No.	Part Name	Remarks	Q'ty	New
<b>OTHERS PARTS GROUP</b>						
	AS103	nsp	RADIATOR			
	AS201	nsp	LED SPACER			
	AS202-204	nsp	FL SPACER			
	AS205	nsp	LED SPACER			*
	CW051	nsp	5P PH-SAN CON.CORD			
	CW052	nsp	5P ZH-SAN CON.CORD			
	CX055	nsp	5P CON.BASE TUC-P			
	CX141,142	nsp	14P SOCKET(9162S)			*
	CX154	00D 205 0770 045	15P FFC BASE(SIDE)			
	CX303	nsp	30P CONN. SOCKET			
	CY054	nsp	5P CONN.BASE(KR-PH)			
	CY055	nsp	5P CON.SOCKET TUC-P			
	CY091	nsp	9P CON.SOCKET TUC-P			
	CY121,122	nsp	12P CON.SOCKET TUC-P			
	CY123,124	nsp	12P SOCKET(9120)			
	CY141,142	nsp	14P PIN HEADER(9220B)			*
	CY151	nsp	15P PIN HEADER(9120)			
	CY153	nsp	15P CON.SOCKET TUC-P			
	CY171	00D 205 1100 038	17P FFC BASE(P=1)			
	CY211	00D 205 1006 022	21P FFC BASE (P=1)			
	CY303	00D 205 0612 035	30P CONN.BASE			
	CY401	00D 205 1274 906	40P CON.PLUG 9828B			
	FB104	nsp	BEADS INDUCTOR TAPE			
	FB105-110	nsp	CHIP EMIFIL(11A121) +1608			
	FB111-114	nsp	BEADS INDUCTOR TAPE			
	FB201-206	nsp	CHIP EMIFIL(11A121) +1608			
	FB701-705	nsp	E.FIL(BLM21PG221SN1)+2125			
	FB801,802	nsp	CHIP EMIFIL(11A121) +1608			
	FB803,804	nsp	E.FIL(BLM21PG221SN1)+2125			
	FB951	nsp	E.FIL(BLM21PG221SN1)+2125			
	JK101	00D 205 1355 003	25P DSUB(MALE)			
	JK201,202	00D 204 8636 010	MINI JACK(ST SW)			
	JK801	00D 204 8637 006	MINI JACK (STEREO)			
	JK802	00D 204 8729 008	2P MINI JACK			
	JK851	00D 204 8714 000	USB CONNECTOR(TOPYANG BLACK)			
	JK901	00D 205 1305 008	9P D-SUB CONNECTOR			
	L101,102	00D 235 0184 014	INDUCTOR 10UH(7208M)			
	S201-207	00D 212 5611 903	TACT SWITCH(TAPE H5)			
	S208	00D 212 0527 005	ROTARY ENCODER			
	S751	00D 212 1204 000	SLIDE SW(SSAA110500)			
△	T101	00D 231 8084 004	DC-DC TRANS(ST3193)			
	W301,302	nsp	1P SIN CORD ASSY			
	W701	nsp	M3 SCREW TERMINAL			
	W951	nsp	M3 SCREW TERMINAL			
	X801	00D 399 1009 007	X-TAL(S-4.332-14)	for E2		
		nsp	3X8 CPS(SW,W) ZNP			

## 1U-3811A/B/C D.AMP/SMPS P.W.B. UNIT ASS'Y

Ref. No.	Part No.	Part Name	Remarks	Q'ty	New
<b>SEMICONDUCTORS GROUP</b>					
IC101-103	00D 263 1277 909	RC4580IDR			*
IC201	00D 262 3502 909	TAS5066PAGRG4			
IC202	00D 262 3504 907	SN74HCU04APWR			
IC203,204	00D 262 3501 900	PCM1803DBR			
IC205	00D 263 1100 005	KIA7805API-U/P			
IC206	00D 262 3503 911	TAS5142DKD			
IC207	00D 262 3503 908	TAS5121DKDR			
IC208	00D 262 3082 924	BD4730G-TR			
IC401	00D 265 0118 007	STR-F6267S(LF1351)	for E2		
IC401	00D 265 0116 009	STR-F6238S(LF1351)	for E3, JP		
IC402	00D 262 3508 903	SPI-8002TW			
IC403	00D 263 1100 021	KIA7812API-U/P			
IC404	00D 263 1099 022	KIA7912PI-U/P			
IC405	00D 263 1155 005	SE-B2(LF12)			
IC406	00D 263 1100 063	KIA7809API-U/P			
IC407	00D 262 3047 008	PC123Y22			
TR101,102	00D 273 0460 905	KTC2875-B-RTK/P			
TR103,104	00D 269 0192 902	KRC102S-RTK/P (10K-10K)			
TR105	00D 273 0460 905	KTC2875-B-RTK/P			
TR110	00D 269 0184 907	KRA102S-RTK/P (10K-10K)			
TR201	00D 273 0464 901	KTC3875S-GR-RTK/P			
TR202,203	00D 271 0312 905	KTA1504S-GR-RTK/P			
TR204	00D 273 0464 901	KTC3875S-GR-RTK/P			
TR205	00D 269 0192 902	KRC102S-RTK/P (10K-10K)			
TR206	00D 273 0468 907	KTC3199-GR-AT/P			
TR207	00D 269 0184 907	KRA102S-RTK/P (10K-10K)			
TR208	00D 269 0192 902	KRC102S-RTK/P (10K-10K)			
TR401	00D 273 0468 907	KTC3199-GR-AT/P			
TR402,403	00D 273 0464 901	KTC3875S-GR-RTK/P			
TR404	00D 271 0320 900	KTA1517-GR-RTK/P			
TR405	00D 274 0160 907	2SD2144STPU			
TR406,407	00D 271 0320 900	KTA1517-GR-RTK/P			
TR501,502	00D 269 0192 902	KRC102S-RTK/P (10K-10K)			
D101	00D 276 0401 905	1SS133T77 (TAPE)			
D102-107	00D 276 0773 905	RB501V-40 +2125			
D113	00D 276 0401 905	1SS133T77 (TAPE)			
D201-206	00D 276 0750 902	RB521S-30TE61 +REF			
D207-212	00D 276 0401 905	1SS133T77 (TAPE)			
D213,214	00D 276 0717 903	1SS355 TE-17 +C			
D215,216	00D 276 0401 905	1SS133T77 (TAPE)			
D217	00D 276 0401 905	1SS133T77 (TAPE)	for E3, JP		
D401,402	00D 276 0401 905	1SS133T77 (TAPE)			
D403,404	00D 276 0750 902	RB521S-30TE61 +REF			
D405	00D 276 0802 009	GS1B660			
D406-410	00D 276 0750 902	RB521S-30TE61 +REF			
D411,412	00D 276 0727 919	AL01ZT (WK)			
D413	00D 276 0758 001	SARS03			
D414	00D 276 0727 919	AL01ZT (WK)			
D415,416	00D 276 0772 003	1N4004			
D417	00D 276 0401 905	1SS133T77 (TAPE)			
D418,419	00D 276 0782 909	RN1Z			
D420	00D 276 0832 008	FMX-G22S			



	Ref. No.	Part No.	Part Name	Remarks	Q'ty	New
	D423	00D 276 0401 905	1SS133T77 (TAPE)			
	D424	00D 276 0773 905	RB501V-40 +2125			
	D425	00D 276 0401 905	1SS133T77 (TAPE)			
	D426,427	00D 276 0825 905	SFPB-74V			
	ZD201,202	00D 276 0823 907	P4SMAJ33CA			
	ZD401	00D 276 0761 975	MTZJ18B T77	for E3, JP		
	LD501	00D 393 9666 004	LED(RED) SLI-560UT			
	TH401	00D 279 0045 001	NTPAJ6R0LDKB0			
<b>RESISTORS GROUP</b>						
	R261	00D 247 0059 951	RM73B--2R7FT(RL1220 1/4) +2125			
	R264	00D 247 0059 951	RM73B--2R7FT(RL1220 1/4) +2125			
	R401	00D 242 2009 001	RC1/2 225K B(UL)			
	R402	00D 242 2009 001	RC1/2 225K B(UL)	for E3		
	R404	00D 244 2051 961	RS14B3A101JNBST(S)			
	R411	00D 243 2094 019	RW99=3DR22JF	for E2		
	R411	00D 243 2094 035	RW99=3DR10JF	for E3, JP		
	R412	00D 243 2094 019	RW99=3DR22JF	for E2		
	R412	00D 243 2094 006	RW99=3DR12JF	for E3, JP		
	R414	00D 244 2682 916	RS14B3D104JNBST(S)	for E2		
	R414	00D 244 2682 932	RS14B3D333JNBST(S)	for E3, JP		
	R419	00D 241 2315 912	RD14B2E100GFRST			
	R424	00D 244 2051 990	RS14B3A472JNBST(S)			
	R427	00D 247 2019 902	RM73B--102FT +1608			
	R428	00D 245 2385 928	RN14K2E393FT(EROS2)			
	R449	00D 243 2094 019	RW99=3DR22JF			
	R450,451	00D 243 2094 035	RW99=3DR10JF			
	R453	00D 244 2675 732	RS14B3D104JNBF(ERG)	for E2		
	R453	00D 244 2675 716	RS14B3D683JNBF (ERG)	for E3, JP		
<b>CAPACITORS GROUP</b>						
	C101-104	00D 254 4722 981	CE04W1H100MT(GR)			
	C105,106	nsp	CC73CH1H101JT +1608			
	C107,108	00D 254 4722 981	CE04W1H100MT(GR)			
	C109,110	nsp	CK73B1E104KT +1608			
	C111,112	00D 254 4722 981	CE04W1H100MT(GR)			
	C113	nsp	CK73B1H102KT +1608			
	C114,115	00D 254 4722 981	CE04W1H100MT(GR)			
	C116	nsp	CK73B1H102KT +1608			
	C118,119	00D 254 4722 981	CE04W1H100MT(GR)			
	C121	nsp	CK73B1E104KT +1608			
	C122	00D 254 4722 981	CE04W1H100MT(GR)			
	C123	nsp	CK73B1H102KT +1608			
	C124	nsp	CK73B1E104KT +1608			
	C125	00D 254 4722 981	CE04W1H100MT(GR)			
	C127	nsp	CC73CH1H101JT +1608			
	C128	00D 254 4722 981	CE04W1H100MT(GR)			
	C129,130	nsp	CK73B1E104KT +1608			
	C131	00D 254 4722 981	CE04W1H100MT(GR)			
	C132	00D 254 4722 936	CE04W1HR47MT(GR)			
	C133	nsp	CK73B1H102KT +1608			

	Ref. No.	Part No.	Part Name	Remarks	Q'ty	New
	C134	00D 254 4722 981	CE04W1H100MT(GR)			
	C135	nsp	CC73CH1H101JT +1608			
	C136	nsp	CC73CH1H471JT +1608			
	C137	00D 254 4722 981	CE04W1H100MT(GR)			
	C138,139	nsp	CK73B1E104KT +1608			
	C201	nsp	CK73B1H102KT +1608			
	C203	nsp	CK73B1E104KT +1608			
	C204	nsp	CC73CH1H5R0CT +1608			
	C205-207	00D 254 4722 981	CE04W1H100MT(GR)			
	C208-210	nsp	CK73B1H103KT (1608) +1608			
	C211-213	00D 254 4722 981	CE04W1H100MT(GR)			
	C214,215	nsp	CK73B1E104KT +1608			
	C216,217	00D 254 4722 981	CE04W1H100MT(GR)			
	C218,219	nsp	CK73B1E104KT +1608			
	C220	00D 254 4722 981	CE04W1H100MT(GR)			
	C221	nsp	CK73B1E104KT +1608			
	C222	00D 254 4722 981	CE04W1H100MT(GR)			
	C223	nsp	CK73B1E104KT +1608			
	C224	nsp	CK73B1A224KT +1608			
	C225	00D 254 4722 981	CE04W1H100MT(GR)			
	C226	nsp	CK73B1E223KT +1608			
	C227	00D 254 4711 905	CE04W1A471MT HB5(KY)			
	C228	nsp	CK73B1H103KT (1608) +1608			
	C232	nsp	CK73B1E104KT +1608			
	C233	00D 254 4759 909	CE04W1H100MT E11(KY)			
	C234	nsp	CK73B1E104KT +1608			
	C235	00D 254 4759 909	CE04W1H100MT E11(KY)			
	C236	nsp	CK73B1A224KT +1608			
	C237	nsp	CK73B1H103KT (1608) +1608			
	C238	00D 254 4759 909	CE04W1H100MT E11(KY)			
	C240	nsp	CK73B1H103KT (1608) +1608			
	C241	00D 254 4651 900	CE04W0J331MT F11(KY)			
	C243	nsp	CK73B1A224KT +1608			
	C244,245	00D 254 4759 909	CE04W1H100MT E11(KY)			
	C248	nsp	CK73B1E104KT +1608			
	C249	00D 254 4718 953	CE04W1C221MT(GR)			
	C250,251	nsp	CK73B1H103KT (1608) +1608			
	C252	00D 254 4718 953	CE04W1C221MT(GR)			
	C253,254	nsp	CK73B1E104KT +1608			
	C259	nsp	CK73B1E104KT +1608			
	C260,261	00D 254 4759 909	CE04W1H100MT E11(KY)			
	C262-266	nsp	CK73B1E104KT +1608			
	C267	00D 257 0516 925	CK73B1E333KT +1608			
	C270,271	00D 257 0516 925	CK73B1E333KT +1608			
	C274	00D 257 0516 925	CK73B1E333KT +1608			
	C275,276	nsp	CK73B1E104KT +1608			
	C277	nsp	CK73B1H103KT (1608) +1608			
	C278	nsp	CK73B1E104KT +1608			
	C279	nsp	CK73F1C105ZT +2125			
	C280	00D 257 0516 925	CK73B1E333KT +1608			
	C281,282	nsp	CK73B1H104KT +2125			
	C283	00D 257 0516 925	CK73B1E333KT +1608			
	C284	nsp	CK73F1C105ZT +2125			
	C285-288	nsp	CK73B1H102KT +1608			
	C289,290	00D 254 4718 953	CE04W1C221MT(GR)			
	C299-302	nsp	CK73B1H103KT (1608) +1608			

	Ref. No.	Part No.	Part Name	Remarks	Q'ty	New
	C303-306 C307 C308	00D 254 4641 907 nsp nsp	CE04W1H470MT F11(LXZ CK73B1H104KT +2125 CC73CH1H5R0CT +1608			
	C309,310 C311 C312 C313,314 C316	nsp nsp nsp nsp nsp	CK73B1H104KT +2125 CK73B1H103KT (1608) +1608 CK73B1H104KT +2125 CK73B1H103KT (1608) +1608 CK73B1H103KT (1608) +1608			
	C317,318 C319,320 C323 C324 C325	nsp nsp 00D 257 3013 933 00D 254 4714 708 00D 257 3013 933	CK73B1H104KT +2125 CK73B1H103KT (1608) +1608 CF73=1H104JT(ECHUC9) +C CE04W1V222MC LN3(KY) CF73=1H104JT(ECHUC9) +C			
	C326 C335 C336-338 C339 C401	00D 254 4714 708 nsp 00D 256 1067 904 nsp 00D 253 8026 703	CE04W1V222MC LN3(KY) CK73B1H102KT +1608 CF93A2A474JT(ECQV) CK73B1E104KT +1608 CK45E2EAC472MC			
	C402,403 C405 C405 C405 C406	nsp 00D 256 8039 003 00D 256 8039 016 00D 256 8039 029 00D 256 8039 016	RM73B--0R0KT +1608 CF99--2EAC104K(LEMV) CF99--2EAC224K(LEMV) CF99--2EAC334K(LEMV) CF99--2EAC224K(LEMV)	for E2 for E3 for JP for E3		
	C406 C407 C408-410 C408-410 C411	00D 256 8039 029 nsp 00D 253 8035 707 00D 253 8035 710 00D 253 8030 003	CF99--2EAC334K(LEMV) CK73B1H103KT (1608) +1608 CK45E2EAC102MC(KY) CK45E2EAC222MC(KY) CK45B3D681KC(ECKA)	for JP for E2 for E3, JP for E2		
	C411 C412 C412 C413,414 C418,419	00D 255 4261 704 00D 256 8039 016 00D 256 8039 029 00D 256 8039 003 nsp	CQ93P2J222KC(ECQP) CF99--2EAC224K(LEMV) CF99--2EAC334K(LEMV) CF99--2EAC104K(LEMV) CK73B1E223KT +1608	for E3, JP for E3 for JP		
	C421 C422 C423 C425 C426-429	nsp nsp nsp 00D 254 4618 901 nsp	CK73B1H332KT +1608 CC73CH1H221JT +1608 CK73B1H103KT (1608) +1608 CE04W1H101MT H12(LXZ CK73B1H103KT (1608) +1608			
	C430 C431 C432 C432 C433	00D 254 4721 995 nsp 00D 254 6229 000 00D 254 6228 001 00D 254 4639 906	CE04W1V102MT(GR) CK73B1H103KT (1608) +1608 CE68W2G331M 35B(KMM) CE68W2D102M 35B(KMM) CE04W1H4R7MT(KMG)	for E2 for E3, JP		
	C434 C435 C435 C436 C437	nsp 00D 255 4261 717 00D 255 4261 762 00D 254 4728 707 nsp	CK73B1H102KT +1608 CQ93P2J332KC(ECQP) CQ93P2J103KC(ECQP) CE04W1E332M (GR) CK73B1E104KT +1608	for E2 for E3, JP		
	C439 C440 C441 C442 C442	00D 254 4718 940 nsp nsp 00D 253 8032 700 00D 253 8029 700	CE04W1C101MT(GR) CK73B1E104KT +1608 CK73B1C473KT +1608 CK45E2EAC102MC(KX) CK45F2EAC222MC (KX)	for E2 for E3, JP		
	C443 C444 C445	nsp 00D 254 2708 701 00D 255 4261 720	CK73B1E104KT +1608 CE04W1E471MC J16(KY) CQ93P2J472KC(ECQP)			

	Ref. No.	Part No.	Part Name	Remarks	Q'ty	New
	C446	00D 254 2708 701	CE04W1E471MC J16(KY)			
	C447,448	00D 254 4714 708	CE04W1V222MC LN3(KY)			
	C449	nsp	CK73B1H103KT (1608) +1608			
	C451-454	nsp	CK73B1H103KT (1608) +1608			
	C455,456	00D 254 4718 953	CE04W1C221MT(GR)			
	C457	nsp	CC73CH1H221JT +1608			
	C458-460	nsp	RM73B--0R0KT +1608			
	C461	nsp	CK73B1H105KT			
	C462	nsp	CK73B1H103KT (1608) +1608			
	C464,465	nsp	CK73B1E104KT +1608			
	C466	nsp	CK73B1H103KT (1608) +1608			
	C467	00D 254 4722 952	CE04W1H2R2MT(GR)			
	C468	nsp	CK73B1H103KT (1608) +1608			
	C469	00D 254 4711 905	CE04W1A471MT HB5(KY)			
	C470	nsp	CK73B1H103KT (1608) +1608			
	C471	00D 254 4712 700	CE04W1C471MC JC5(KY)			
	C472,473	nsp	CK73B1E104KT +1608			
	C474	nsp	CK73B1H103KT (1608) +1608			
	C475	nsp	CK73B1H102KT +1608			
	C476	nsp	CK73B1H103KT (1608) +1608			
	C477	nsp	CK73B1H102KT +1608			
	C479	nsp	CK73B1E104KT +1608			
	C481	nsp	CK73B1H102KT +1608			
	C482-484	nsp	RM73B--0R0KT +1608			
	C485	00D 253 8029 700	CK45F2EAC222MC (KX)			
	C502,503	nsp	CK73B1H103KT (1608) +1608			
	C504	00D 253 1210 901	CK45B1H104KT(RPER)			
	C506	nsp	CK73B1H102KT +1608			
	C516	nsp	CK73B1H103KT (1608) +1608			
	C518,519	nsp	CK73B1H102KT +1608			
	C520	nsp	CK73B1H103KT (1608) +1608			
	C524	nsp	CK73B1H103KT (1608) +1608			
	C525,526	00D 255 1264 908	CQ93M1H102JT(B)			
	C527	00D 253 1210 901	CK45B1H104KT(RPER)			
	C530,531	00D 255 1264 908	CQ93M1H102JT(B)			
<b>OTHERS PARTS GROUP</b>						
	AS401	nsp	HEAT SINK (MINI)			
	AS402	nsp	RADIATOR			
	AS403	nsp	RADIATOR			
	AS501	nsp	LED SPACER SUPPORT A			
	CX021	nsp	2P VH CON BASE (White)			
	CX022	nsp	2P VH CON BASE (Blue)			
	CX041	nsp	4P VH CON.BASE			
	CX081	nsp	8P CONN.BASE(KR-PH)			
	CX151	nsp	15P CONN.BASE(KR-PH)			
	CX251	00D 205 1356 002	25P DSUB(FEMALE)			
	CY021	nsp	2P VH CON BASE (White)			
	CY023	nsp	2P VH CON BASE (White)			
	CY041	nsp	4P VH CON.BASE			
	CY081	nsp	8P CONN.BASE(KR-PH)			
	CY151	nsp	15P CONN.BASE(KR-PH)			

	Ref. No.	Part No.	Part Name	Remarks	Q'ty	New
⚠	F401	00D 206 1099 045	FUSE(02153.15MXP/250V)	for E2		
⚠	F401	00D 206 1094 066	FUSE(233)T4AL125V	for E3, JP		
⚠	F402	00D 206 1096 048	FUSE(218)T3.15AL250V	for E2		
⚠	F402	00D 206 1094 053	FUSE(233)T3.15AL125V	for E3, JP		
	FB201-204	nsp	CHIP EMIFIL(11A121) +1608			
	FB205,206	nsp	BEADS INDUCTOR TAPE			
	FB207	nsp	E.FIL(BLM21PG221SN1)+2125			
	FB501	nsp	CHIP EMIFIL(11A121) +1608			
	FB502,503	nsp	BEADS INDUCTOR TAPE			
	FB504	nsp	CHIP EMIFIL(11A121) +1608			
	FB506-508	nsp	CHIP EMIFIL(11A121) +1608			
	FB509	nsp	BEADS INDUCTOR TAPE			
	FB510,511	nsp	CHIP EMIFIL(11A121) +1608			
	FB512-515	nsp	BEADS INDUCTOR TAPE			
	FF401,402	nsp	FUSE CLIP(TAPE)			
	FH401,402	nsp	FUSE CLIP(TAPE)			
	JK501	00D 205 1357 001	SP TERMINAL			
	L201	00D 235 0125 905	INDUCTOR(FLC32C220K)+3216			
	L202	00D 235 0192 006	INDUCTOR 7G14D-100M			
	L203	00D 231 0091 008	60NH(AIR COIL)			
	L204,205	00D 235 0192 006	INDUCTOR 7G14D-100M			
	L206	00D 231 0091 008	60NH(AIR COIL)			
	L207,208	00D 235 0192 006	INDUCTOR 7G14D-100M			
	L209-211	00D 231 0091 008	60NH(AIR COIL)			
	L212	00D 235 0192 006	INDUCTOR 7G14D-100M			
	L213	00D 231 0091 008	60NH(AIR COIL)			
	L215	00D 235 0192 006	INDUCTOR 7G14D-100M			
	L401,402	00D 239 0038 078	L.FILTER(HR28R-E333)	for E2		
	L401,402	00D 239 0038 052	L.FILTER(HR28R-E123)	for E3, JP		
	L404,405	00D 235 0185 903	INDUCTOR 47UH(7E10H)			
	RL201,202	00D 214 0217 010	RELAY(DS2SU12VDC)			
	RL401	00D 214 0242 001	RELAY(DLS9D1-O_M)			
⚠	T401	00D 233 6605 009	SW TRANS(E2/EK 3591)	for E2		*
⚠	T401	00D 233 6604 000	SW_TRANS(E3/EJ 3590)	for E3, JP		*
⚠	T402	00D 233 6615 002	POWER TRANS(MINI/E2)	for E2		*
⚠	T402	00D 233 6614 003	POWER TRANS(MINI/E3)	for E3		*
⚠	T402	00D 233 0747 002	POWER TRANS(MINI/J)	for JP		*
	W101	nsp	LUG PLATE			
	W201	nsp	LUG PLATE			
	W401-404	nsp	LUG PLATE			
	X201	00D 399 1114 905	X-TAL(L8450-24.576)			*
		nsp	3X12 CPS SW W			
		nsp	3X8 CPS(SW,W) ZNP			
		nsp	FUSE LABEL3.15A/125V	for E3, JP		
		nsp	FUSE LABEL(4A/125V)	for E3, JP		

# EXPLODED VIEW

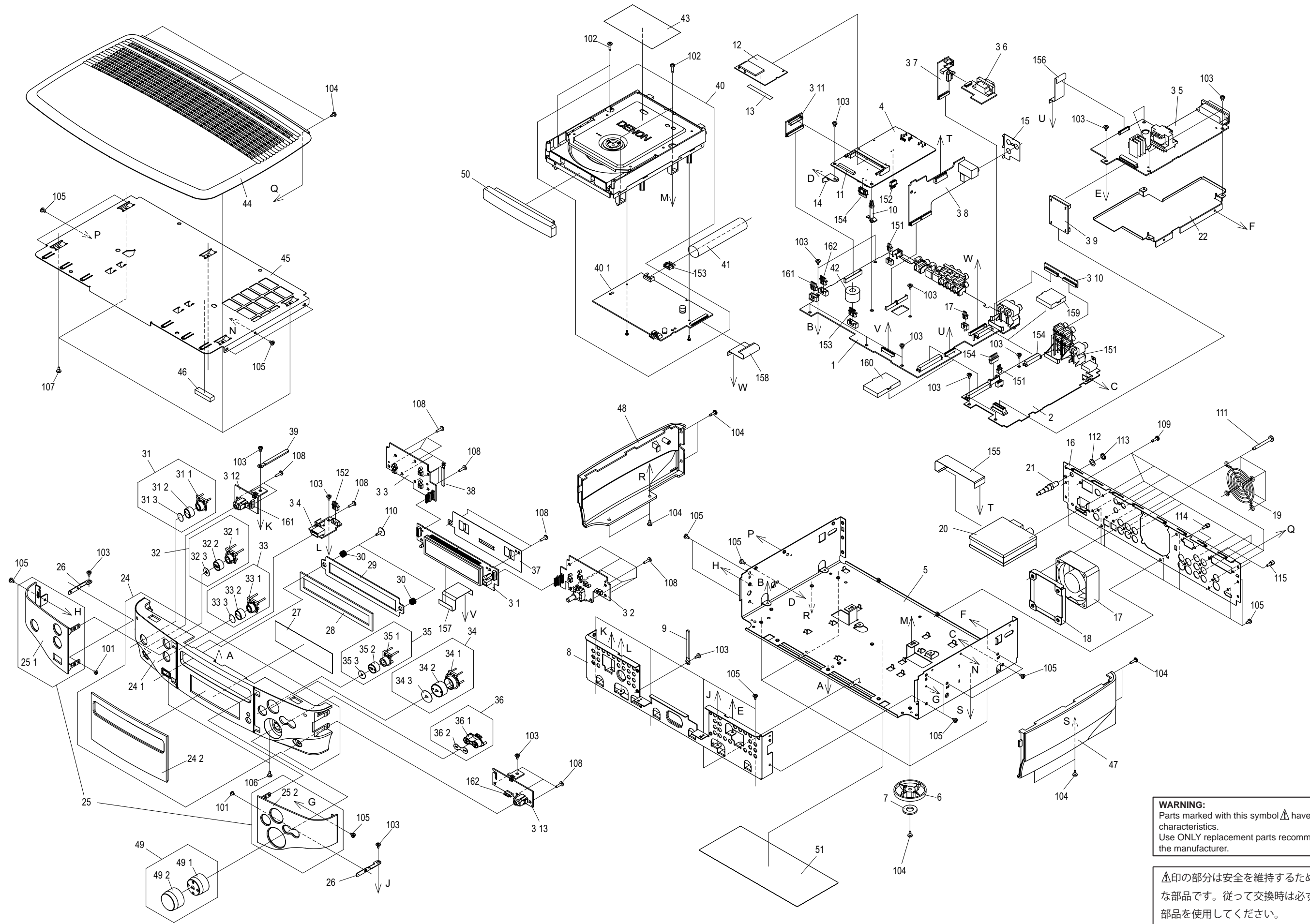

**WARNING:**  
 Parts marked with this symbol ⚠ have critical characteristics.  
 Use ONLY replacement parts recommended by the manufacturer.

⚠印の部分は安全を維持するために重要な部品です。従って交換時は必ず指定の部品を使用してください。

## PARTS LIST OF EXPLODED VIEW

\* 本表に "nsp" と記載されている部品は供給できません。

\* Parts for which "nsp" is indicated on this table cannot be supplied.

\* 本表に "nsp" と記載されている基板 ASS'Y は供給できません。基板 ASS'Y の修理の際には基板部品表を確認のうえ、交換部品を発注してください。

\* P.W.B. ASS'Y for which "nsp" is indicated on this table cannot be supplied. When repairing the P.W.B. ASS'Y, check the board parts table and order replacement parts.

\* 本表に記載されている部品は、補修用部品のため製品に使用している部品とは一部、形状、寸法などが異なる場合があります。

\* The parts listed below are for maintenance only, might differ from the parts used in the unit in appearances or dimensions.

**Note:** The symbols in the column "Remarks" indicate the following destinations.

E3 : U.S.A. & Canada model

E2 : Europe model

JP : Japan mode

Ref. No.	Part No.	Part Name	Remarks	Q'ty	New
1	00D1U-3808A	MAIN UNIT	for E2	1	*
1	00D1U-3808B	MAIN UNIT	for E3	1	*
1	00D1U-3808C	MAIN UNIT	for JP	1	*
2	00D1U-3809A	VIDEO UNIT		1	*
3	nsp	L.PWR/DISP UNIT	for E2	1	*
3	nsp	L.PWR/DISP UNIT	for E3, JP	1	*
3-1		DISPLAY CENTER UNIT		1	
3-2		DISPLAY RIGHT UNIT		1	
3-3		DISPLAY LEFT UNIT		1	
3-4		USB TERM. UNIT		1	
3-5		LOCAL POWER UNIT		1	
3-6		RS-232C UNIT		1	
3-7		SWITCH UNIT		1	
3-8		TUNER/R to R/IPOD UNIT		1	
3-9		IF-1 UNIT		1	
3-10		IF-2 UNIT		1	
3-11		IF-3 UNIT		1	
3-12		AUX IN UNIT		1	
3-13		H/P OUT UNIT		1	
4	00D1U-3777A	ETHERNET UNIT		1	*
5	nsp	MAIN CHASSIS		1	*
6	00D 104 0351 019	FOOT		4	
7	00D 461 1066 002	FELT		4	
8	nsp	FRONT BRACKET		1	*
9	nsp	CORD HOLDER (L50)		1	
10	nsp	LOCKING CARD SPACER		1	
11	nsp	SPACER		1	
12	00D 399 1100 003	WLAN MODULE(13CH)	for E2, JP	1	
12	00D 399 1099 004	WLAN MODULE(11CH)	for E3	1	
13	nsp	FFC ID SUB ASSY	for E3	1	*
14	nsp	PWB SUPPORT		1	*
15	nsp	EARTH PLATE		1	*
16	00D 105 1681 008	REAR PANEL		1	*
17	00D 421 0851 003	FAN 2410RL04WS10		1	*
18	nsp	FAN BRACKET		1	*
19	nsp	FAN GUARD		1	*
20	00D 216 0125 001	AM FM TUNER(E2)	for E2	1	
20	00D 216 0129 007	AM FM TUNER(E3 RDBS)	for E3	1	
20	00D 216 0127 009	AM FM TUNER(J)	for JP	1	
21	nsp	ANNTENA CABLE		1	
22	nsp	SHIELD COVER		1	*
★ 23	nsp	WIRE CLAMPER		1	
24	00D 146 2488 104	INNER PANEL ASSY		1	*
24-1	-	INNER PANEL		1	*
24-2	-	WINDOW		1	*
25	00D 144 3013 103	FRONT PANEL ASSY		1	*
25-1	-	FRONT PANEL L		1	*
25-2	-	FRONT PANEL R		1	*
26	nsp	EARTH BRACKET		2	*

Ref. No.	Part No.	Part Name	Remarks	Q'ty	New
27	00D 143 1283 000	DISPLAY FILTER		1	*
28	nsp	BLIND SHEET		1	
29	nsp	BLIND		1	
30	00D 463 0958 007	SPRING		2	
31	00D GEN 8518	POWER KNOB SUB ASSY		1	*
31-1	-	KNOB BASE		1	*
31-2	-	POWER KNOB CAP		1	
31-3	-	KNOB PLATE		1	*
32	00D GEN 8519	EJECT KNOB SUB ASSY		1	*
32-1	-	KNOB BASE		1	*
32-2	-	EJECT KNOB CAP		1	
32-3	-	EJECT KNOB PLATE		1	*
33	00D GEN 8520	FUNCTION KNOB SUB ASSY		1	*
33-1	-	KNOB BASE		1	*
33-2	-	FUNCTION KNOB CAP		1	
33-3	-	KNOB PLATE		1	*
34	00D GEN 8521	PLAY KNOB SUB ASSY		1	*
34-1	-	PLAY KNOB BASE		1	
34-2	-	PLAY KNOB CAP		1	
34-3	-	PLAY KNOB PLATE		1	*
35	00D GEN 8522	STOP KNOB SUB ASSY		1	*
35-1	-	STOP KNOB BASE		1	
35-2	-	STOP KNOB CAP		1	
35-3	-	STOP KNOB PLATE		1	*
36	00D GEN 8523	SKIP KNOB SUB ASSY		1	
36-1	-	SKIP KNOB		1	
36-2	-	SKIP KNOB PLATE		1	*
37	nsp	PROTECT SHEET		1	*
38	nsp	CORD HOLDER		1	
39	nsp	CORD HOLDER (L50)		1	
40	FG5 HPS 1MS	DVD MECHA UNIT		1	*
40-1	00D1U-3807	FEP P.W.B. UNIT		1	*
41	00D 415 0996 002	UL TUBE (12.7) BK		1	
42	00D 342 0040 003	FERRITE CRAMP081610N		1	
43	nsp	E2 LASER CAUTION	for E2	1	*
43	nsp	LABEL(A)	for E3	1	*
44	00D 146 2506 073	TOP COVER	for E2	1	*
44	00D 146 2506 060	TOP COVER	for E3	1	*
44	00D 146 2506 028	TOP COVER	for JP	1	*
45	nsp	TOP BRACKET		1	*
46	nsp	EMIGASKET RFSG100100	L=60mm	1	*
47	00D 146 2490 105	SIDE PANEL R		1	*
48	00D 146 2491 104	SIDE PANEL L		1	
49	00D 112 0959 001	VOLUME KNOB ASSY		1	*
49-1	-	VOLUME KNOB BUSH		1	*
49-2	-	VOLUME KNOB CAP		1	
50	00D 146 2492 006	LOADER PANEL		1	
51	nsp	RATING SHEET (E2)	for E2	1	*
51	nsp	RATING SHEET (E3)	for E3	1	*
51	nsp	RATING SHEET (J)	for JP	1	
★ 52	nsp	DATE LABEL		1	
★ 53	nsp	SERIAL NO. SHEET	for E3	1	*
★ 54	nsp	MANUFAC.(J)SUB ASSY	for JP	1	*

②



	Ref. No.	Part No.	Part Name	Remarks	Q'ty	New
<b>SCREWS</b>						
	101	ORD 471 3801 039	2X3 CBS-Z		2	
	102	ORD 473 7031 005	2.6X10 CBTS (S)-Z		4	
	103	ORD 473 7005 073	3X5 CBTS(S)Z		20	
	104	nsp	3X6 CBTS (S)-B		15	
	105	nsp	3X6 CBTS(S)-B		29	
	106	nsp	3X6 CFTS(S)-B		3	
	107	nsp	3X6 CBTS (P)-Z		5	
	108	nsp	3X10 CBTS (P)-B		21	
	109	nsp	FIXING SCREW		12	
	110	ORD 473 8044 004	SPECIAL SCREW		2	
	111	ORD 473 7035 001	4X35 CPTS(S)-B		4	*
	112	nsp	WASHER	for ANNTENA CABLE	1	
	113	nsp	NUT	for ANNTENA CABLE	1	
	114	nsp	HEX BOLT	for RS232C	2	
	115	nsp	HEX BOLT	for 25P DSUB	2	
<b>WIRES</b>						
	151	nsp	3P ZH-ZH SHIELD CORD	CX033	1	*
	152	nsp	5P PH-PH CON.CORD	CX054	1	*
	153	nsp	6P PH-PH CON.CORD	CX061	1	*
	154	nsp	7P PH-ZH CON.CORD	CX072	1	*
	155	00D 009 0184 033	15P FFC	CX154	1	*
	156	00D 009 0273 054	17P FFC(1.0)	CX171	1	*
	157	00D 009 0273 067	21P FFC(1.0)	CX211	1	*
	158	00D 009 0285 026	30P FFC(1.0)	CX301	1	*
	159	00D 205 1429 007	50P PLUG (377)	CX501	1	*
	160	00D 205 1431 008	80P PLUG (377)	CX801	1	*
	161	nsp	5P PH-SAN CON.CORD	CW051	1	*
	162	nsp	5P ZH-SAN CON.CORD	CW052	1	*

# EXPLODED VIEW OF DVD MECHANISM UNIT

**WARNING:**  
Parts marked with this symbol  have critical characteristics.  
Use ONLY replacement parts recommended by the manufacturer.

印の部分は安全を維持するために重要な部品です。従って交換時は必ず指定の部品を使用してください。

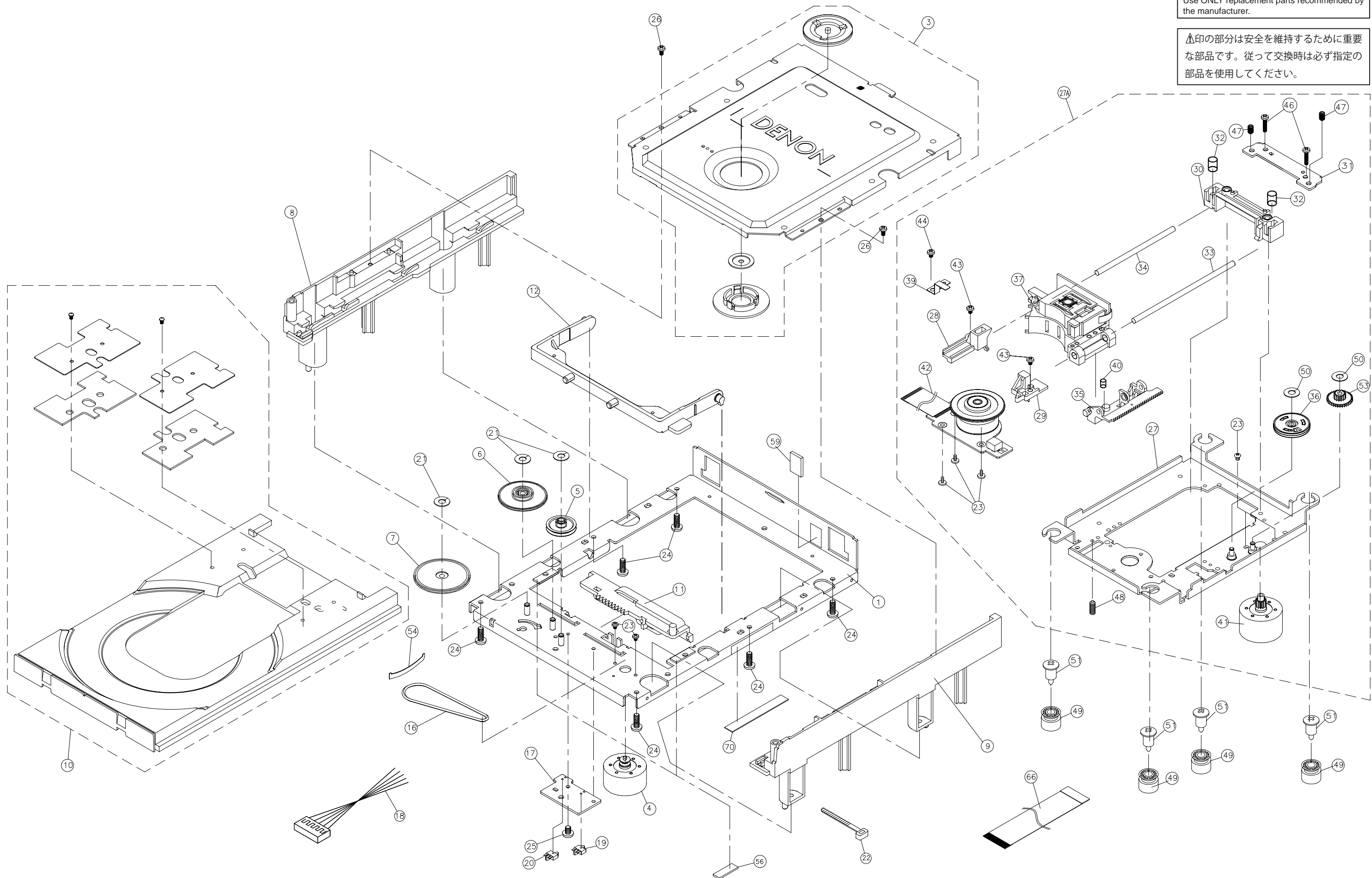

## PARTS LIST OF DVD MECHANISM UNIT

\* 本表に "nsp" と記載されている部品は供給できません。

\* Parts for which "nsp" is indicated on this table cannot be supplied.

\* 本表に記載されている部品は、補修用部品のため製品に使用している部品とは一部、形状、寸法などが異なる場合があります。

\* The parts listed below are for maintenance only, might differ from the parts used in the unit in appearances or dimensions.

Ref. No.	Part No.	Part Name	Remarks	Q'ty	New
1	nsp	MAIN CHASSIS ASS'Y		1	
3	00D 9KA 2A73 8	GUIDE CLAMP ASS'Y		1	
4	00D 9KC 2A00 3	LOADING MOTOR ASS'Y		1	
5	00D 9KC 2G02 9	LOADING GEAR		1	
6	00D 9KB 9G03 0	LOADING GEAR 2ND		1	
7	00D 9KB 9G03 1	LOADING GEAR 3RD		1	
8	nsp	SUB CHASSIS-L		1	
9	nsp	SUB CHASSIS-R		1	
10	00D 9KA 2A73 7	TRAY ASS'Y		1	
11	00D 9KC 1G00 3	SLIDE-CAM		1	
12	00D 9KC 1G00 4	TRAVERSE ARM		1	
16	00D 9KB 9G01 5	LOADING BELT		1	
17	nsp	SWITCH P.W.B.		1	
18	nsp	5P PH WIRE		1	
19	00D 9KS 01W2 04	SWITCH ESE22MH21		1	
20	00D 9KS 01W2 05	SWITCH ESE22MH23		1	
21	nsp	POLY.SLIT WASHER 2.6X6X0.25C		3	
22	00D 445 8004 007	WIRE CLAMPER		1	
23	nsp	PRECISION SCREW 1.7X2.2 TYPE3		2	
24	nsp	SCREW 2.6X6 CBTS(B)-Z		6	
25	nsp	PRECISION SCREW 2X3(S) TYPE3		1	
26	nsp	SCREW 2X6 CBTS(P)-Z		2	
27A	00D 9KA 2A69 3	TRAVERSE MECHA (FEED) ASS'Y	Assembled part	1	
23	-	PRECISION SCREW 1.7X2.2 TYPE3		5	
27	-	PU CHASSIS ASS'Y		1	
28	-	SHAFT HOLDER L		1	
29	-	SHAFT HOLDER R		1	
30	-	SHAFT TILT BASE-W		1	
31	-	SHAFT TILT PLATE-W		1	
32	-	TILT SPRING		2	
33	-	MAIN SHAFT		1	
34	-	SUB SHAFT		1	
35	-	PU RACK GEAR		1	
36	-	FEED GEAR 2ND ASS'Y		1	
37	-	PICK UP SF-HD65G		1	
39	-	SHAFT SPRING		1	
40	-	RACK GEAR SPRING		1	
41	-	FEED MOTOR ASS'Y		1	
42	-	T/T MOTOR ASS'Y		1	
43	-	SCREW 2.6X6 CBTS(S)-Z		2	
44	-	SCREW 2.6X4 CBTS(S)-Z		1	
46	-	SCREW 2.6X15 CFTS(S)-Z		2	
47	-	SCREW 3X4 BSS		2	
48	-	SCREW 3X8 BSS (A)		1	
50	-	POLY.SLIT WASHER 2.1X4X0.25C		2	
53	-	FEED GEAR 3RD		1	
49	00D 9KA 2G64 3	DAMPER		4	
51	00D 9KC 1H01 2	SPECIAL SCREW		4	
54	nsp	TRAY-SPRING-VXF		1	
56	nsp	RUBBER CUSHION		2	
59	nsp	TRAY-CUSHION		1	
66	00D 009 0276 006	24P FFC(0.5)		1	
70	nsp	TAPE W10X45 (NITTO NO.156)		1	

# POINTS OF GREASING

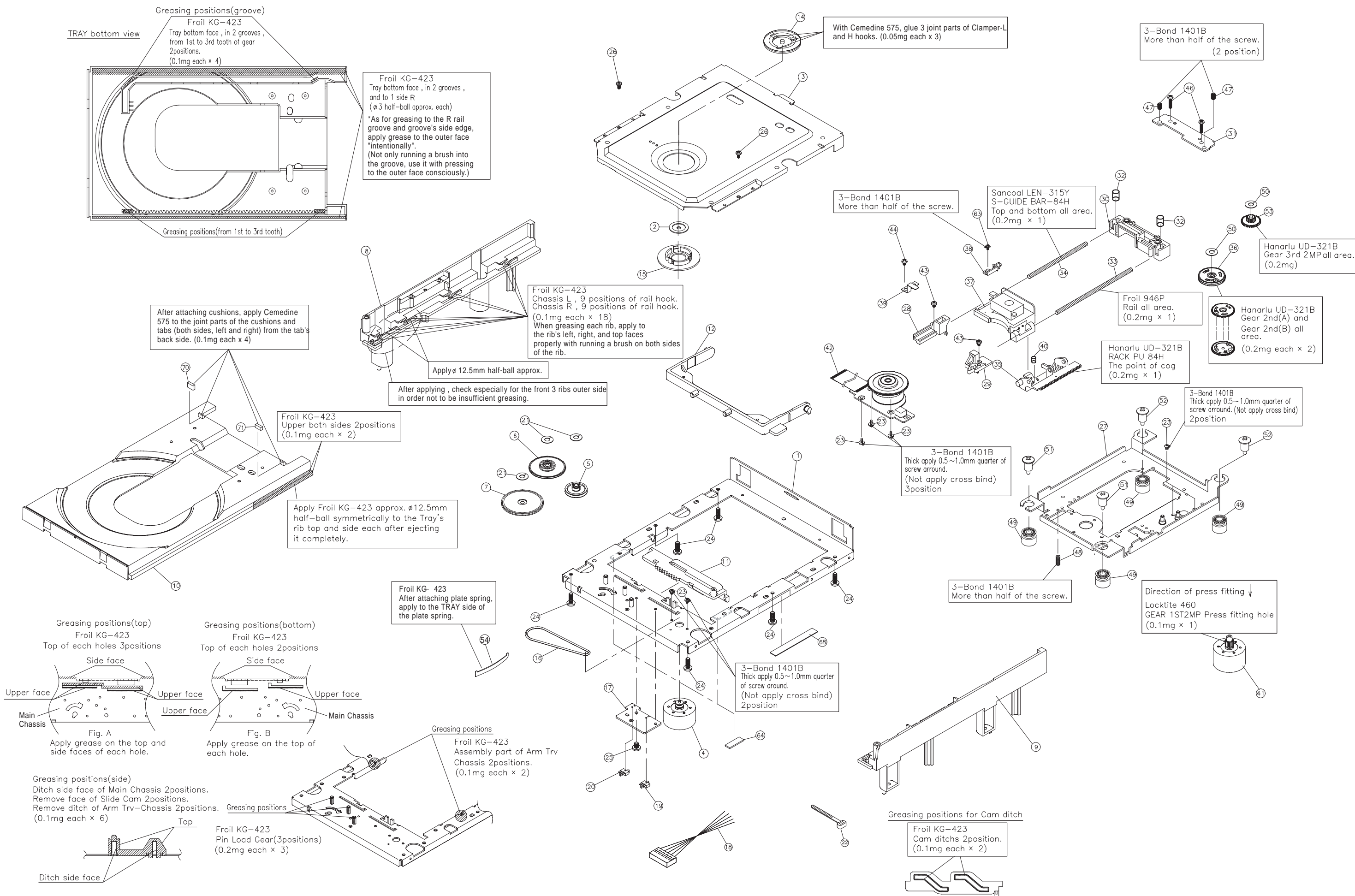

## DSW-S302 PARTS LIST OF EXPLODED VIEW

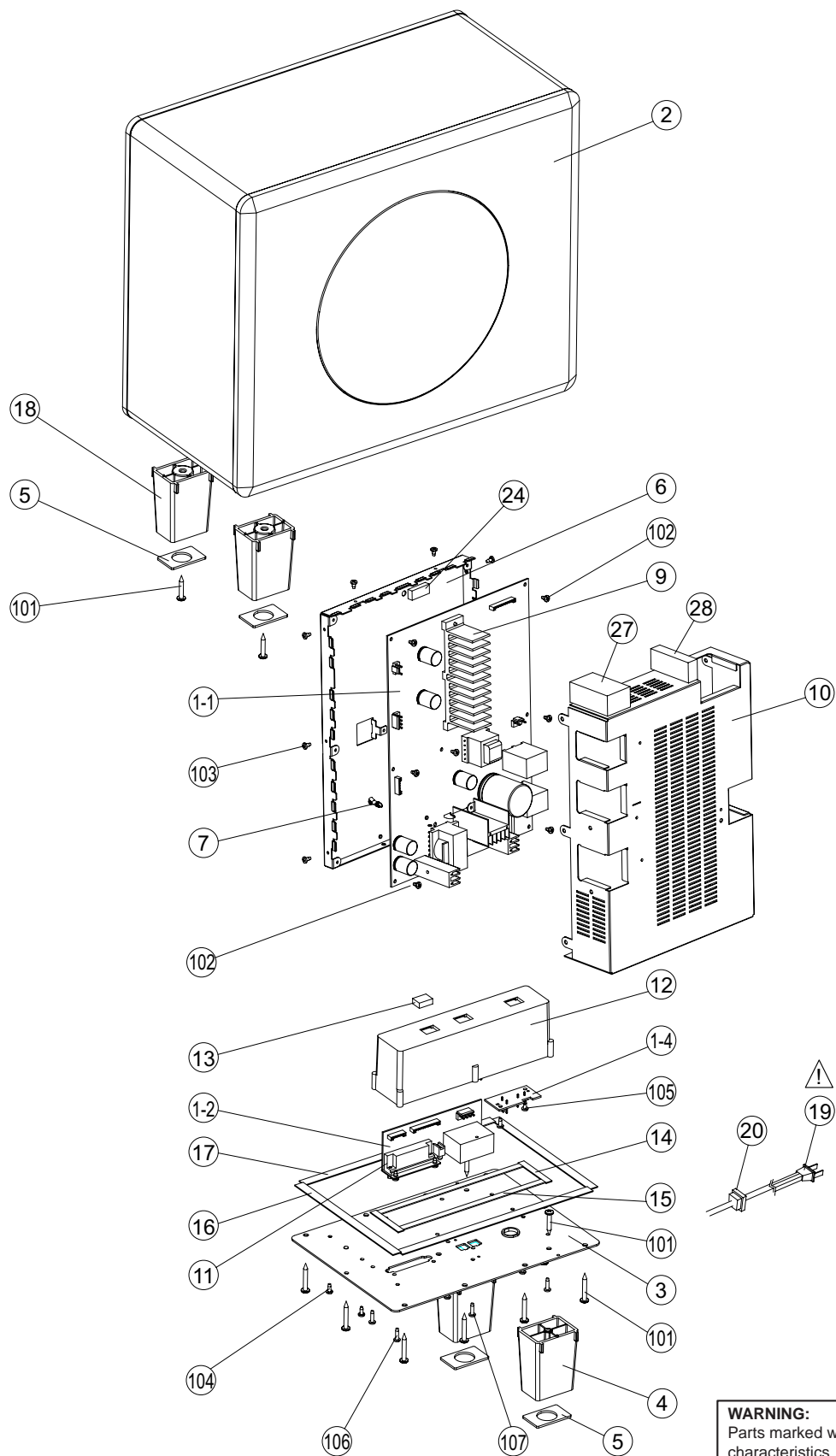

**WARNING:**  
Parts marked with this symbol  have critical characteristics.  
Use **ONLY** replacement parts recommended by the manufacturer.

印の部分は安全を維持するために重要な部品です。従って交換時は必ず指定の部品を使用してください。

## DSW-S302 PARTS LIST OF EXPLODED VIEW

\* 本表に "nsp" と記載されている部品は供給できません。

\* Parts for which "nsp" is indicated on this table cannot be supplied.

\* 本表に "nsp" と記載されている基板 ASS'Y は供給できません。基板 ASS'Y の修理の際には基板部品表を確認のうえ、交換部品を発注してください。

\* P.W.B. ASS'Y for which "nsp" is indicated on this table cannot be supplied. When repairing the P.W.B. ASS'Y, check the board parts table and order replacement parts.

\* 本表に記載されている部品は、補修用部品のため製品に使用している部品とは一部、形状、寸法などが異なる場合があります。

\* The parts listed below are for maintenance only, might differ from the parts used in the unit in appearances or dimensions.

**Note:** The symbols in the column "Remarks" indicate the following destinations.

E3 : U.S.A. & Canada model

E2 : Europe model

JP : Japan model

Ref. No.	Part No.	Part Name	Remarks	Q'ty	New	
1	nsp	D.AMP/SMPS UNIT(E2)	for E2	1	*	
	nsp	D.AMP/SMPS UNIT(E3)	for E3	1	*	
	nsp	D.AMP/SMPS UNIT(J)	for JP	1	*	
	1-1	SMPA/AMP UNIT		1		
	1-2	I/F UNIT		1		
1-4		AC I/F UNIT		1		
2	00D 101 2667 003	DSWS302 CABINET ASSY		1	*	
3	00D 105 1680 106	REAR PANEL		1	*	
4	00D 104 0354 003	FOOT(REAR)		2	*	
5	00D 461 1300 001	FELT		4	*	
6	nsp	MAIN BRACKET		1	*	
7	nsp	P.W.B.HOLDER (H=12)		1	*	
9	nsp	HEAT SINK		1	*	
10	nsp	SHIELD COVER		1	*	
11	nsp	CONNECTOR BRACKET		1	*	
12	nsp	TERMINAL COVER		1	*	
13	00D 445 0084 009	CORD BUSH		3	*	
14	nsp	PEF SHEET(7x48)		2	*	
15	nsp	PEF SHEET(7x177)		2	*	
16	nsp	PEF SHEET(10x180)		2	*	
17	nsp	PEF SHEET(10x233)		2	*	
18	00D 104 0353 004	FOOT(FRONT)		2	*	
△	19	00D 206 2244 006	AC CORD E2withCON(V)	for E2	1	
△	19	00D 206 2245 005	AC CORD E3withCON(V)	for E3	1	
△	19	00D 206 2248 002	AC CORD JwithCON (V)	for JP	1	
	20	00D 445 0131 004	CORD BUSH(SR-5K4)		1	
★	21	00D 461 1316 008	PEF SHEET(10x10)		1	*
★	22	nsp	SPACER(CPVS-0.5F)		2	*
★	23	00D 342 0040 003	FERRITE CRAMP081610N	CX041	1	
	24	nsp	PWB PAD		1	*
★	25	nsp	PEF SHEET(10x15)		5	*
★	26	nsp	PEF SHEET(30x120)		4	*
	27	nsp	CABINET PAD(70X50)		1	*
	28	nsp	CABINET PAD(70X15)		1	*
★	29	nsp	RATING SHEET(E2)		1	*
★	29	nsp	RATING SHEET(E3)		1	*
★	29	nsp	RATING SHEET(J)		1	*
★	30	nsp	DATE LABEL		1	
<b>wires</b>						
	51	00D 203 6644 001	4P VH-VH CON.CORD	CX04-1CY042	1	*
	52	00D 204 3021 002	8P PH-PH CON.CORD	CX081-CY082	1	*
	53	00D 203 2447 008	2P VA-VA CON.CORD	CX021-CY021	1	*
	54	00D 204 6821 018	15P PH-PH CON.CORD	CX151-CY152	1	*

	Ref. No.	Part No.	Part Name	Remarks	Q'ty	New
<b>screws</b>						
	101	ORD 473 3809 011	4X25 CBTS (1)		14	
	102	nsp	3X6 CBTS(S)-Z		7	
	103	nsp	3X6 CBTS(S)-B		10	
	104	nsp	3X8 CBTS (S)-B		9	
	105	nsp	3X10 CBTS (P)-Z		5	
	106	nsp	3X12 CBTS (P)-B		6	
	107	00D 477 0064 107	FIXING SCREW		1	
	★ 108	nsp	HEXAGON HEAD SCREW SET		2	

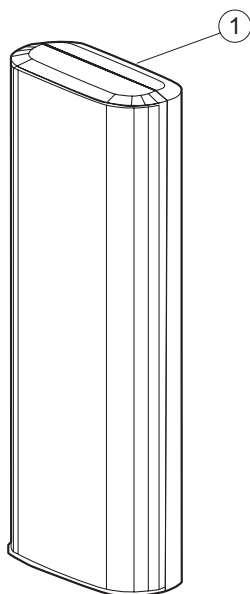
**SC-S302 PARTS LIST OF EXPLODED VIEW****SC-S302 PARTS LIST OF EXPLODED VIEW**

Ref. No.	Part No.	Part Name	Remarks	Q'ty	New
1	00D 949 0068 803	SPEAKER SYSTEM(L&R)		1	*



# PACKING VIEW

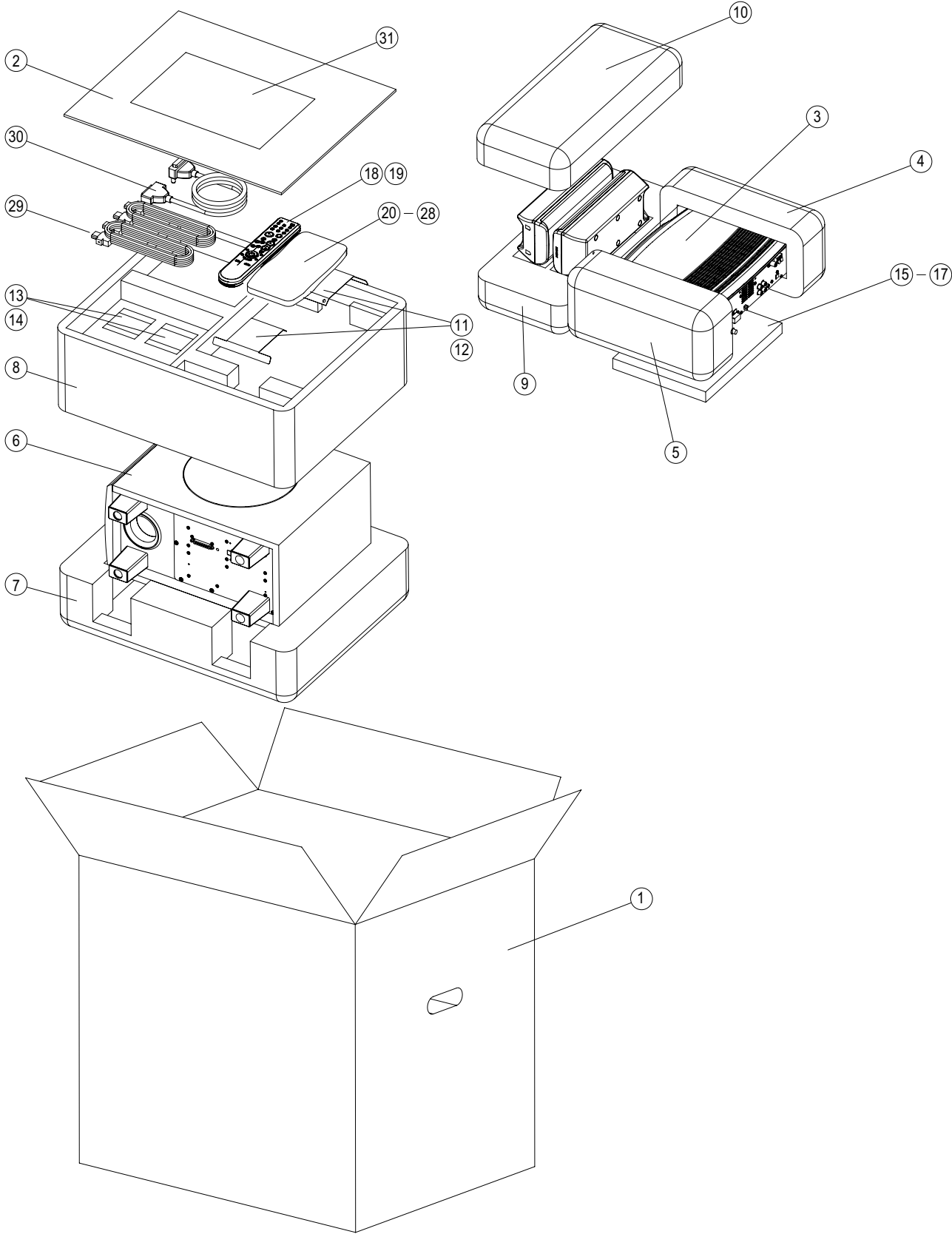

## PARTS LIST OF PACKING & ACCESSORIES

\* 本表に "nsp" と記載されている部品は供給できません。

\* Parts for which "nsp" is indicated on his table cannot be supplied.

\* 本表に記載されている部品は、補修用部品のため製品に使用している部品とは一部、形状、寸法などが異なる場合があります。

\* The parts listed below are for maintenance only, might differ from the parts used in the unit in appearances or dimensions.

**Note:** The symbols in the column "Remarks" indicate the following destinations.

E3 : U.S.A. & Canada model

E2 : Europe model

JP : Japan model

Ref. No.	Part No.	Part Name	Remarks	Q'ty	New	
1	00D 501 2372 035	MASTER CARTON	for E2	1	*	△
1	00D 501 2372 048	MASTER CARTON	for E3	1	*	△
1	00D 501 2372 051	MASTER CARTON	for JP	1	*	△
2	00D 502 1143 103	TOP SPACER		1	*	
3	00D 505 0312 057	CABINET COVER		1	*	
4	00D 503 1550 100	CUSHION (L)		1	*	
5	00D 503 1551 109	CUSHION (R)		1	*	
6	00D 505 0312 060	CABINET COVER		1	*	
7	00D 949 0069 006	CUSHION DSW(BOTTOM)		1	*	△
8	00D 949 0069 200	CUSHION DSW(UP)		1	*	△
9	00D 949 0069 103	CUSHION SC(BOTTOM)		1	*	
10	00D 949 0069 006	CUSHION SC(UP)		1	*	
11	00D 104 0348 019	SP STAND (EASY)		2	*	
12	00D 461 1236 007	PORON (HH48 F10 T1)		4		
13	00D 441 2002 003	WALL MOUNTER		2		
14	00D 461 1236 007	PORON (HH48 F10 T1)		8		
15	00D 505 0367 015	ENVELOPE	for E2	1		
15	00D 505 0038 030	POLY COVER(E3/JP)	for E3, JP	1		
16	00D 511 4621 105	INST.MANUAL(302E2)	for E2	1	*	△
16	00D 511 4622 104	INST.MANUAL(302E3)	for E3	1	*	△
16	00D 511 4623 006	INST.MANUAL(302J)	for JP	1	*	
17	nsp	S.S.LIST(EX)	for E3, E2	1		△
17	00D 515 0918 607	SERVICE STATION LIST	for JP	1		
18	00D 399 1101 002	REMOCON(RC1072)		1	*	
19	nsp	POLY COVER		1		
20	nsp	POLY COVER		1		
21	nsp	BATTERY (SUM-3) ASS		1		
22	00D 203 0380 002	1P PIN CORD (VIDEO)		1		
23	00D 231 1152 001	AM LOOP ANTENNA(S)		1		
24	00D 395 0026 005	FM ANT. WIRE	for E2	1		
24	00D 395 0028 003	FM ANT ASS Y(F/WELT)	for E3, JP	1		
25	00D 461 1237 006	PORON (HH48 F6 T1)		1		
26	00D 505 0343 000	ENVELOPE		1		
27	ORD 471 3508 028	5X14 CBS-B		4		
28	00D 395 0034 000	WLAN ANNTENA		1	*	
29	00D 203 2444 001	SP CABLE ASSY(AWG22)		1		
30	00D 204 6794 006	25P D-SUB CABLE		1		
31	00D 511 4624 005	SETUP GUIDE		1	*	
★ 32	nsp	WARRANTY (HOME)	for E3	1		
★ 33	00D 517 1505 028	UPC LABEL	for E3	1	*	
★ 33	nsp	E2 POS LABEL	for E2	2	*	
★ 33	00D 517 1506 014	POS LABEL	for JP	1	*	
★ 34	00D 513 3880 008	DATE LABEL	for JP	1		
★ 35	nsp	CONT.CARD(L)SUB ASSY	for E3, E2	1		
★ 36	nsp	GUARANTEE(S)SUB ASSY	for JP	1		



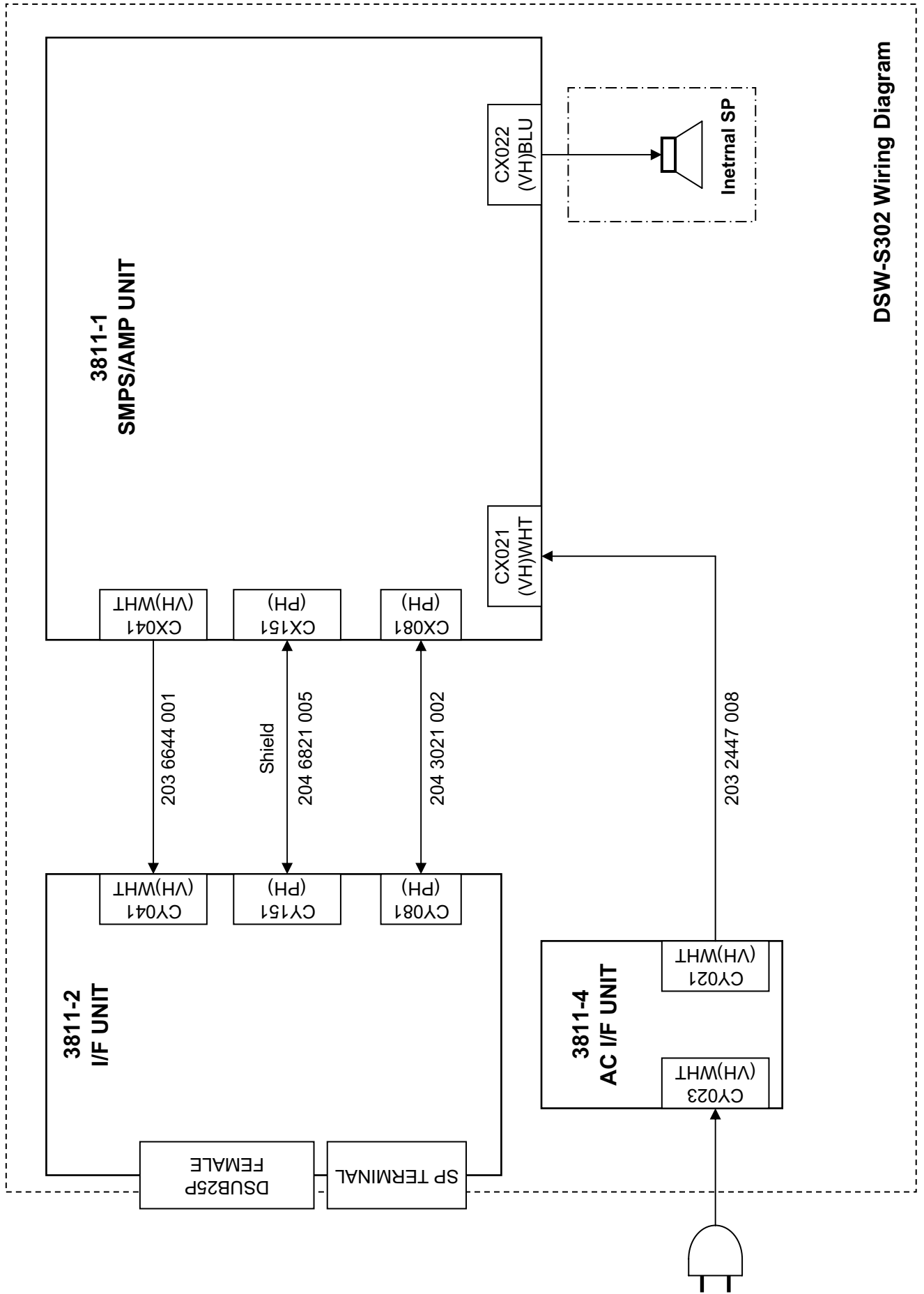

DSW-S302 Wiring Diagram

## MEASURING METHOD AND WAVEFORMS

To check the waveforms on the FEP, the GND (-) probe of the oscilloscope to "VHALF" point.  
(Except for Inner SW, TRVSW)

### NOTES

Measuring Disc: DVD/VT502 or TDV-520A  
CD/TCD-784

(It is better to use wires for extending between the probe and test points.)

- When watching the HF waveform, use the extending wire as short as possible.
- When HF waveform is noisy or cannot discriminate the eye-pattern, replace the Traverse Unit after measuring the lop.
- ① ~ ⑬ points have the certain test points shown below.

## 各部の波形と測定方法

FEP 基板の波形チェックを行うためにはオシロスコープの GND(-) プローブを "VHALF" ポイントに接続します。

### 注意

測定ディスク： DVD/VT502 or TDV-520A  
CD/TCD-784

(テストポイントとプローブ間に延長ワイヤを使用するのがより良い方法です。)

- HF 波形を観測する場合、できるだけ短い延長ワイヤを使用してください。
- HF 波形がノイズで不明瞭、またはアイパターンが識別不能の場合は lop 測定後にトラバースユニットを交換してください。
- ポイント①～⑬は、下図のように特定テストポイント付きです。

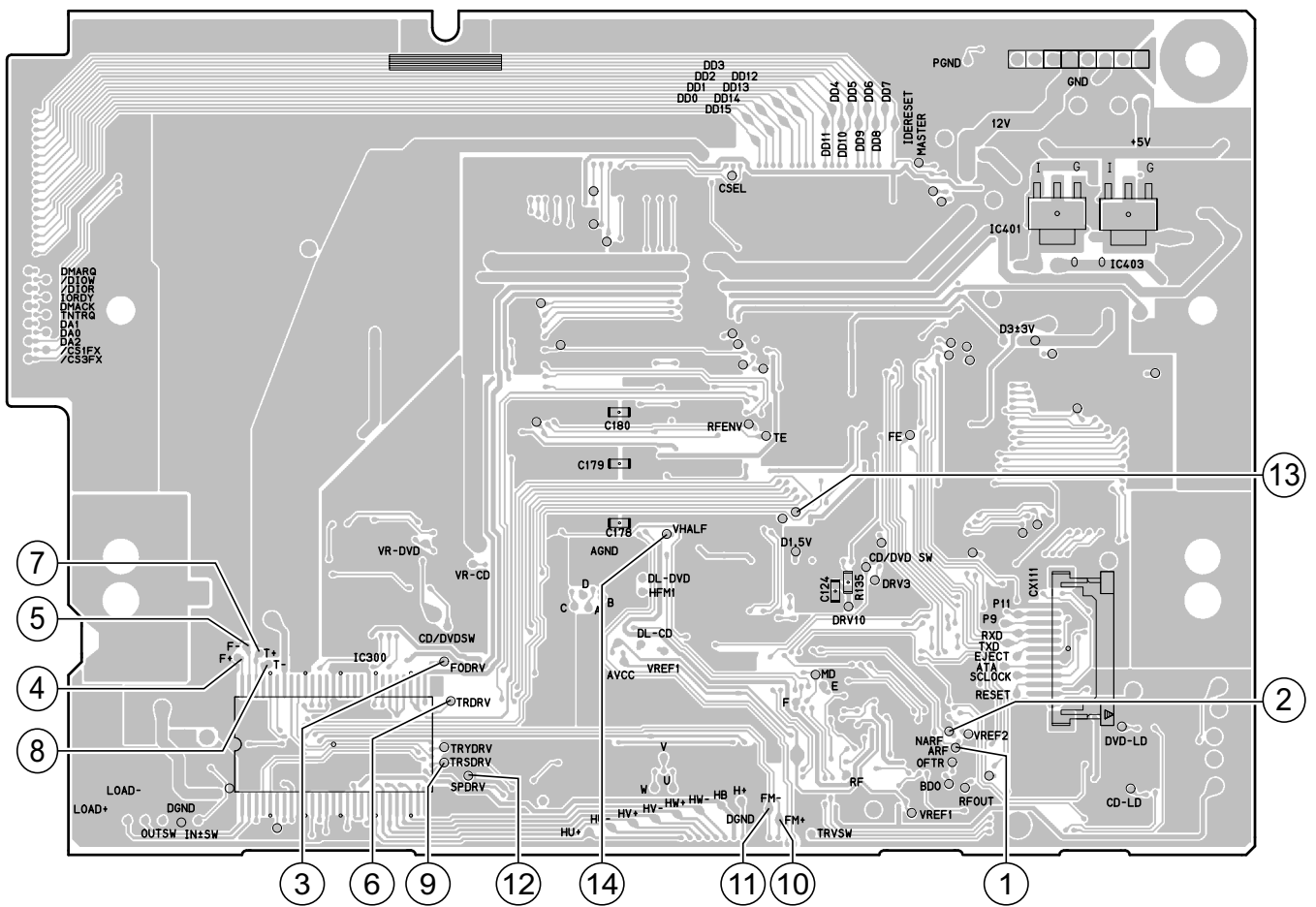

IU-3807 FEP Unit : Foil Side

\* For ARF ①, use NARF ② as the reference (probe ⊖) for the oscilloscope, VHALF ⑭ as the reference voltage for other points.

\* ARF ①は NARF ②をオシロスコープの基準 (プローブ⊖) とし、他のポイントの基準電圧は VHALF ⑭です。

# WAVEFORMS

## IU-3807 FEP Unit.

DVD PLAY Disc : TDV-520A

RF waveform

- ① ARF
- ② NARF

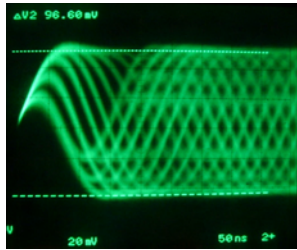

RANGE ① .2 v     ② .05 μsec

DVD LOADING → PLAY

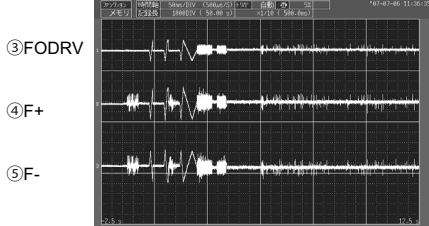

RANGE ③ .5 v  
④ .5 v     0.5 sec  
⑤ .5 v

DVD PLAY

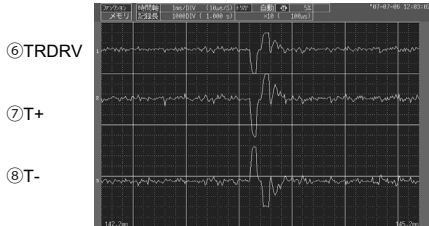

RANGE ⑥ .2 v  
⑦ .2 v     100 μsec  
⑧ .2 v

SEARCH (INNER → OUTER)



RANGE ⑨ 1 v  
⑩ 1 v     50 msec  
⑪ 1 v

DVD PLAY (INNER)

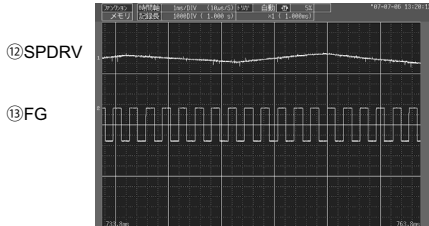

RANGE ⑫ .1 v  
⑬ 1 v     1 msec

CD PLAY Disc : TCD-784

RF waveform

- ① ARF
- ② NARF

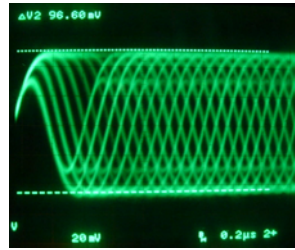

RANGE ① .2 v     ② .2 μsec

CD LOADING → PLAY

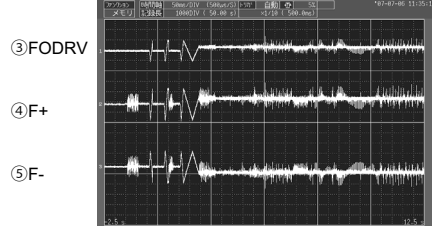

RANGE ③ .5 v  
④ .5 v     0.5 sec  
⑤ .5 v

CD PLAY



RANGE ⑥ .2 v  
⑦ .2 v     100 μsec  
⑧ .2 v

SEARCH (INNER → OUTER)

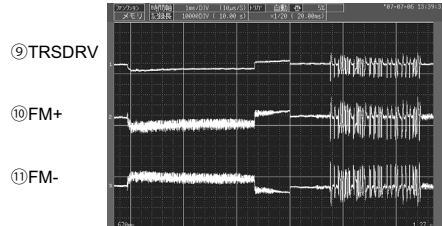

RANGE ⑨ 1 v  
⑩ 1 v     20 msec  
⑪ 1 v

CD PLAY (INNER)

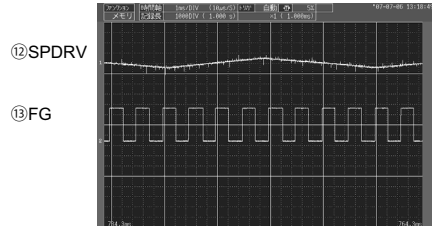

RANGE ⑫ .1 v  
⑬ 1 v     1 msec

## NOTE FOR SCHEMATIC DIAGRAM

### WARNING:

Parts marked with this symbol  $\triangle$  have critical characteristics. Use ONLY replacement parts recommended by the manufacturer.

### CAUTION:

Before returning the unit to the customer, make sure you make either (1) a leakage current check or (2) a line to chassis resistance check. If the leakage current exceeds 0.5 milliamps, or if the resistance from chassis to either side of the power cord is less than 460 kohms, the unit is defective.

### WARNING:

DO NOT return the unit to the customer until the problem is located and corrected.

### NOTICE:

ALL RESISTANCE VALUES IN OHM. k=1,000 OHM  
M=1,000,000 OHM  
ALL CAPACITANCE VALUES IN MICRO FARAD.  
P=MICRO-MICRO FARAD  
EACH VOLTAGE AND CURRENT ARE MEASURED AT  
NO SIGNAL INPUT CONDITION.  
CIRCUIT AND PARTS ARE SUBJECT TO CHANGE  
WITHOUT PRIOR NOTICE.

## 配線図について

$\triangle$ 印の部品は安全を維持するために重要な部品です。従って交換時は必ず指定の部品を使用してください。

### 注)

- (1) 指定なき抵抗値は  $\Omega$ 、k は k  $\Omega$ 、M は M  $\Omega$  を示す。
- (2) 指定なきコンデンサーの値は  $\mu\text{F}$ 、p は pF を示す。
- (3) 各部の電圧は無信号の値を示す。
- (4) この配線図は基本配線図です。改良等のため変更することがありますのでご了承ください。

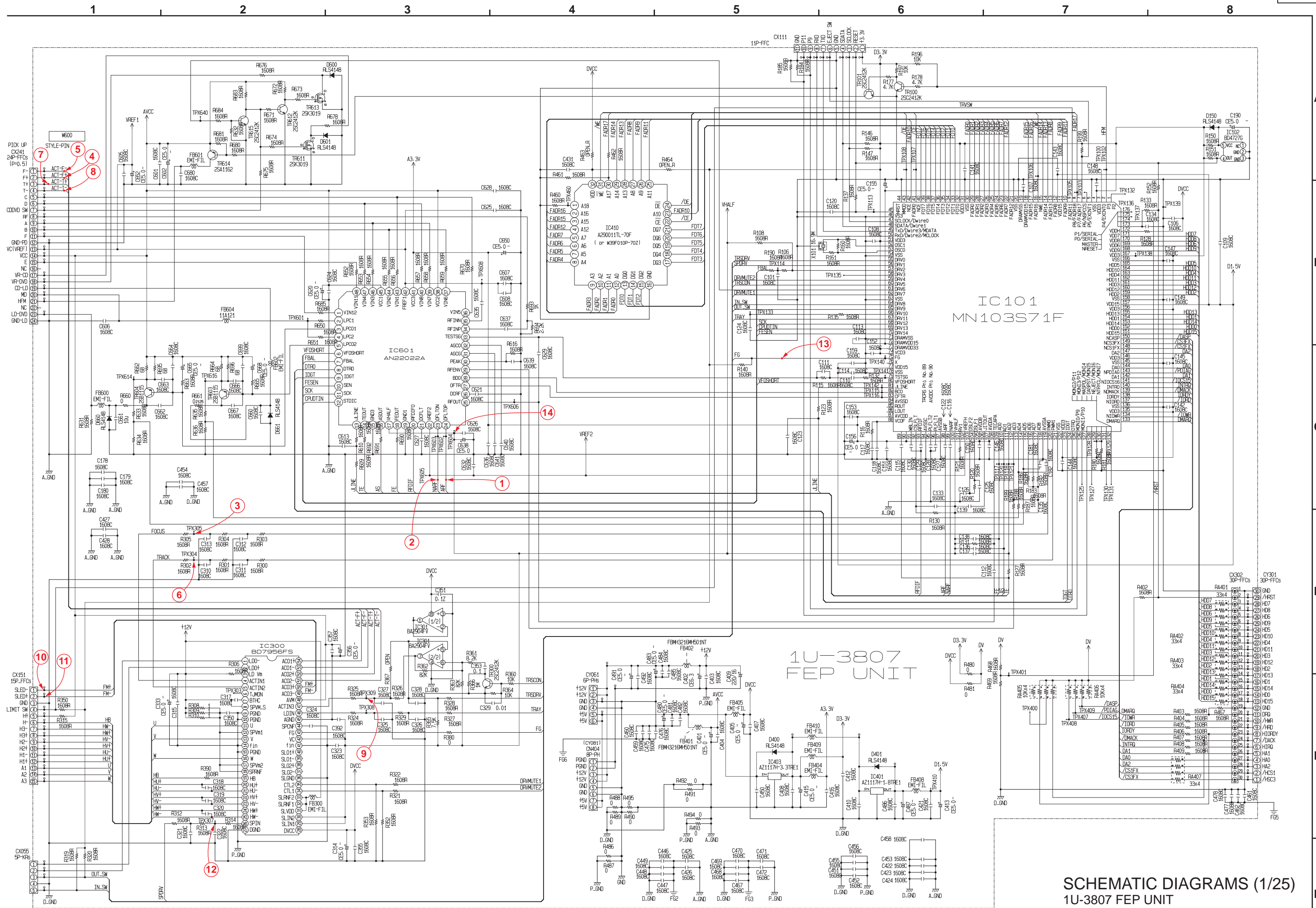

SCHEMATIC DIAGRAMS (1/25)  
1U-3807 FEP UNIT



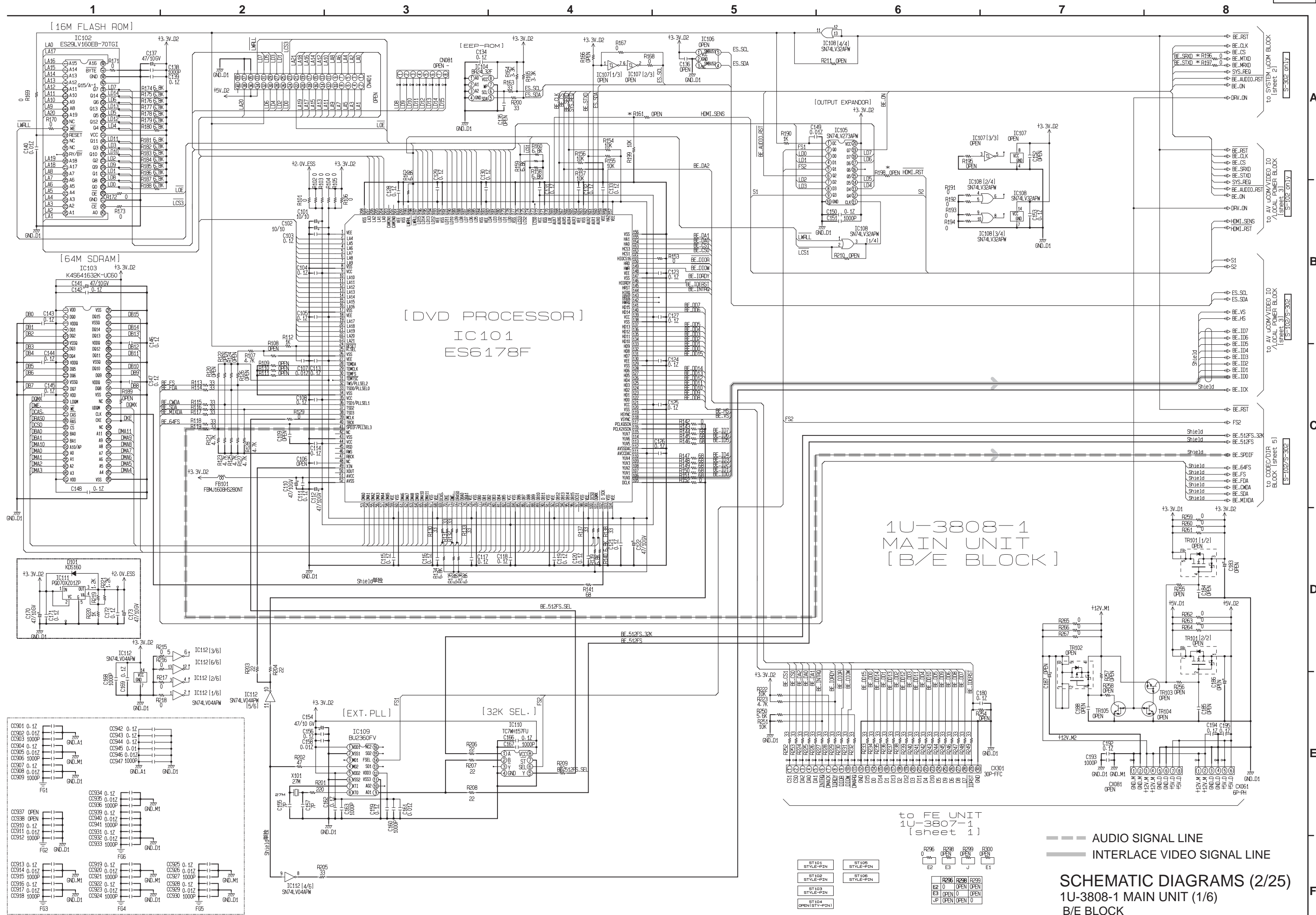

--- AUDIO SIGNAL LINE  
 — INTERLACE VIDEO SIGNAL LINE

SCHMATIC DIAGRAMS (2/25)  
 1U-3808-1 MAIN UNIT (1/6)  
 B/E BLOCK

ST101	STYLE-PIN	ST108	STYLE-PIN
ST102	STYLE-PIN	ST109	STYLE-PIN
ST103	STYLE-PIN	ST110	STYLE-PIN
ST104	OPEN(STY-PIN)		

R296	R298	R299	R300
E2 0	E3 0	J	E1
E3 0	OPEN	OPEN	OPEN
UP	OPEN	OPEN	0







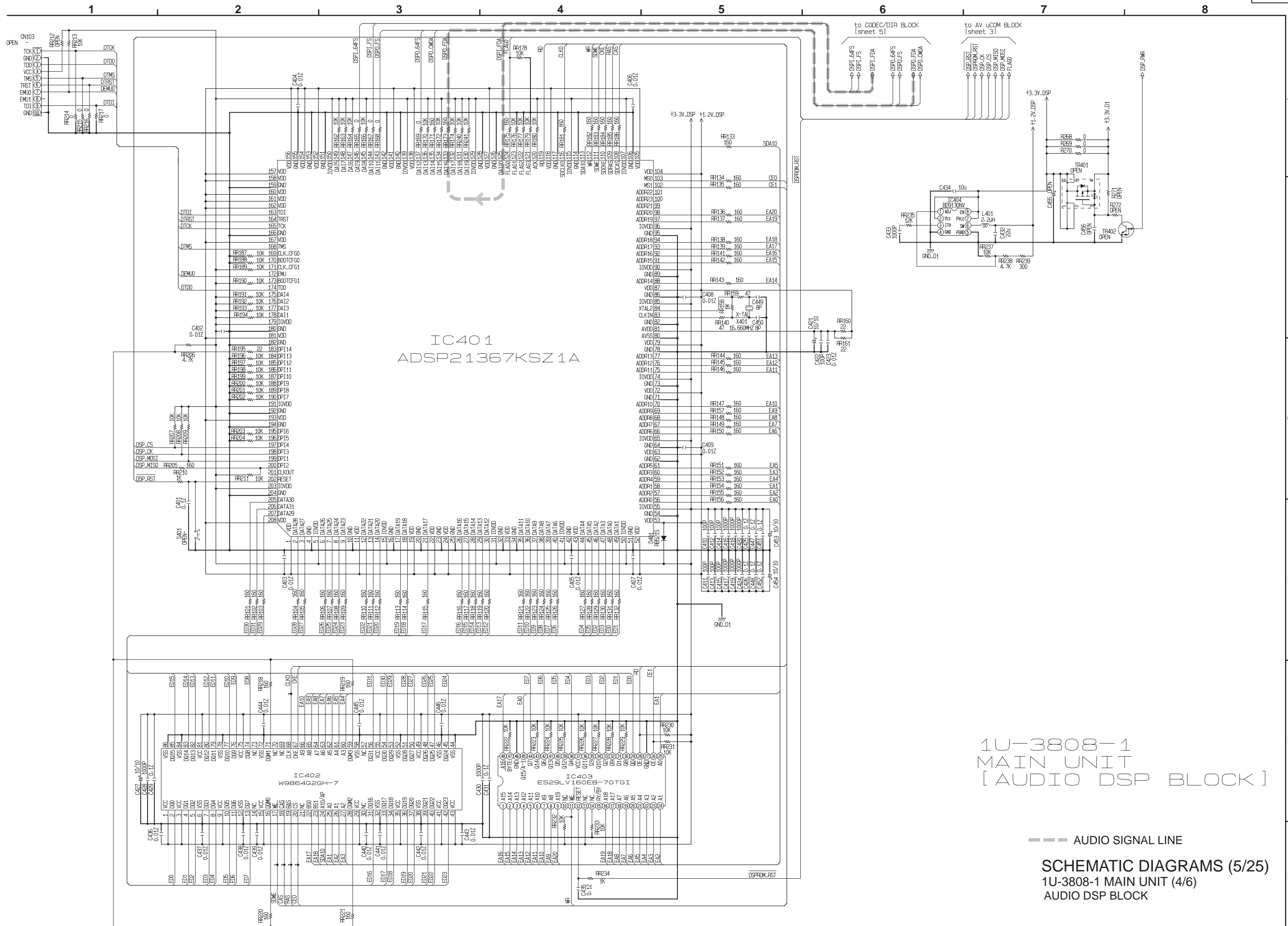

1U-3808-1  
MAIN UNIT  
[AUDIO DSP BLOCK]

--- AUDIO SIGNAL LINE

SCHMATIC DIAGRAMS (5/25)  
1U-3808-1 MAIN UNIT (4/6)  
AUDIO DSP BLOCK

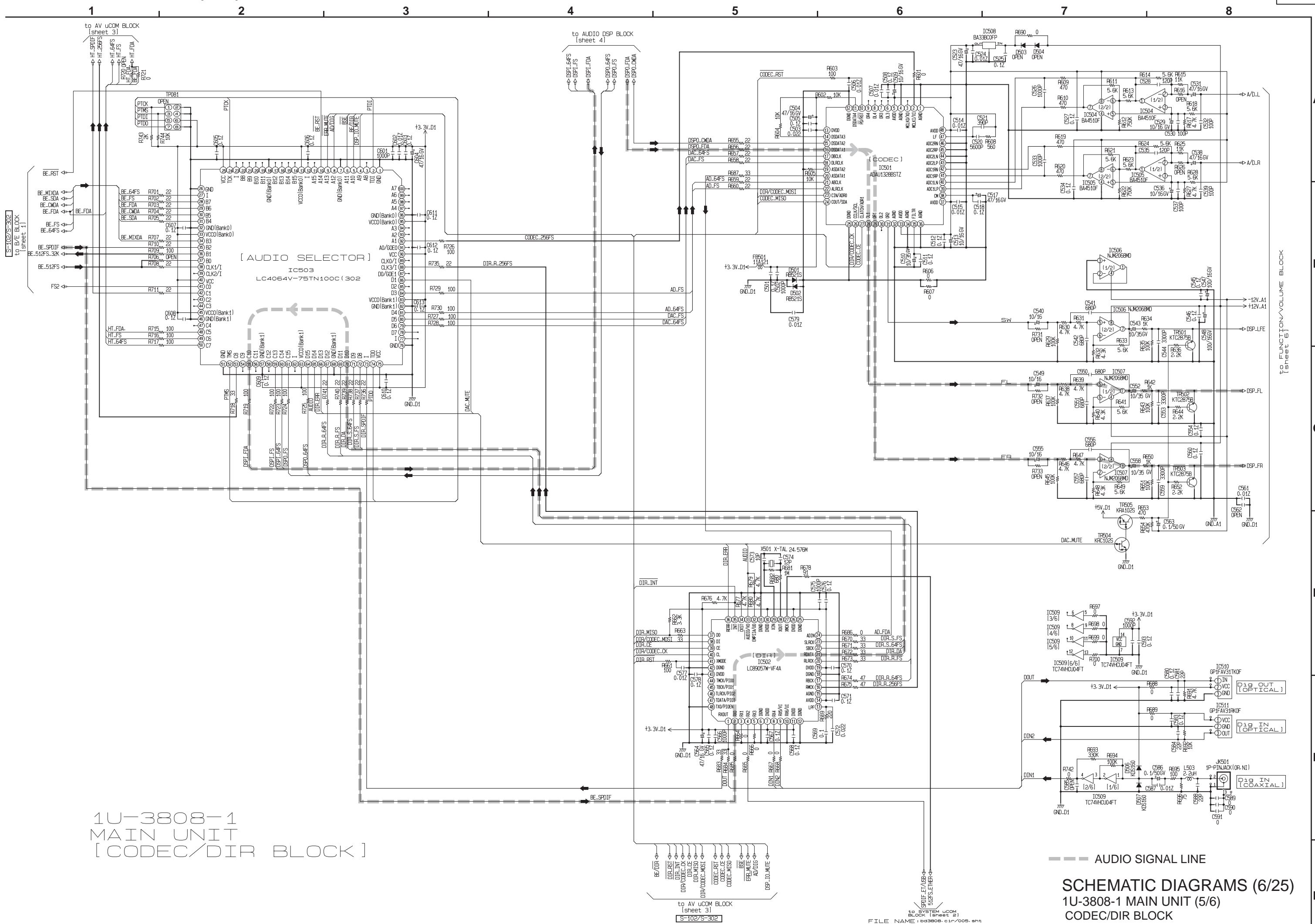

1U-3808-1  
MAIN UNIT  
[CODEC/DIR BLOCK]

--- AUDIO SIGNAL LINE

SCHEMATIC DIAGRAMS (6/25)  
1U-3808-1 MAIN UNIT (5/6)  
CODEC/DIR BLOCK



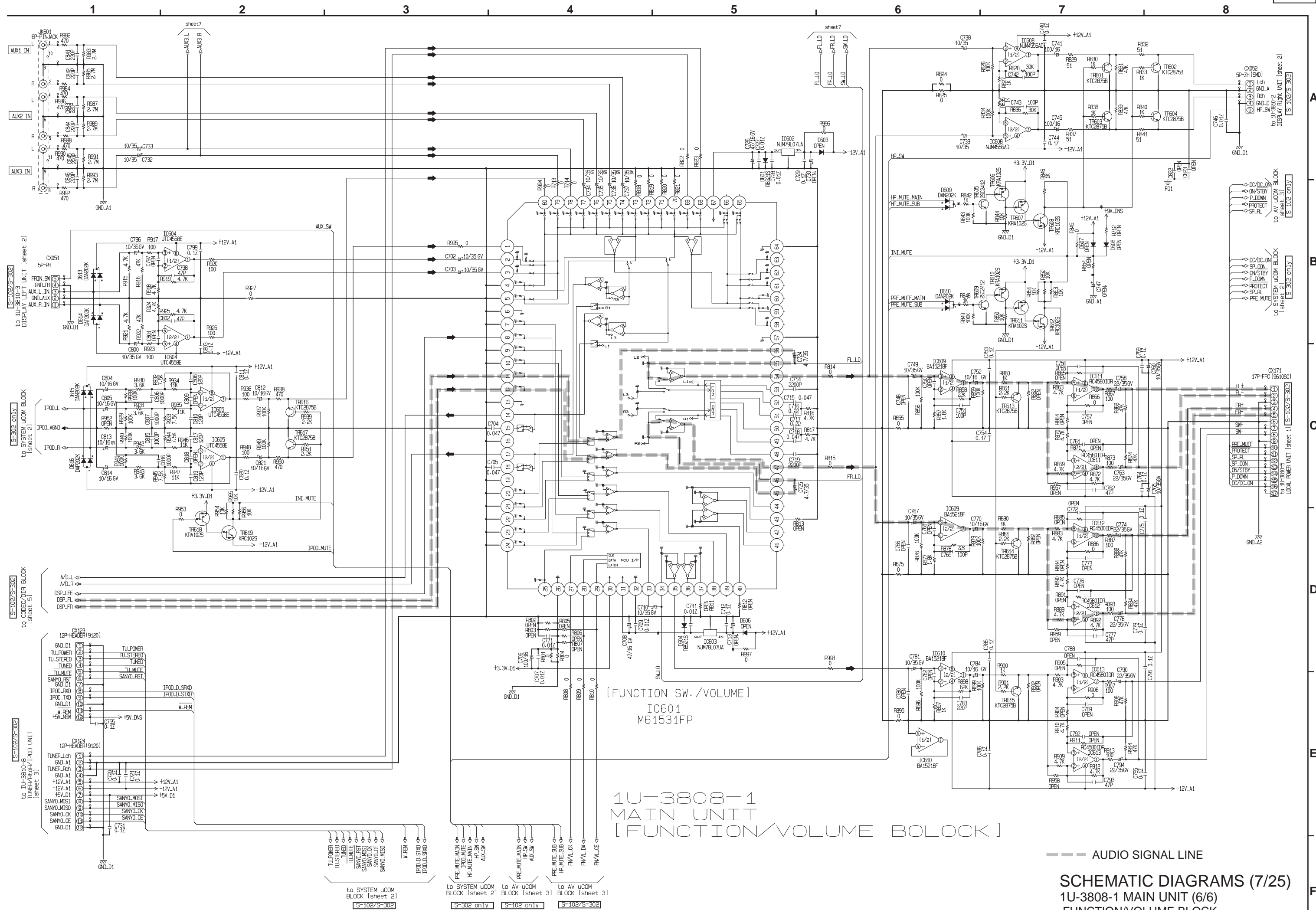

IC601  
M61531FP

1U-3808-1  
MAIN UNIT  
[FUNCTION/VOLUME BLOCK]

--- AUDIO SIGNAL LINE

SCHMATIC DIAGRAMS (7/25)  
1U-3808-1 MAIN UNIT (6/6)  
FUNCTION/VOLUME BLOCK

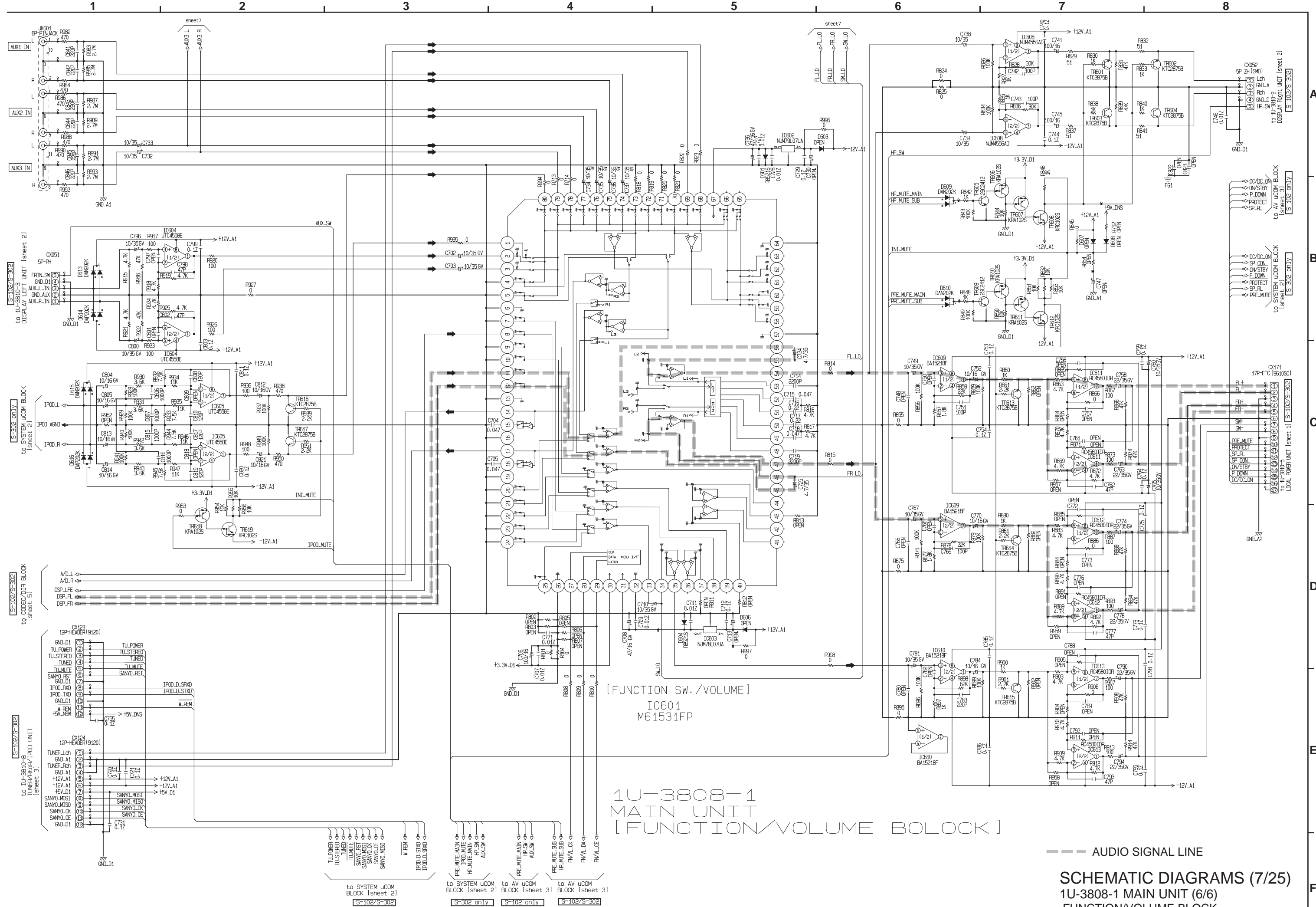
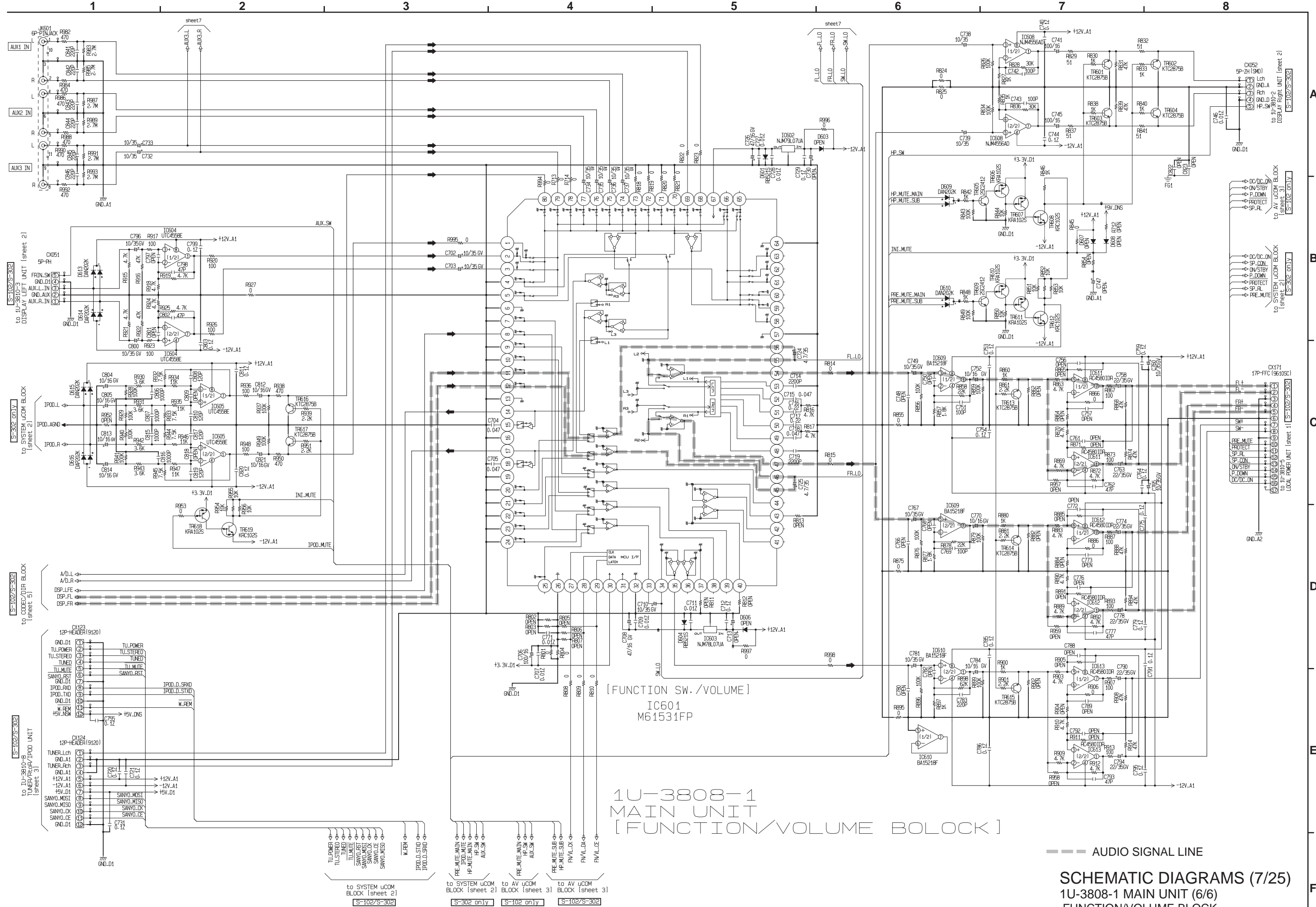









1U-3809-1  
VIDEO UNIT  
[ I/P & SCALER BLOCK ]

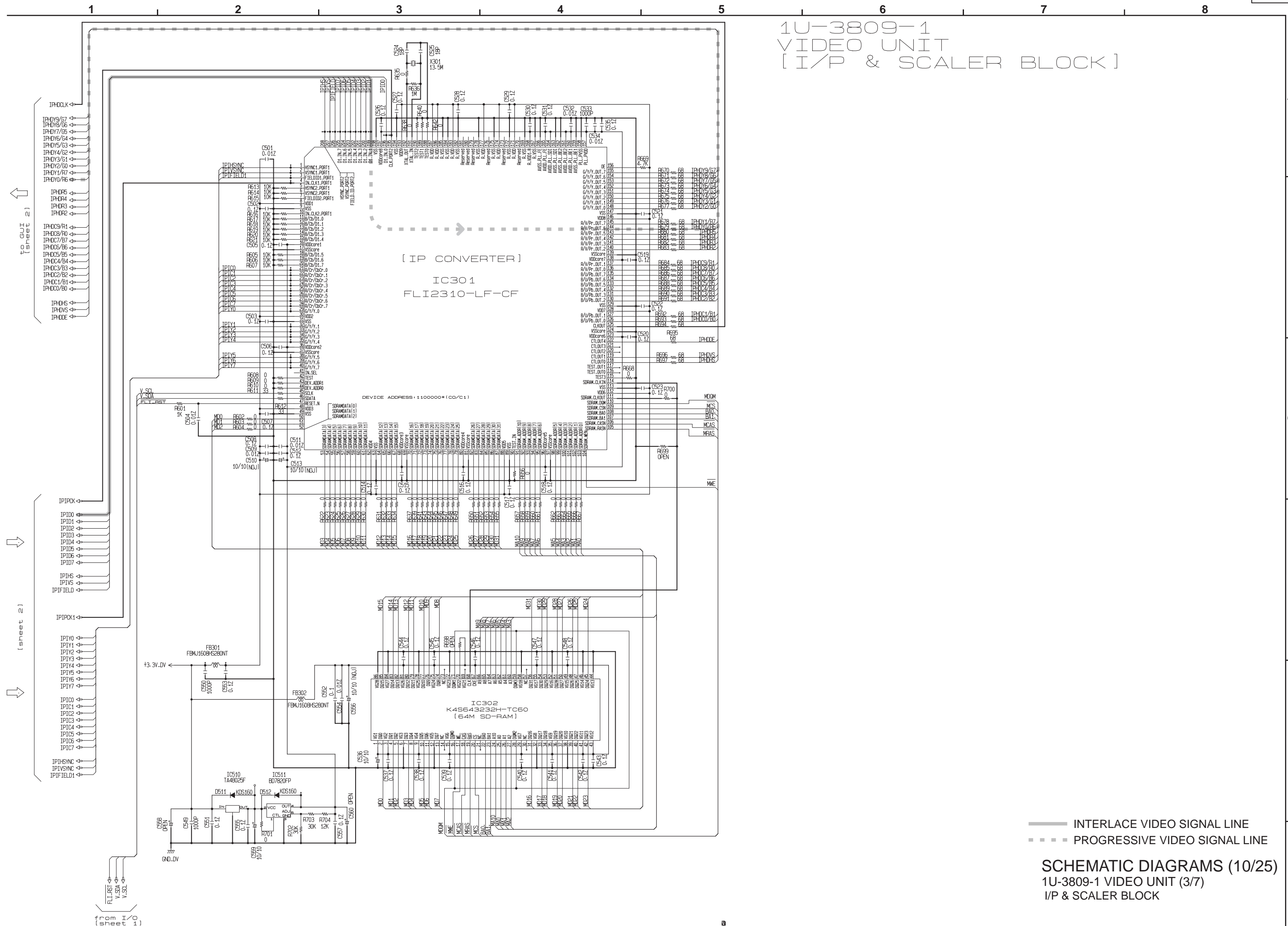

— INTERLACE VIDEO SIGNAL LINE  
 - - - PROGRESSIVE VIDEO SIGNAL LINE

SCHEMATIC DIAGRAMS (10/25)  
 1U-3809-1 VIDEO UNIT (3/7)  
 I/P & SCALER BLOCK

(sheet 2)

(sheet 2)

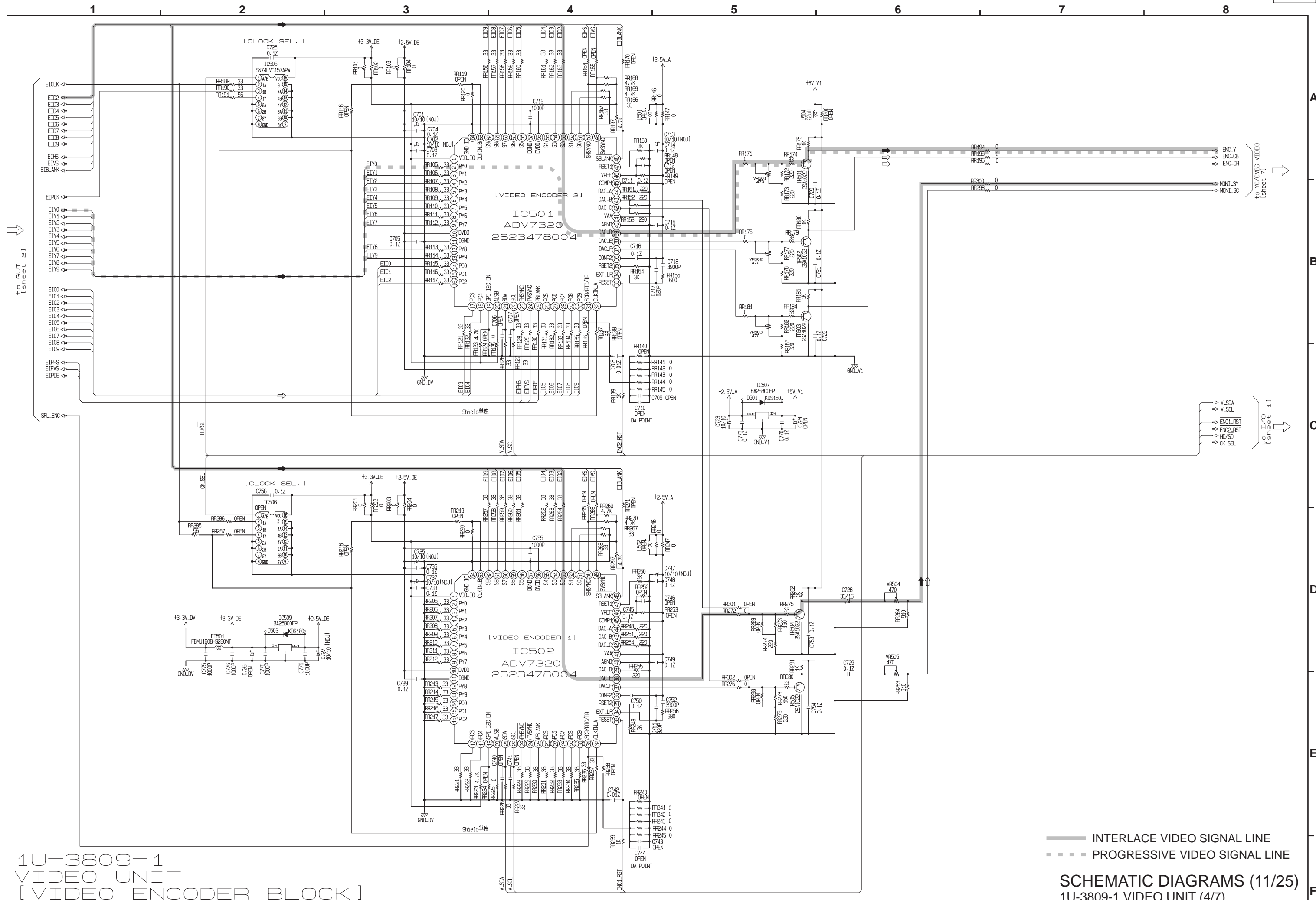

1U-3809-1  
VIDEO UNIT  
[ VIDEO ENCODER BLOCK ]

— INTERLACE VIDEO SIGNAL LINE  
- - - PROGRESSIVE VIDEO SIGNAL LINE

SCHEMATIC DIAGRAMS (11/25)  
1U-3809-1 VIDEO UNIT (4/7)  
VIDEO ENCODER BLOCK

1U-3809-1  
VIDEO UNIT  
[ COMPONENT VIDEO BLOCK ]

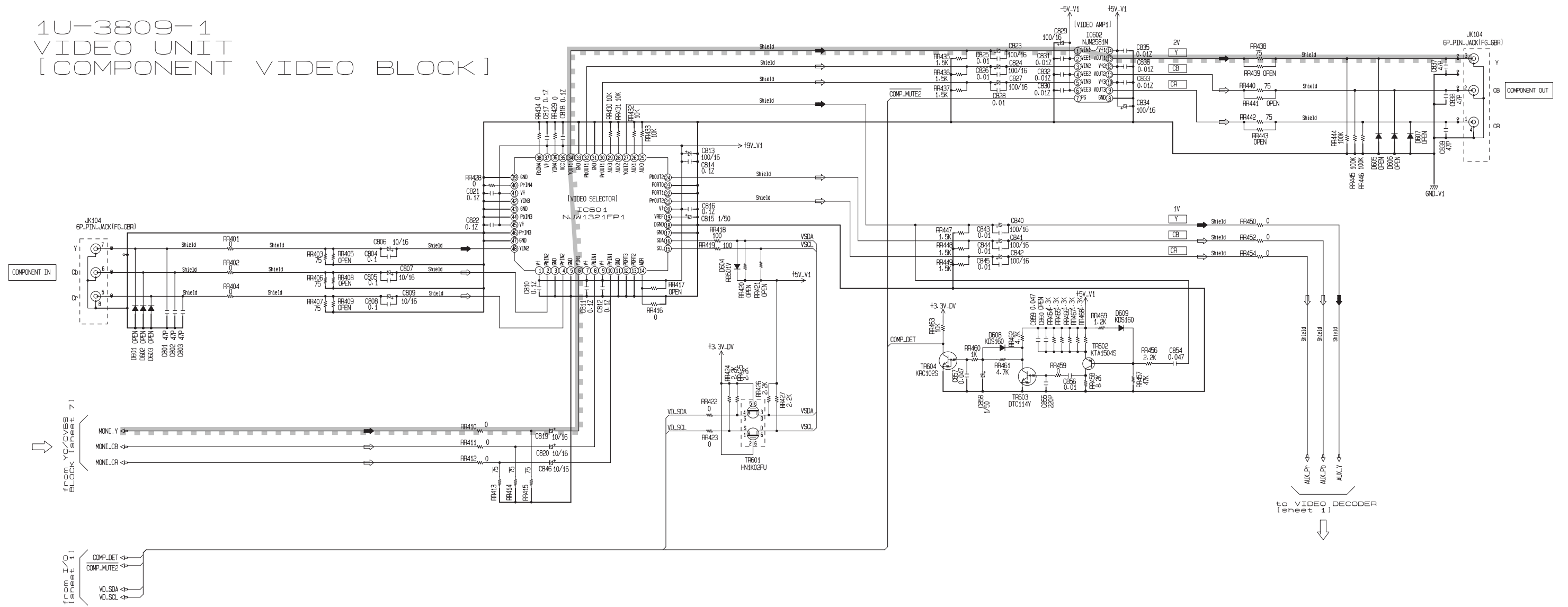

- INTERLACE VIDEO SIGNAL LINE
- - - PROGRESSIVE VIDEO SIGNAL LINE

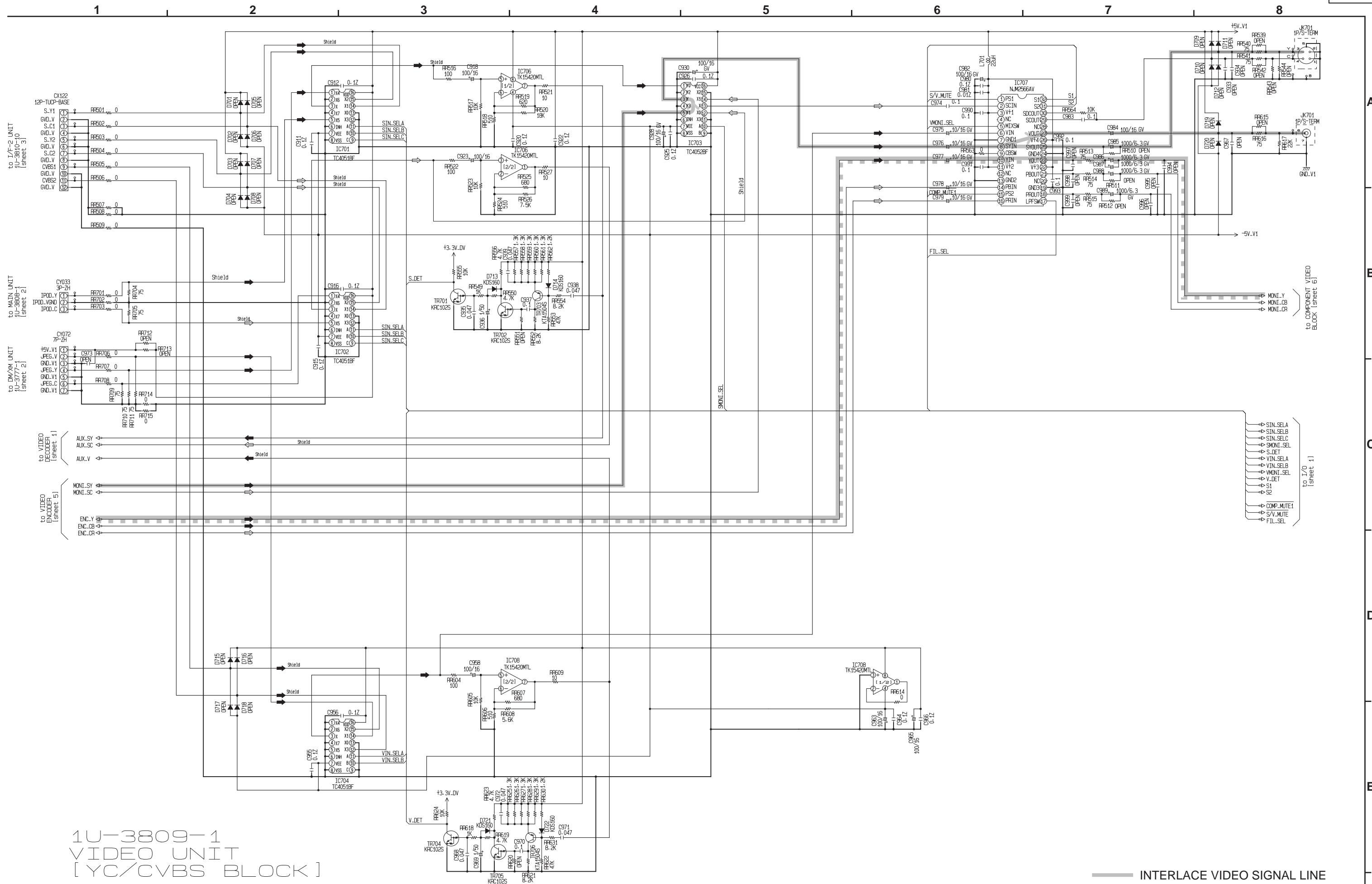

1U-3809-1  
VIDEO UNIT  
[YC/CVBS BLOCK]

— INTERLACE VIDEO SIGNAL LINE  
- - - PROGRESSIVE VIDEO SIGNAL LINE

SCHEMATIC DIAGRAMS (13/25)  
1U-3809-1 VIDEO UNIT (6/7)  
YC/CVBS BLOCK

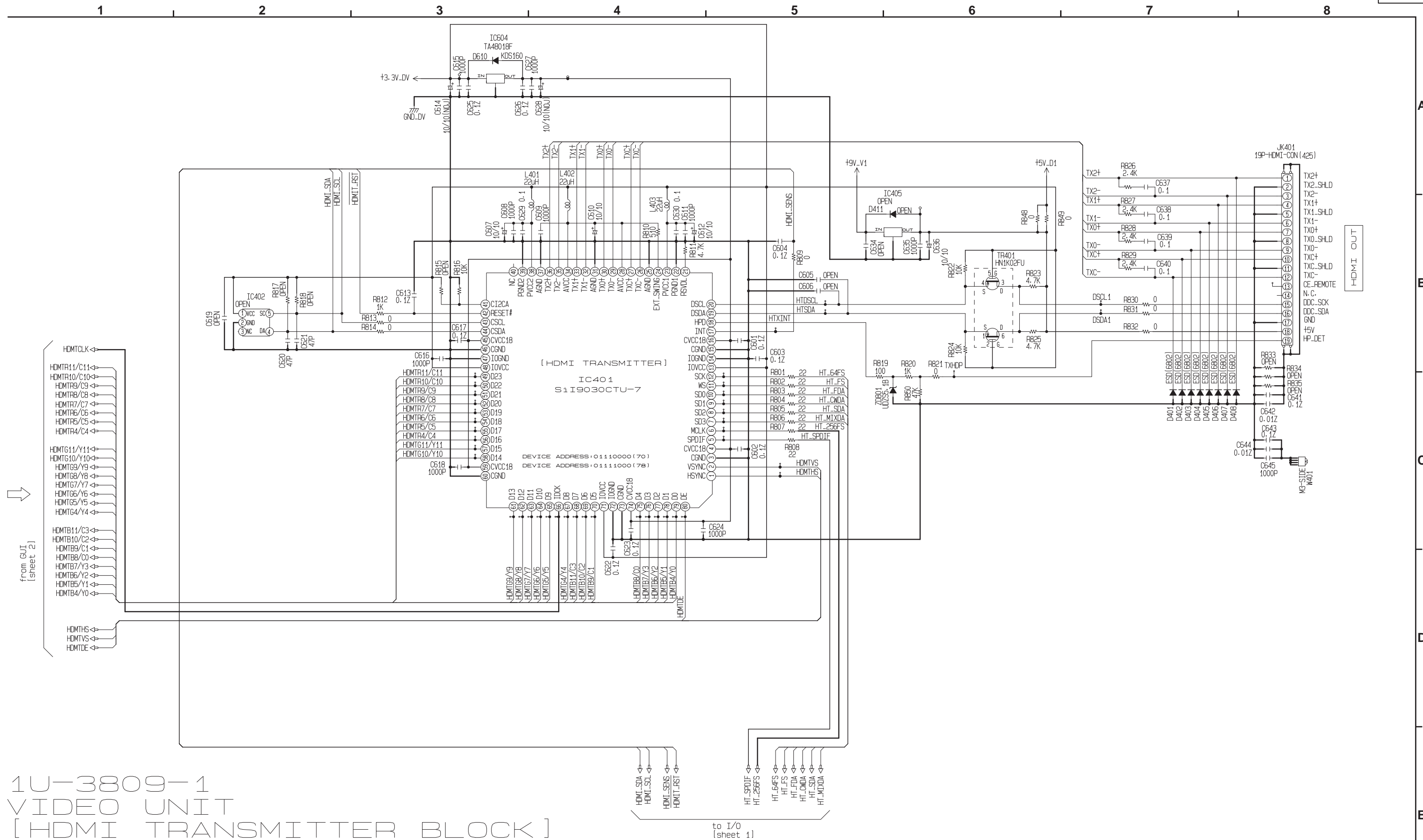

1U-3809-1  
 VIDEO UNIT  
 [HDMI TRANSMITTER BLOCK]





1 2 3 4 5 6 7 8

to 1U-3772  
AV UNIT  
to 1U-3809-1  
VIDEO UNIT

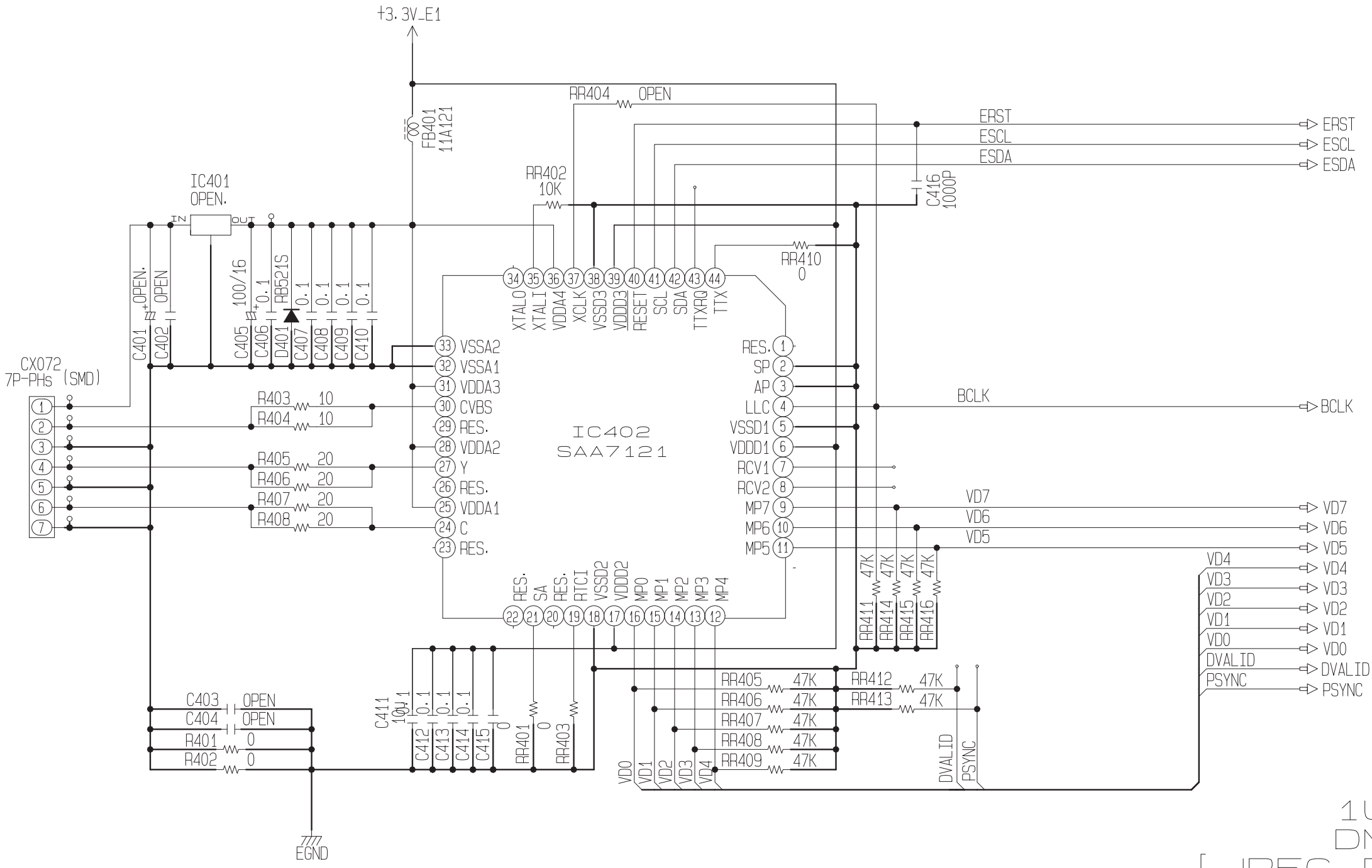

1U-3777-1  
DM/XM UNIT  
[ JPEG DECODER BLOCK ]

1 2 3 4 5 6 7 8

1U-3810-5  
LOCAL POWER UNIT

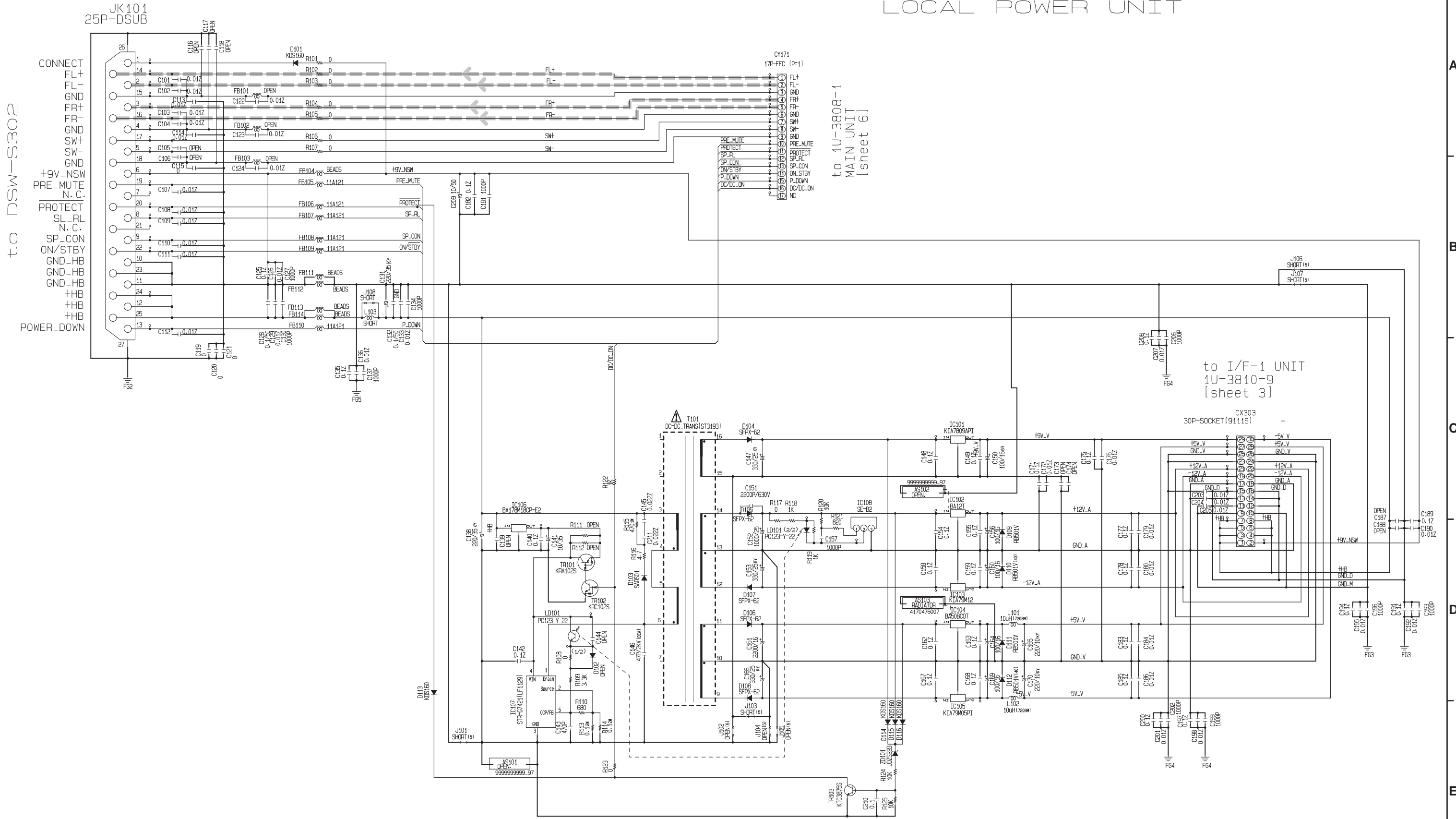

to DSW-S302

to 1U-3808-1  
MAIN UNIT  
(sheet 6)

to I/F-1 UNIT  
1U-3810-9  
(sheet 3)

--- AUDIO SIGNAL LINE

A  
B  
C  
D  
E



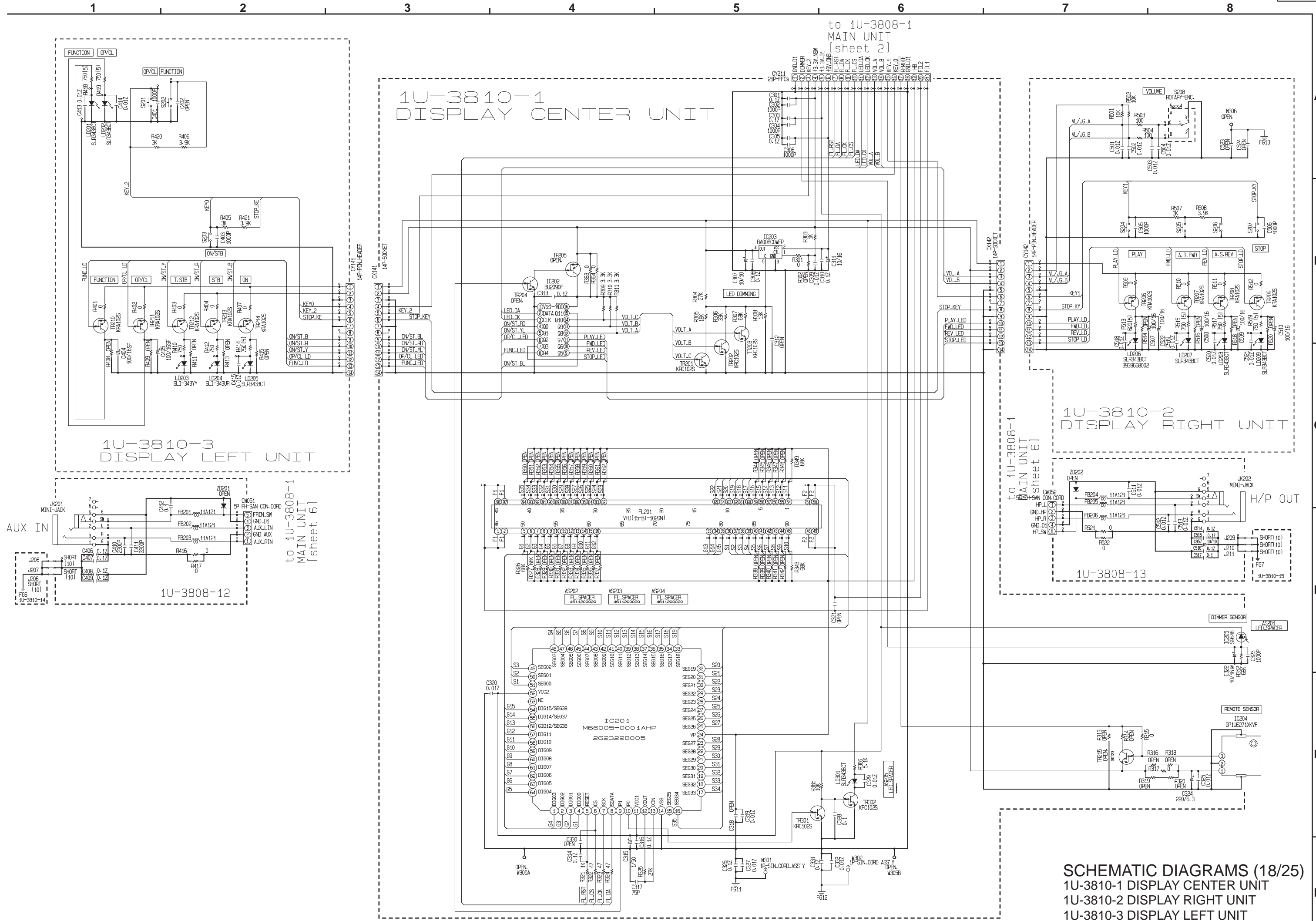

SCHMATIC DIAGRAMS (18/25)  
 1U-3810-1 DISPLAY CENTER UNIT  
 1U-3810-2 DISPLAY RIGHT UNIT  
 1U-3810-3 DISPLAY LEFT UNIT  
 1U-3808-12 AUX IN UNIT  
 1U-3808-13 H/P OUT UNIT



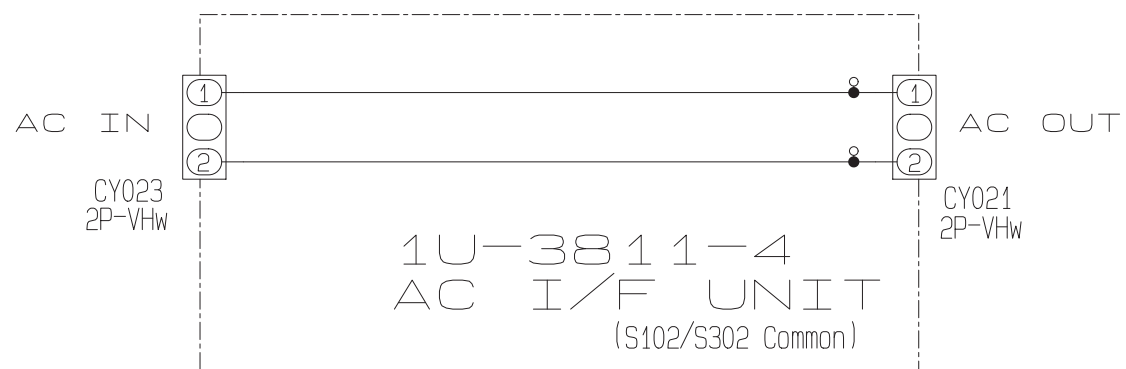
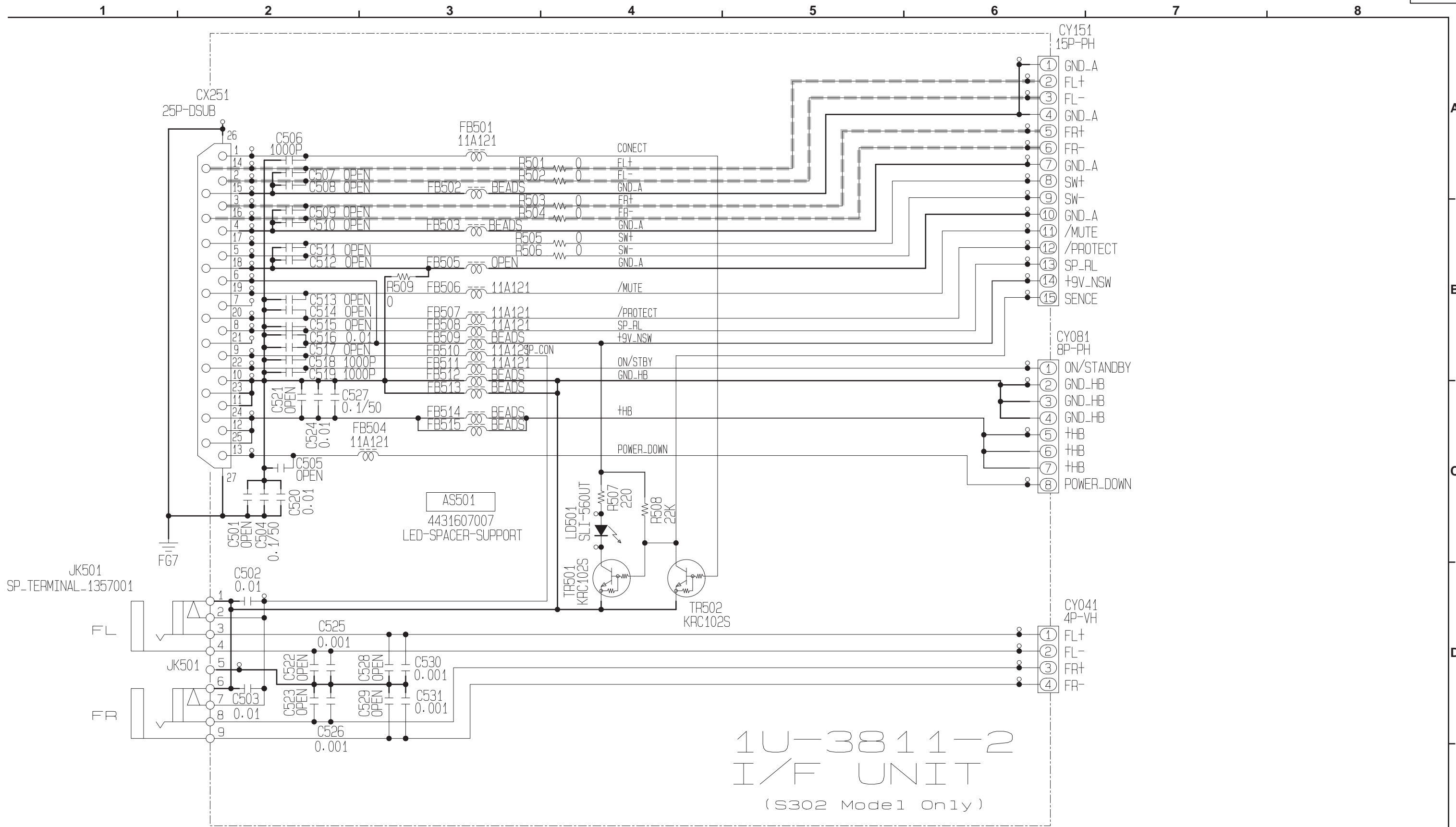

--- AUDIO SIGNAL LINE

**SCHMATIC DIAGRAMS (20/25)**

1U-3811-2 I/F UNIT  
1U-3811-4 AC I/F UNIT

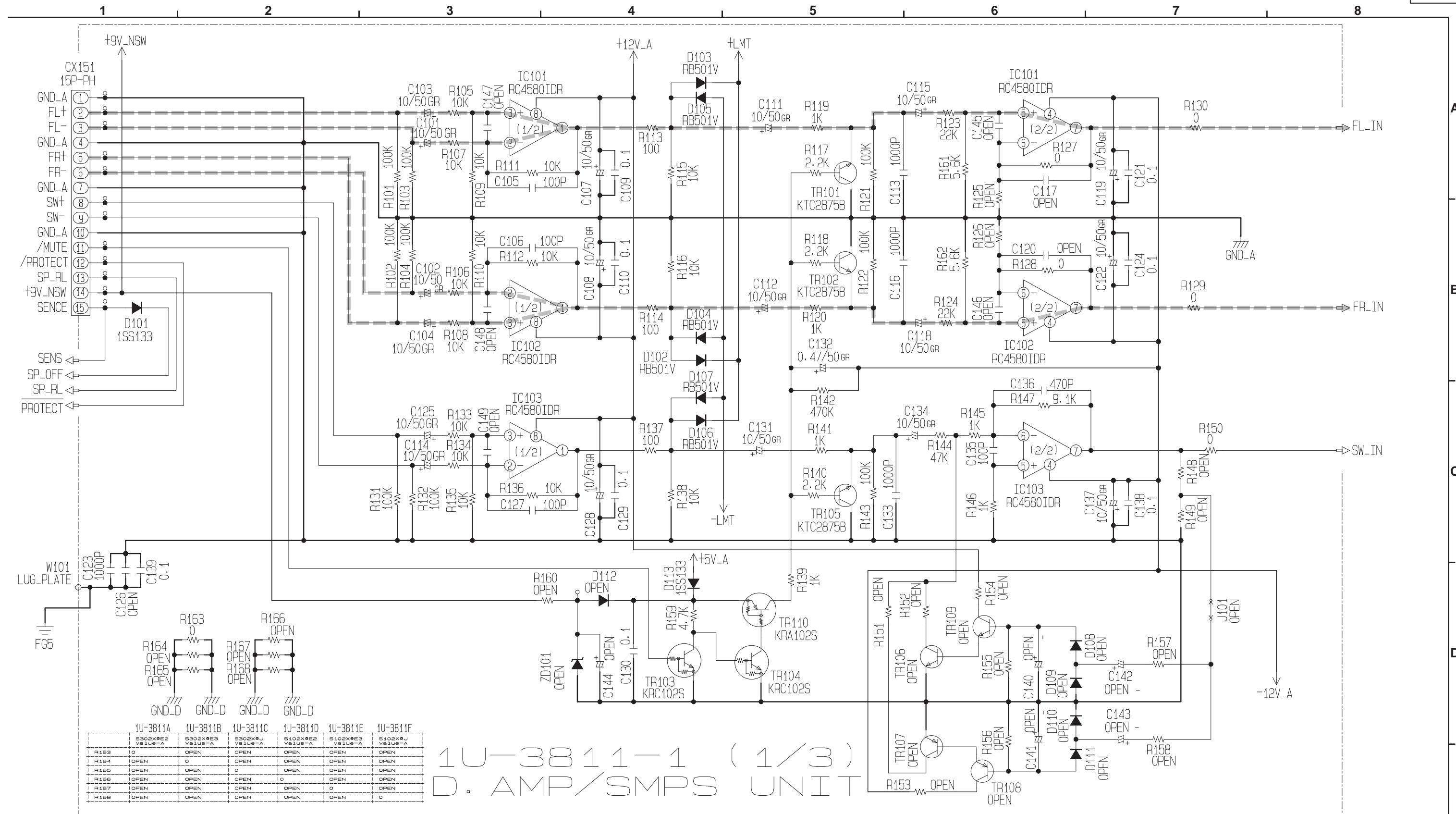

1U-3811-1 (1/3)  
D. AMP/SMPS UNIT

--- AUDIO SIGNAL LINE



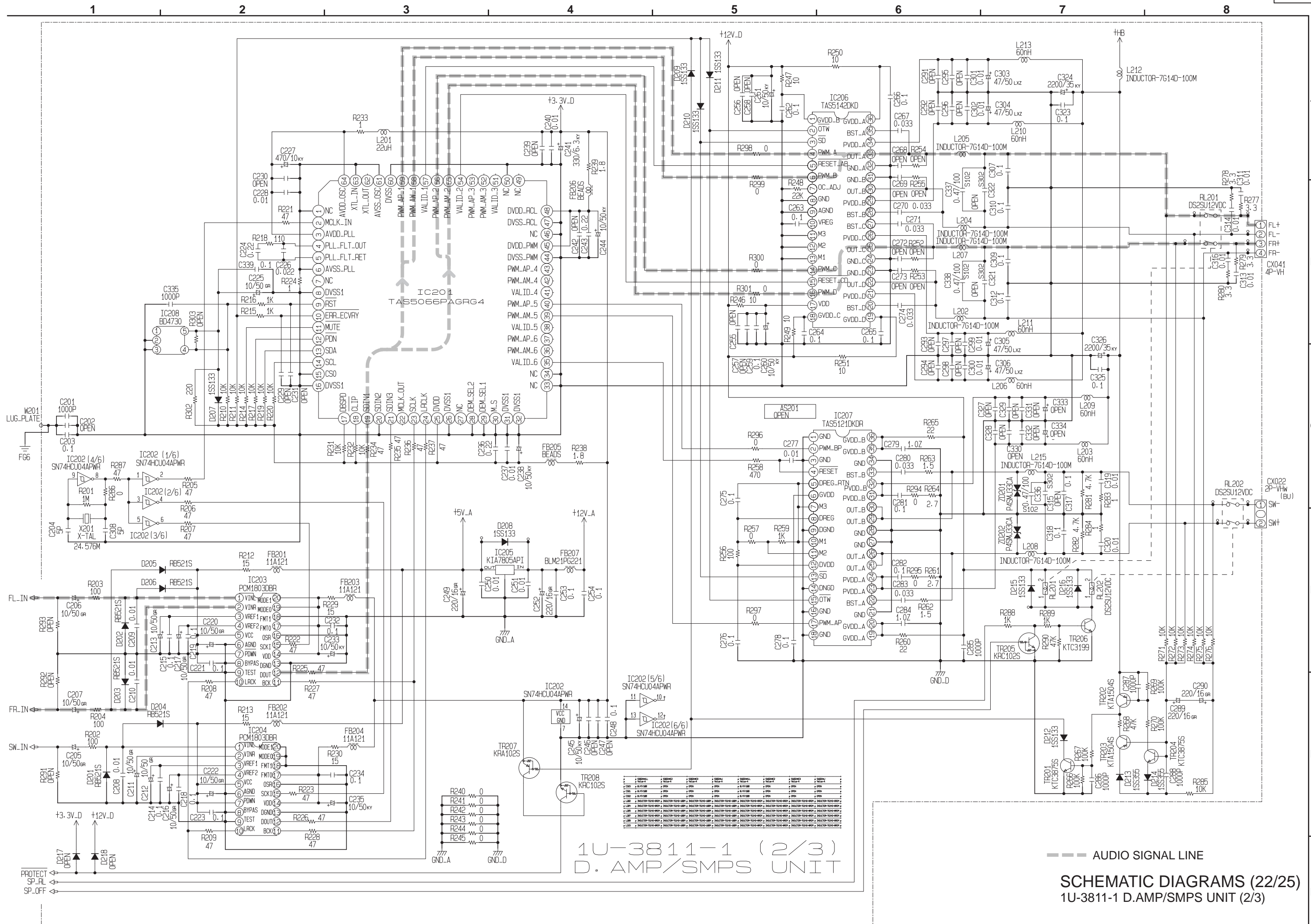

1U-3811-1 (2/3)  
D. AMP/SMPS UNIT

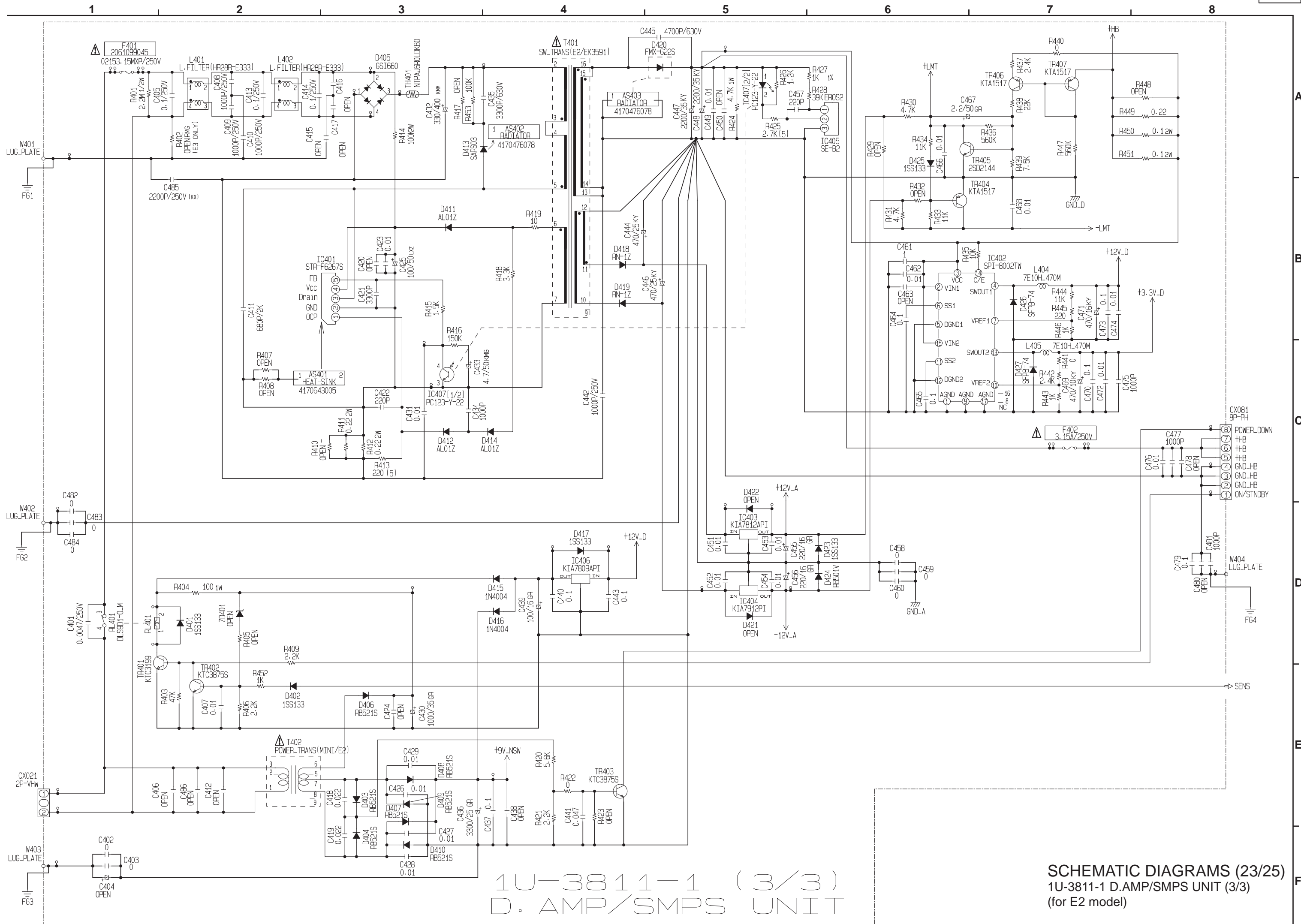

1U-3811-1 (3/3)  
D. AMP/SMPS UNIT

SCHEMATIC DIAGRAMS (23/25)  
1U-3811-1 D. AMP/SMPS UNIT (3/3)  
(for E2 model)

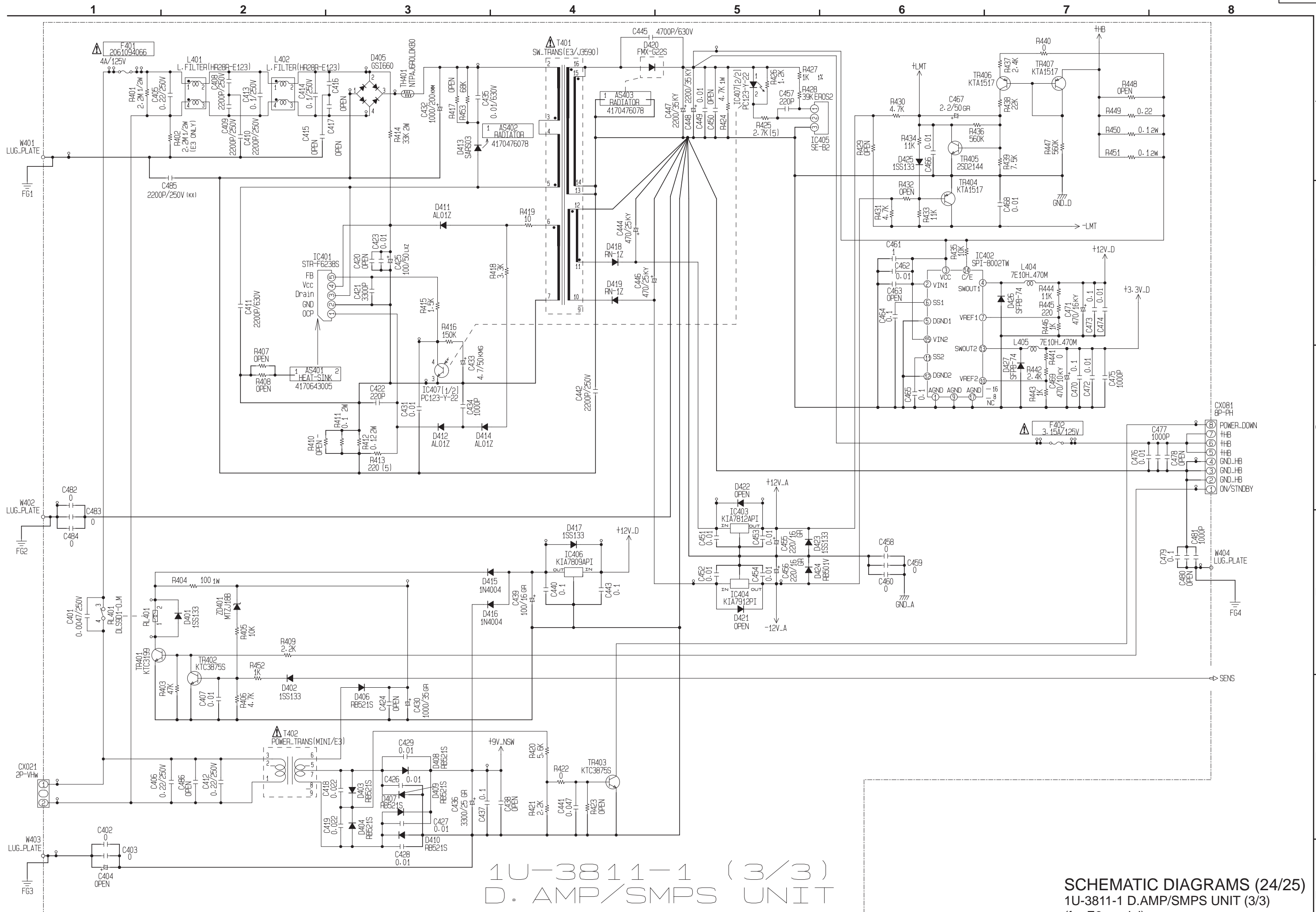

1U-3811-1 (3/3)  
 D. AMP/SMPS UNIT

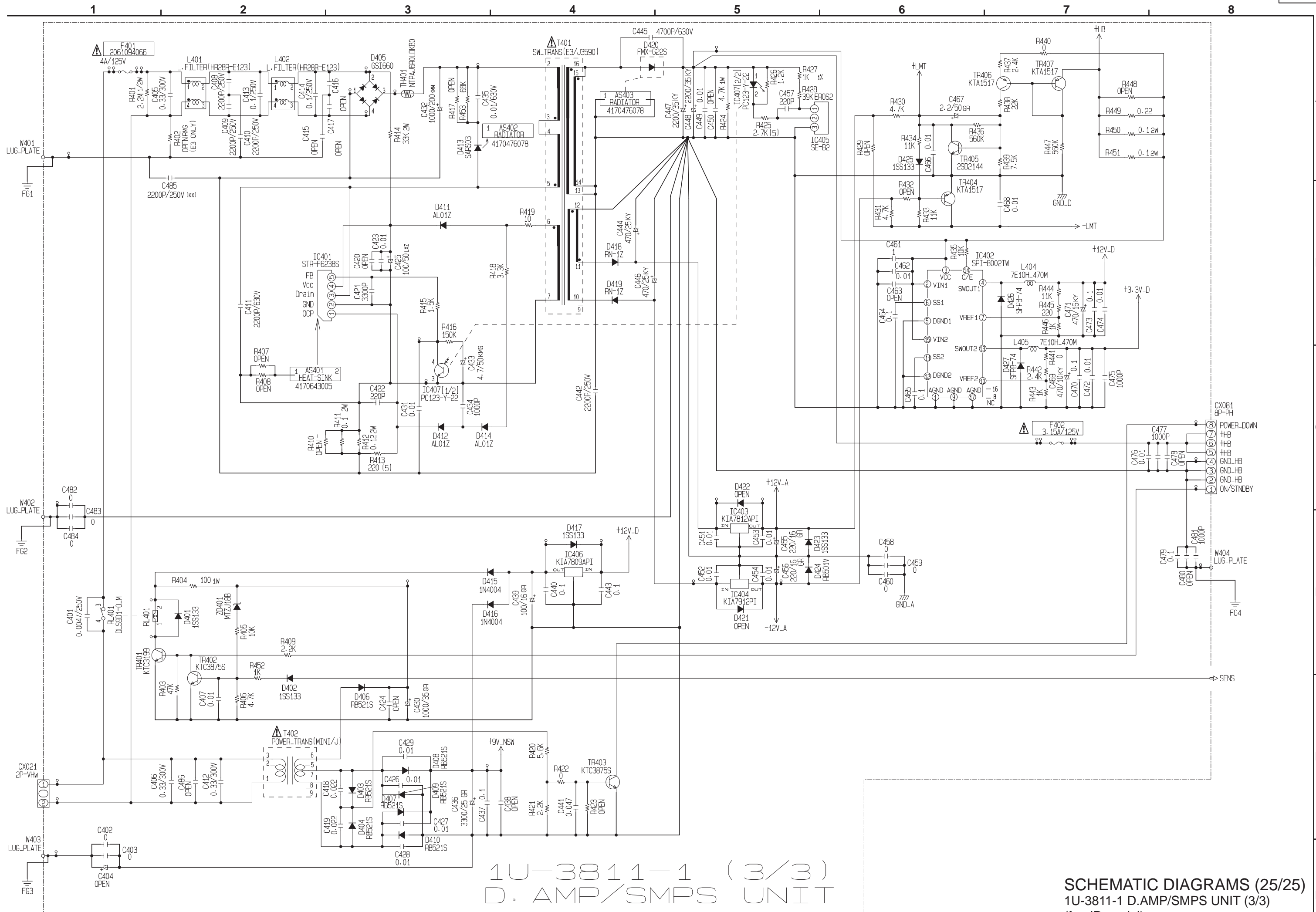

1U-3811-1 (3/3)  
D. AMP/SMPS UNIT